

# Tech-Specs Catalogue 2024

Technical Specifications  
& Configurations

# Tech-Specs Katalog 2024

Technische Spezifikationen  
& Ausführungen



# CONTENT/ INHALT

---

## LIVING/ WOHNEN

<b>Upholstery/ Polstermöbel</b>	<b>13 - 89</b>
<b>Chairs &amp; Dining Sofas/ Stühle &amp; Dining Sofas</b>	<b>90 - 109</b>
<b>Tables/ Tische</b>	<b>110 - 130</b>
<b>Accessories/ Accessoires</b>	<b>131 - 140</b>

## SLEEPING/ SCHLAFEN

<b>Design Line</b> Complete Beds/ Komplettbetten	<b>145 - 150</b>
<b>Classic Line</b> Complete Beds/ Komplettbetten	<b>151 - 156</b>
<b>Advanced Line</b> Modular Beds - Headboards/ Modulbetten - Kopfhäupter	<b>157 - 166</b>
<b>Advanced Line</b> Modular Beds - Bed Bases/ Modulbetten - Bettbasen	<b>160 - 171</b>
<b>Inserts/ Einsätze</b>	<b>172 - 175</b>
<b>Mattresses &amp; Toppers/ Matratzen &amp; Auflagen</b>	<b>176 - 186</b>

# CONTENT/ INHALT

## SINGLE SOFAS EINZELSOFAS

Alleegasse	15
Andes	18
Aura	25
Aura XL	26
Blocks	28
<b>NEWS</b> Bun	31
Camín Revisited	33
Club 1910	38
Colli	39
Constanze 3/4	40
Figure	43
Haus Koller	45
Havanna	46
Kubus	50
Merwyn Lounge	55
Miles Lounge	56
Oyster	59
Palais Stoclet	60
Paradise Bird	61
Paradise Bird Fullback	62
Paradise Bird Outdoor	63
Party Lounge	64
Playtime	68
Salon	76
Villa Gallia	78
Vuelta Sofa/ Sofa	82
Vuelta Lounge Sofa/ Lounge Sofa	83

## MODULAR SOFAS MODULARE SOFAS

Andes	17 - 20
<b>NEWS</b> Atrium	21 - 24
Blocks	27 - 29
Camín Revisited	32 - 37
Materassi	52 - 54
Playtime	65 - 75
<b>NEWS</b> Vuelta	86 - 89

## ARMCHAIRS & HIGHBACK CHAIRS FAUTEUILS & HOCHLEHNER

Alleegasse	15
Andes	16
Aura	25
Aura XL	26
Bonnie	30
<b>NEWS</b> Bun	31
Club 1910	38
Constanze 3/4	40
Contessa 1956	41
Fame	42
Figure	43
Freischwinger Nr.2	44
Haus Koller	45
Jolly Highback Chair/ Hochlehner	47
Jolly Cantilever Chair/ Freischwinger	48
Jolly ‚All in One‘	49
Kubus	50
Lilian	51
Merwyn Lounge	55
Miles Lounge	56
Mono	57
<b>NEWS</b> Morton Lounge	58
Oyster	59
Palais Stoclet	60
Paradise Bird	61
Paradise Bird Fullback	62
Paradise Bird Outdoor	63
Salon	76
Sitzmaschine	77
Villa Gallia	78
Vuelta Highback Chair/ Hochlehner	79
Vuelta Armchair/ Fauteuil	80

# CONTENT/ INHALT

## CHAIRS & DINING SOFAS STÜHLE & DINING SOFAS

Berlin	90
Carinzia	91
Fame	92
Fledermaus	93
<b>NEWS</b> Joseph	94
Leslie Chair/ Stuhl	95
Leslie Barstool/ Barstuhl	96
Merwyn Chair/ Stuhl	97
Merwyn Chair, Barstool/ Stuhl, Barstuhl	98
Merwyn Dining	99
Miles Dining	100
Mono	101
<b>NEWS</b> Morton	102
<b>NEWS</b> Morton FD	103
Nils	104
Odeon	105
Paradise Bird	106
Sedan	107
Toga	108
Vuelta FD	109

## BENCHES, POUFS & STOOLS BÄNKE, POUFS & HOCKER

Adagio Bench/ Bank	14
Adagio Pouf/ Pouf	13
Aura	25
Aura XL	26
Bonnie	30
Constanze 3/4	40
Contessa 1956	41
Fame	42
Jolly Stool/ Hocker	47
Jolly Cantilever Stool/ Freischwinger Hocker	48
Miles	56
Mono	57
Paradise Bird	61
Paradise Bird Outdoor	63
Vuelta Bench/ Bank	81
Vuelta Stool/ Hocker	79

## TABLES TISCHE

Acacia	110
<b>NEWS</b> Adèle	111
Andes	112
Antilles	113
Antilles Dining	114
Baton	115
Contessa 1956	116
DD Table	117
Detour	118
Grain Cut Table	119
Helice Table	120
Leather Side Table	121
Merwyn	122
Miles Table/ Tisch	123
Miles Bistro-, High Table/ Bistro-, Stehtisch	124
Paradise Bird Coffee Table/ Couchtisch	125
Paradise Bird Desk/ Schreibtisch	126
Paradise Bird Outdoor	127
Sattische	128
Sticks Table	129
Tuky	130

## ACCESSORIES ACCESSOIRES

Acacia	131
Antigua	132
Baton	133
Cushions/ Kissen	140
Detour	134
Forme	135
MD Shelf	136
Monkey Mirror	137
Ouvert	138
<b>NEWS</b> Tact	139



# SINGLE SOFAS/ EINZELSOFAS



ALLEEGASSE



ANDES



AURA



AURA XL



BLOCKS



NEWS  
BUN



CAMIN REVISITED



CLUB 1910



COLLI



CONSTANZE 3/4



FIGURE



HAUS KOLLER



HAVANNA



KUBUS



MERWYN LOUNGE



MILES LOUNGE



OYSTER



PALAIS STOCLET



PARADISE BIRD



PARADISE BIRD  
FULLBACK



PARADISE BIRD  
OUTDOOR



PLAYTIME



PARTY LOUNGE



SALON



VILLA GALLIA

## SINGLE SOFAS/ EINZELSOFAS

---



VUELTA Sofa  
VUELTA Sofa



VUELTA Lounge Sofa  
VUELTA Lounge Sofa

## MODULAR SOFAS/ MODULARE SOFAS

---



ANDES



NEWS

ATRIUM



BLOCKS



CAMIN REVISITED



MATERASSI



PLAYTIME



NEWS

VUELTA

# ARMCHAIRS & HIGHBACK CHAIRS/ FAUTEUILS & HOCHLEHNER



ALLEEGASSE



ANDES



AURA



AURA XL



BONNIE



NEWS

BUN



CLUB 1910



CONSTANZE 3/4



CONTESSA 1956



FAME



FIGURE



FREISCHWINGER NR.2



HAUS KOLLER



JOLLY Highback Chair  
JOLLY Hochlehner



JOLLY Cantilever Chair  
JOLLY Freischwinger



JOLLY ‚ALL IN ONE‘



KUBUS



LILIAN



MERWYN LOUNGE



MILES LOUNGE



MONO



NEWS

MORTON LOUNGE



OYSTER



PALAIS STOCLET



PARADISE BIRD

## ARMCHAIRS & HIGHBACK CHAIRS/ FAUTEUILS & HOCHLEHNER

---



**PARADISE BIRD**  
**FULLBACK**



**PARADISE BIRD**  
**OUTDOOR**



**SALON**



**SITZMASCHINE**



**VILLA GALLIA**



**VUELTA** Highback Chair  
**VUELTA** Hochlehner



**VUELTA** Armchair  
**VUELTA** Fauteuil

# CHAIRS & DINING SOFAS/ STÜHLE & DINING SOFAS



**BERLIN**



**CARINZIA**



**FAME**



**FLEDERMAUS**



**NEWS**

**JOSEPH**



**LESLIE Chair/ Stuhl**



**LESLIE Barstool/ Barstuhl**



**MERWYN Chair/ Stuhl**



**MERWYN**  
Chair, Barstool/  
Stuhl, Barstuhl



**MERWYN DINING**



**MILES DINING**



**MONO**



**NEWS**  
**MORTON**



**NEWS**  
**MORTON FD**



**NILS**



**ODEON**



**PARADISE BIRD**



**SEDAN**



**TOGA**



**VUELTA FD**

**BENCHES, POUFS & STOOLS / BÄNKE, POUFS & HOCKER**



**ADAGIO** Bench/ *Bank*



**ADAGIO** Pouf



**AURA**



**AURA XL**



**BONNIE**



**CONSTANZE 3/4**



**CONTESSA 1956**



**FAME**



**JOLLY** Stool/ *Hocker*



**JOLLY** Cantilever stool/  
*Freischwinger Hocker*



**MILES**



**MONO**



**PARADISE BIRD**



**PARADISE BIRD  
OUTDOOR**



**VUELTA** Bench/ *Bank*



**VUELTA** Stool/ *Hocker*

# TABLES/ TISCHE

---



ACACIA



**NEWS**  
ADÈLE



ANDES



ANTILLES



ANTILLES DINING



BATON



CONTESSA 1956



DD TABLE



DETOUR



GRAIN CUT TABLE



HELICE TABLE



LEATHER SIDE TABLE



MERWYN



MILES

Side-, Coffee Table/  
Beistell-, Couchtisch



MILES

Bistro-, High Table/  
Bistro-, Stehtisch



PARADISE BIRD  
Coffee Table/  
Couchtisch



PARADISE BIRD  
Desk/ Schreibtisch



PARADISE BIRD  
OUTDOOR



SATZTISCHE



STICKS TABLE



TUKY



# ACCESSORIES/ ACCESSOIRES



ACACIA



ANTIGUA



Cushions  
*Kissen*



BATON



DETOUR

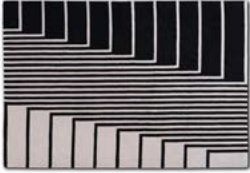

FORME - SCALA



FORME - SELLA



FORME - CHESS



FORME - BLOCK



MD SHELF

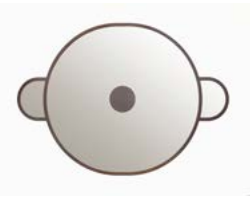

MONKEY MIRROR



OUVERT



NEWS

TACT



# ADAGIO Design: Note

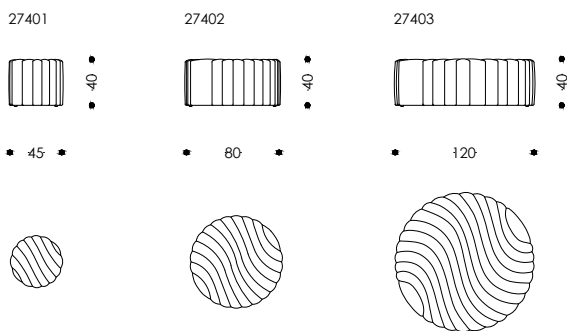

## Detailed Corner View/ Detaillierte Kantensicht

Fabric Cover/ Stoffbezug

Leather Cover/ Lederbezug

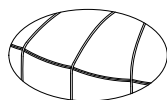

Stitched fixed cover with seams/  
Gesteppter Fixbezug mit Steppnaht

Fixed cover with piping/  
Fixbezug mit Keder

	27401	27402	27403
<b>Seat width in cm:</b> <b>Sitzbreite in cm:</b>	Ø45	Ø80	Ø120
<b>Seat width in inches:</b> <b>Sitzbreite in inches:</b>	Ø17,72	Ø31,50	Ø47,24
<b>Seat depth in cm:</b> <b>Sitztiefe in cm:</b>	Ø45	Ø80	Ø120
<b>Seat depth in inches:</b> <b>Sitztiefe in inches:</b>	Ø17,72	Ø31,50	Ø47,24
<b>WxDxH(SH) in inches:</b>	Ø17,72x15,75	Ø31,50x15,75	Ø47,24x15,75

## Configurations

<b>Frame:</b>	Wooden construction
<b>Feet:</b>	Black plastic feet with felt glides
<b>Upholstery:</b>	
Pouf 45:	Polyurethane foams sandwich layered with dacron overlay
Pouf 80, 120:	Pocket springs, polyurethane foams sandwich layered with dacron overlay
<b>Cover:</b>	
Fabric:	Stitched fixed cover with seams
Leather:	Fixed cover with piping
<b>Piping:</b>	Same as cover (only for leather cover)

## Ausführungen

<b>Gestell:</b>	Holzkonstruktion
<b>FüÙe:</b>	Schwarze KunststofffüÙe mit Filzgleiter
<b>Polsterung:</b>	
Hocker 45:	Polymousse Sandwichaufbau mit Vliesabdeckung
Hocker 80, 120:	Taschenfederkern, Polymousse Sandwichaufbau mit Vliesabdeckung
<b>Bezug:</b>	
Stoff:	Gesteppter Fixbezug mit Steppnaht
Leder:	Fixbezug mit Keder
<b>Keder:</b>	Wie Bezug (nur bei Lederbezug)

# ADAGIO Design: Note

27404

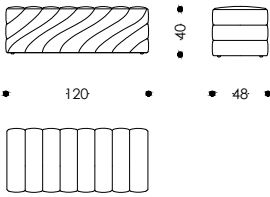

27405

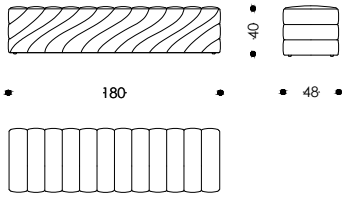

27406

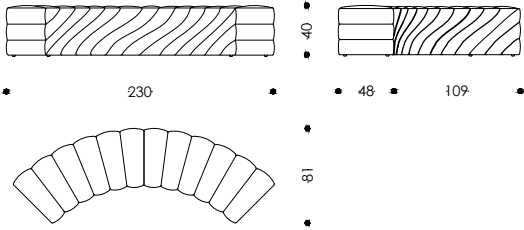

Seat height and foot height/ Sitzhöhe und Fußhöhe

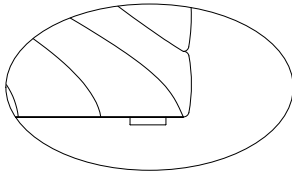

Seat height 40cm/ Sitzhöhe 40cm

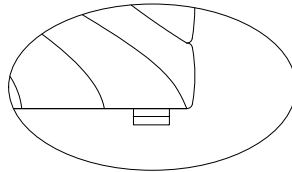

Seat height 43cm/ Sitzhöhe 43cm

**For element groups please attach a drawing to the order/ Bei einer Gruppenbestellung ist unbedingt eine Skizze beizufügen**  
**Due to upholstery technique, all fabrics are processed with selvedge/ Aufgrund der Polstertechnik werden alle Stoffe Webkante verarbeitet**

	27404	27405	27406
<b>Seat width in cm:</b> <i>Sitzbreite in cm:</i>	120	180	223
<b>Seat width in inches:</b> <i>Sitzbreite in inches:</i>	47,74	70,87	87,79
<b>Seat depth in cm:</b> <i>Sitztiefe in cm:</i>	48	48	48
<b>Seat depth in inches:</b> <i>Sitztiefe in inches:</i>	18,90	18,90	18,90
<b>WxDxH(SH) in inches:</b>	47,24x18,90x15,75	70,87x18,90x15,75	87,79x18,90x15,75

## Configurations

<b>Frame:</b>	Wooden construction
<b>Feet:</b>	Black plastic feet with felt glides
<b>Seat height:</b>	40cm
Without surcharge:	43cm with foot-modules
<b>Upholstery:</b>	Pocket springs, polyurethane foams sandwich layered with dacron overlay
<b>Cover:</b>	Fixed cover in fabric with stitched seams

## Ausführungen

<b>Gestell:</b>	Holzkonstruktion
<b>FüÙe:</b>	Schwarze KunststofffüÙe mit Filzgleiter
<b>Sitzhöhe:</b>	40cm
Auf Wunsch:	43cm mit Fußmodulen
<b>Polsterung:</b>	Taschenfederkern, Polymousse Sandwichaufbau mit Vliesabdeckung
<b>Bezug:</b>	Fixbezug in Stoff mit Steppnaht

# ALLEEGASSE Recreation Josef Hoffmann (Design: 1912)

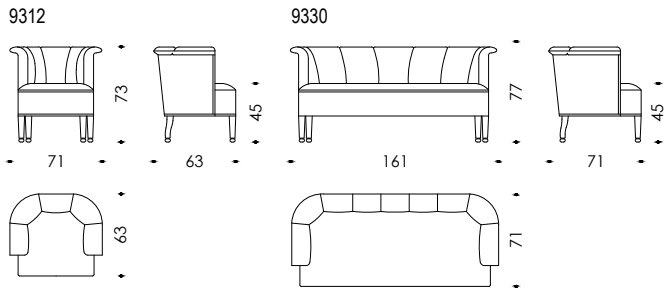

	9312	9330
<b>Seat width in cm:</b> <i>Sitzbreite in cm:</i>	46	132
<b>Seat width in inches:</b> <i>Sitzbreite in inches:</i>	18,11	51,97
<b>Seat depth in cm:</b> <i>Sitztiefe in cm:</i>	45	51
<b>Seat depth in inches:</b> <i>Sitztiefe in inches:</i>	17,72	20,08
<b>WxDxH(SH) in inches:</b>	27,95x24,80x28,74(17,72)	64,17x27,95x30,31(17,72)

Configurations	Ausführungen
<b>Frame:</b> Wooden construction	<b>Gestell:</b> Holzkonstruktion
<b>Legs:</b> Beech solid, Black	<b>Beine:</b> Buche massiv, Schwarz
<b>Upholstery:</b>	<b>Polsterung:</b>
<b>Seat:</b> Fixed webbing with coil springs and Jute overlay, Polyurethane foams and Latex sandwich layered with dacron overlay	<b>Sitz:</b> Starre Begurtung mit Federkern und Juteabdeckung, Polymousse und Latex Sandwichaufbau mit Vliesabdeckung
<b>Arm-/Backrest:</b> Elastic webbing, polyurethane foams sandwich layered with dacron overlay	<b>Arm-/Rückenlehne:</b> Elastische Begurtung, Polymousse Sandwichaufbau mit Vliesabdeckung
<b>Cover:</b> Fixed cover with piping or braid	<b>Bezug:</b> Fixbezug mit Keder oder Borte
<b>Piping:</b> Same as cover	<b>Keder:</b> wie Bezug
<b>Without surcharge:</b> Leather in standard colours Color Atlantic, Black, Cognac, Dark grey, Mocca, Sand, Siena and Taupe	<b>Auf Wunsch:</b> Leder in Standardfarben Color Atlantic, Black, Cognac, Dark grey, Mocca, Sand, Siena und Taupe
<b>Braid:</b> Black	<b>Borte:</b> Schwarz
<b>Without surcharge:</b> Black&White	<b>Auf Wunsch:</b> Schwarz&Weiß
<b>Surcharge:</b> Matching the fabric (single-/ two-tone)	<b>Aufpreis:</b> passend zum Stoff (ein-/ zweifärbig)
<b>Cover in Streif 4:</b> Fixed cover with piping or braid	<b>Bezug in Streif 4:</b> Fixbezug mit Keder oder Borte
<b>Piping:</b> Streif 4 fabric uni-black or uni-white without surcharge	<b>Keder:</b> Streif 4 Stoff Uni-Schwarz oder Uni-Weiß auf Wunsch
<b>Braid:</b> Black or Black&White without surcharge	<b>Borte:</b> Schwarz oder Schwarz&Weiß auf Wunsch

# ANDES Design: Luca Nichetto

26927

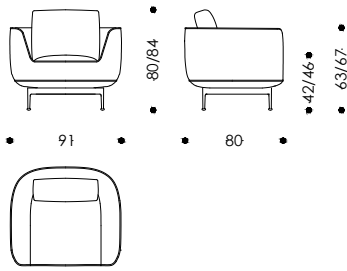

26930

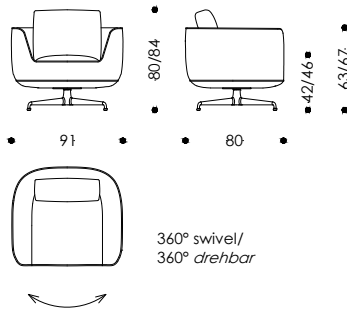

	26927	26930
<b>Seat width in cm:</b> <i>Sitzbreite in cm:</i>	53	53
<b>Seat width in inches:</b> <i>Sitzbreite in inches:</i>	20,87	20,87
<b>Seat depth in cm:</b> <i>Sitztiefe in cm:</i>	47	47
<b>Seat depth in inches:</b> <i>Sitztiefe in inches:</i>	18,50	18,50
<b>WxDxH(SH) in inches:</b>	35,83x31,50x31,50(16,54)	35,83x31,50x31,50(16,54)

## Configurations

<b>Frame:</b>	Metal- wooden construction
<b>Seat height:</b>	42cm
Without surcharge:	46cm
<b>Legs:</b>	Metal Black Grey with leather fiber glides
Surcharge:	Brass Satin Matt
<b>Upholstery:</b>	
Armrest, Backrest:	Polyurethane foams sandwich layered with dacron overlay
Seat:	Fixed webbing, pocket springs, polyurethane foams sandwich layered with dacron overlay
Backrest cushion:	100% feather filling with polyurethane core
<b>Cover:</b>	
Corpus:	Fixed cover with piping
Cushion:	Same as corpus, removable
<b>Piping:</b>	Same as cover
Without surcharge:	Leather in standard colours Color Atlantic, Black, Cognac, Dark grey, Mocca, Sand, Siena and Taupe

## Ausführungen

<b>Gestell:</b>	<i>Metall- Holzkonstruktion</i>
<b>Sitzhöhe:</b>	42cm
<i>Auf Wunsch:</i>	46cm
<b>Beine:</b>	<i>Metall Black Grey mit Lederfasergleitern</i>
<i>Aufpreis:</i>	<i>Messing Satin Matt</i>
<b>Polsterung:</b>	
<i>Armteil, Lehne:</i>	<i>Polymousse Sandwichaufbau mit Vliesabdeckung</i>
<i>Sitz:</i>	<i>Starre Begurtung, Taschenfederkern, Polymousse Sandwichaufbau mit Vliesabdeckung</i>
<i>Lehnkissen:</i>	<i>100% Federnfüllung mit Polymousse Kern</i>
<b>Bezug:</b>	
<i>Korpus:</i>	<i>Fixbezug mit Keder</i>
<i>Kissen:</i>	<i>Wie Korpus, abnehmbar</i>
<b>Keder:</b>	<i>Wie Bezug</i>
<i>Auf Wunsch:</i>	<i>Leder in Standardfarben Color Atlantic, Black, Cognac, Dark grey, Mocca, Sand, Siena und Taupe</i>

# ANDES Design: Luca Nichetto

## Combination Examples/ Kombinationsbeispiele

Combination Example 1/ Kombinationsbeispiel 1

1x Chaise Longue 190 L/ Chaiselongue 190 L (26907)  
1x Special Element 125 L/ Sonderelement 125 L (26909)

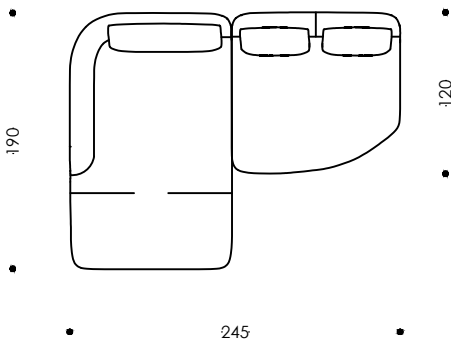

Combination Example 2/ Kombinationsbeispiel 2

1x End Element 277 L/ Abschlusselement 277 L (26905)  
1x Chaise Longue 190 R/ Chaiselongue 190 R (26908)

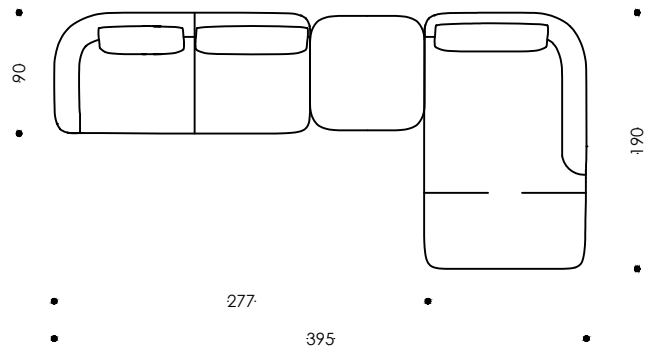

Combination Example 3/ Kombinationsbeispiel 3

1x Middle Element 170 deep/ Zwischenelement 170 tief (26917)  
1x End Element 190 deep R/ Abschlusselement 190 tief R (26918)

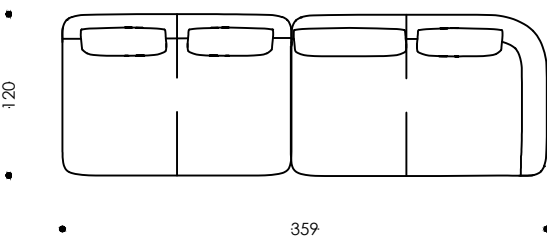

Combination Example 4/ Kombinationsbeispiel 4

1x End Element 190 R/ Abschlusselement 190 R (26904)  
1x End Element 277 R/ Abschlusselement 277 R (26906)

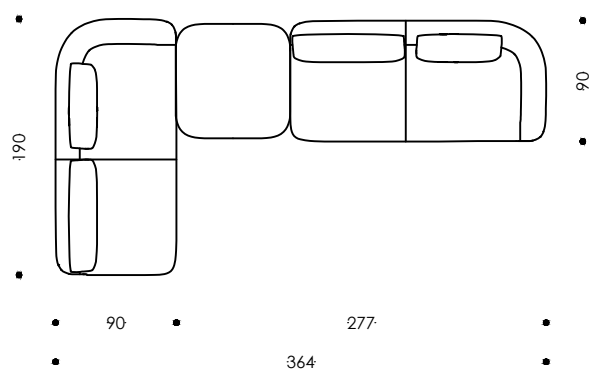

Combination Example 5/ Kombinationsbeispiel 5

1x End Element 277 R/ Abschlusselement 277 R (26906)  
1x End Element 190 R/ Abschlusselement 190 R (26904)

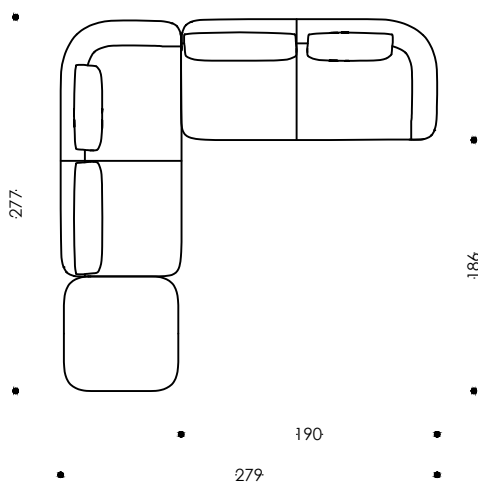

Combination Example 6/ Kombinationsbeispiel 6

1x Chaise Longue 190 L/ Chaiselongue 190 L (26907)  
1x End Element 190 R/ Abschlusselement 190 R (26904)

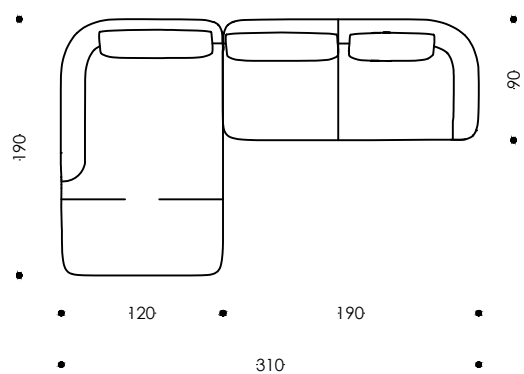

# ANDES Design: Luca Nichetto

26900

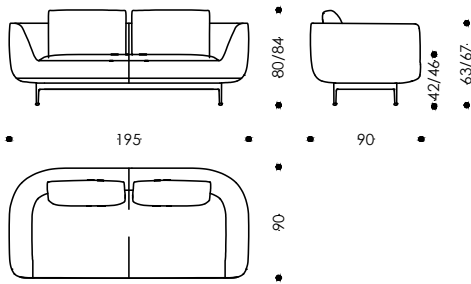

26901

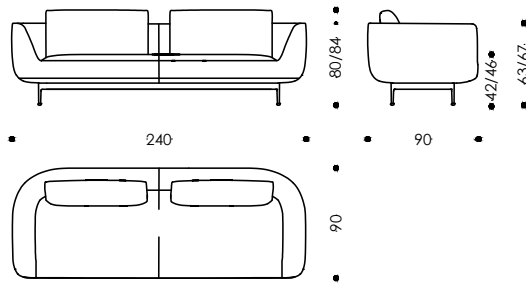

26911

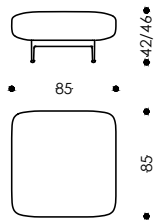

26920

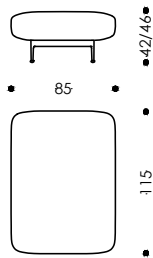

	26900	26901	26911	26920
<b>Seat width in cm:</b> <i>Sitzbreite in cm:</i>	152	197	85	85
<b>Seat width in inches:</b> <i>Sitzbreite in inches:</i>	59,84	77,56	33,46	33,46
<b>Seat depth in cm:</b> <i>Sitztiefe in cm:</i>	56	56	85	115
<b>Seat depth in inches:</b> <i>Sitztiefe in inches:</i>	22,05	22,05	33,46	45,28
<b>WxDxH(SH) in inches:</b>	76,77x35,43x31,50(16,54)	94,49x35,43x31,50(16,54)	33,46x33,46x16,54	33,46x45,28x16,54

## Configurations

<b>Frame:</b>	Metal- wooden construction
<b>Seat height:</b>	42cm
Without surcharge:	46cm
<b>Legs:</b>	Metal Black Grey with leather fiber glides
Surcharge:	Brass Satin Matt
<b>Upholstery:</b>	
Arm-, Backrest:	Polyurethane foams sandwich layered with dacron overlay
Seat:	Fixed webbing, pocket springs, polyurethane foams sandwich layered with dacron overlay
Backrest cushion:	100% feather filling with polyurethane core
<b>Cover:</b>	
Corpus:	Fixed cover with piping
Cushion:	Same as corpus, removable
<b>Piping:</b>	Same as cover
Without surcharge:	Leather in standard colours Color Atlantic, Black, Cognac, Dark grey, Mocca, Sand, Siena and Taupe

## Ausführungen

<b>Gestell:</b>	Metall- Holzkonstruktion
<b>Sitzhöhe:</b>	42cm
Auf Wunsch:	46cm
<b>Beine:</b>	Metall Black Grey mit Lederfasergleitern
Aufpreis:	Messing Satin Matt
<b>Polsterung:</b>	
Arm-, Rückenlehne:	Polymousse Sandwichaufbau mit Vliesabdeckung
Sitz:	Starre Begurtung, Taschenfederkern, Polymousse Sandwichaufbau mit Vliesabdeckung
Lehnkissen:	100% Federnfüllung mit Polymousse Kern
<b>Bezug:</b>	
Korpus:	Fixbezug mit Keder
Kissen:	Wie Korpus, abnehmbar
<b>Keder:</b>	Wie Bezug
Auf Wunsch:	Leder in Standardfarben Color Atlantic, Black, Cognac, Dark grey, Mocca, Sand, Siena und Taupe

# ANDES Design: Luca Nichetto

26904 (R)/26903 (L)

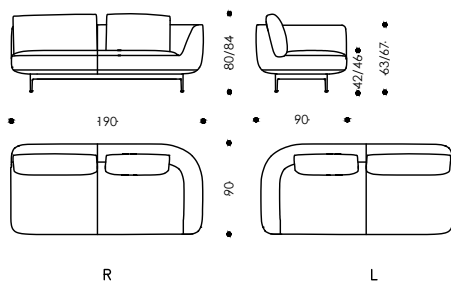

26906 (R)/26905 (L)

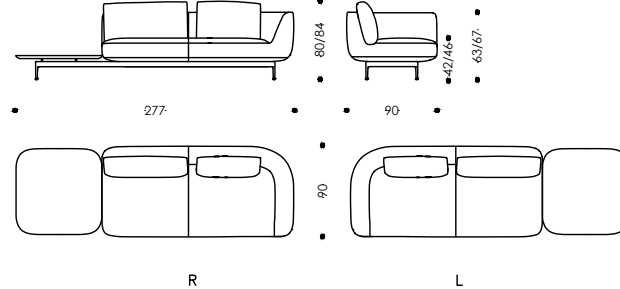

26918 (R)/26919 (L)

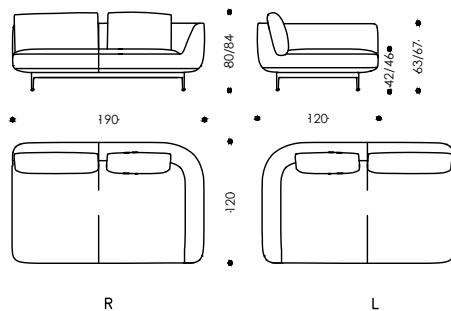

26908 (R)/26907 (L)

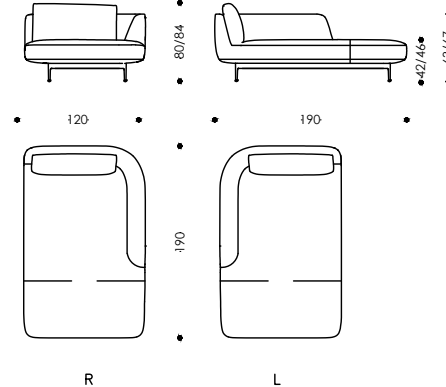

For element groups please attach a drawing to the order/ Bei einer Gruppenbestellung ist unbedingt eine Skizze beizufügen

	26904/26903	26906/26905	26918/26919	26908/26907
Seat width in cm: Sitzbreite in cm:	170	170	170	100
Seat width in inches: Sitzbreite in inches:	66,93	66,93	66,93	39,37
Seat depth in cm: Sitztiefe in cm:	56	56	86	156
Seat depth in inches: Sitztiefe in inches:	22,05	22,05	33,86	64,42
WxDxH(SH) in inches:	74,80x35,43x31,50(16,54)	109,06x35,43x31,50(16,54)	74,80x47,24x31,50(16,54)	47,24x74,80x31,50(16,54)

## Configurations

<b>Frame:</b>	Metal- wooden construction
<b>Seat height:</b>	42cm
Without surcharge:	46cm
<b>Legs:</b>	Metal Black Grey with leather fiber glides
Surcharge:	Brass Satin Matt
<b>Tray:</b>	Walnut veneer
Surcharge:	Marble Frappuccino
<b>Upholstery:</b>	
Arm-, Backrest:	Polyurethane foams sandwich layered with dacron overlay
Seat:	Fixed webbing, pocket springs, polyurethane foams sandwich layered with dacron overlay
Backrest cushion:	100% feather filling with polyurethane core
<b>Cover:</b>	
Corpus:	Fixed cover with piping
Cushion:	Removable cover, same as corpus
<b>Piping:</b>	Same as cover
Without surcharge:	Leather in standard colours Color Atlantic, Black, Cognac, Dark grey, Mocca, Sand, Siena and Taupe

## Ausführungen

<b>Gestell:</b>	Metall- Holzkonstruktion
<b>Sitzhöhe:</b>	42cm
Auf Wunsch:	46cm
<b>Beine:</b>	Metall Black Grey mit Lederfasergleitern
Aufpreis:	Messing Satin Matt
<b>Ablage:</b>	Nuss furniert
Aufpreis:	Marmor Frappuccino
<b>Polsterung:</b>	
Arm-, Rückenlehne:	Polymousse Sandwichaufbau mit Vliesabdeckung
Sitz:	Starre Begurtung, Taschenfederkern, Polymousse Sandwichaufbau mit Vliesabdeckung
Lehnkissen:	100% Federnfüllung mit Polymousse Kern
<b>Bezug:</b>	
Korpus:	Fixbezug mit Keder
Kissen:	Bezug abnehmbar, wie Korpus
<b>Keder:</b>	Wie Bezug
Auf Wunsch:	Leder in Standardfarben Color Atlantic, Black, Cognac, Dark grey, Mocca, Sand, Siena und Taupe

# ANDES Design: Luca Nichetto

26902

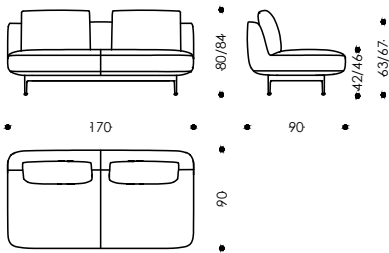

26917

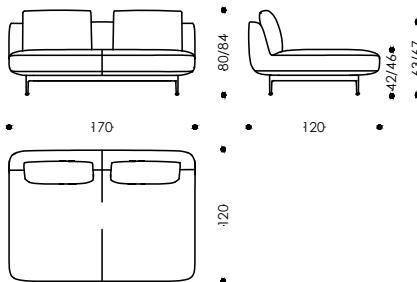

26910 (R)/26909 (L)

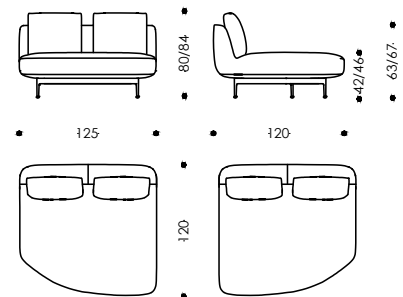

26924

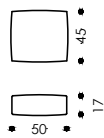

26915

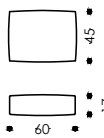

26916

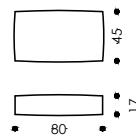

For element groups please attach a drawing to the order/ Bei einer Gruppenbestellung ist unbedingt eine Skizze beizufügen

	26902	26917	26910/26909	26924	26915	26916
Seat width in cm: <i>Sitzbreite in cm:</i>	170	170	125	-	-	-
Seat width in inches: <i>Sitzbreite in inches:</i>	66,93	66,93	49,21	-	-	-
Seat depth in cm: <i>Sitztiefe in cm:</i>	56	86	56 - 86	-	-	-
Seat depth in inches: <i>Sitztiefe in inches:</i>	22,05	33,86	22,05 - 33,86	-	-	-
WxDxH(SH) in inches:	66,93x35,43x 31,50(16,54)	66,93x47,24x 31,50(16,54)	49,21x47,24x 31,50(16,54)	19,69x6,69x17,72	23,62x6,69x17,72	31,50x6,69x17,72

## Configurations

<b>Frame:</b>	Metal- wooden construction
<b>Seat height:</b>	42cm
Without surcharge:	46cm
<b>Legs:</b>	Metal Black Grey with leather fiber glides
Surcharge:	Brass Satin Matt
<b>Upholstery:</b>	
Arm-, Backrest:	Polyurethane foams sandwich layered with dacron overlay
Seat:	Fixed webbing, pocket springs, polyurethane foams sandwich layered with dacron overlay
Backrest cushion:	100% feather filling with polyurethane core
<b>Cover:</b>	
Corpus:	Fixed cover with piping
Cushion:	Same as corpus, removable
<b>Piping:</b>	Same as cover
Without surcharge:	Leather in standard colours Color Atlantic, Black, Cognac, Dark grey, Mocca, Sand, Siena and Taupe

## Ausführungen

<b>Gestell:</b>	Metall- Holzkonstruktion
<b>Sitzhöhe:</b>	42cm
Auf Wunsch:	46cm
<b>Beine:</b>	Metall Black Grey mit Lederfasergleitern
Aufpreis:	Messing Satin Matt
<b>Polsterung:</b>	
Arm-, Rückenlehne:	Polymousse Sandwichaufbau mit Vliesabdeckung
Sitz:	Starre Begurtung, Taschenfederkern, Polymousse Sandwichaufbau mit Vliesabdeckung
Lehnkissen:	100% Federnfüllung mit Polymousse Kern
<b>Bezug:</b>	
Korpus:	Fixbezug mit Keder
Kissen:	Wie Korpus, abnehmbar
<b>Keder:</b>	Wie Bezug
Auf Wunsch:	Leder in Standardfarben Color Atlantic, Black, Cognac, Dark grey, Mocca, Sand, Siena und Taupe



# ATRIUM Design: Wittmann Workshop

## Upholstery Construction/ Polsteraufbau

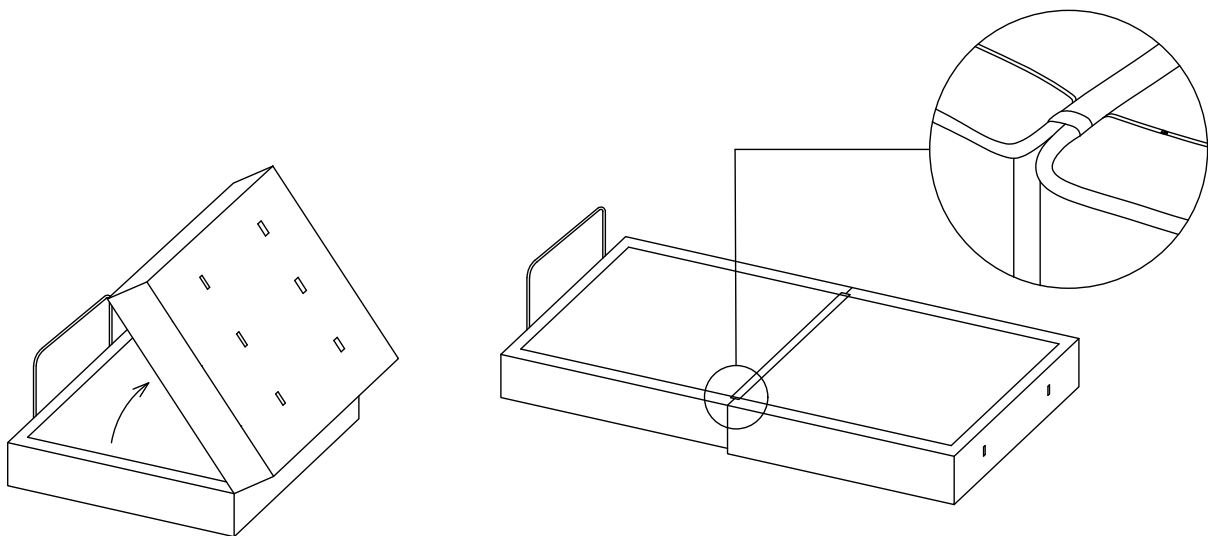
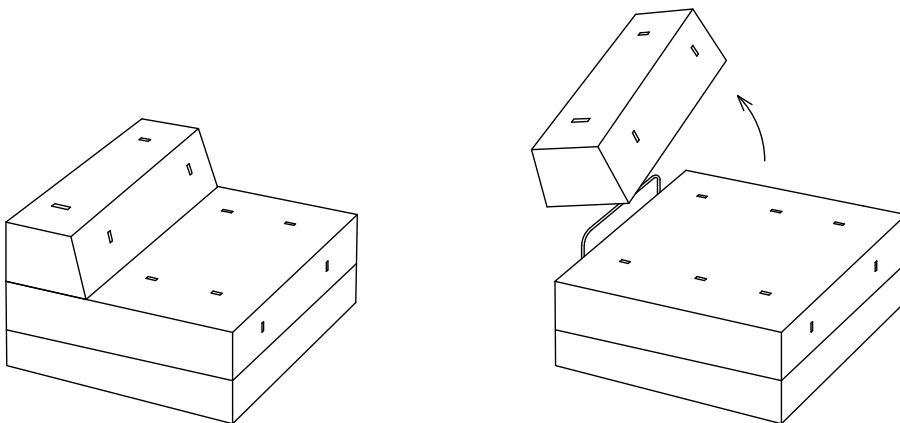
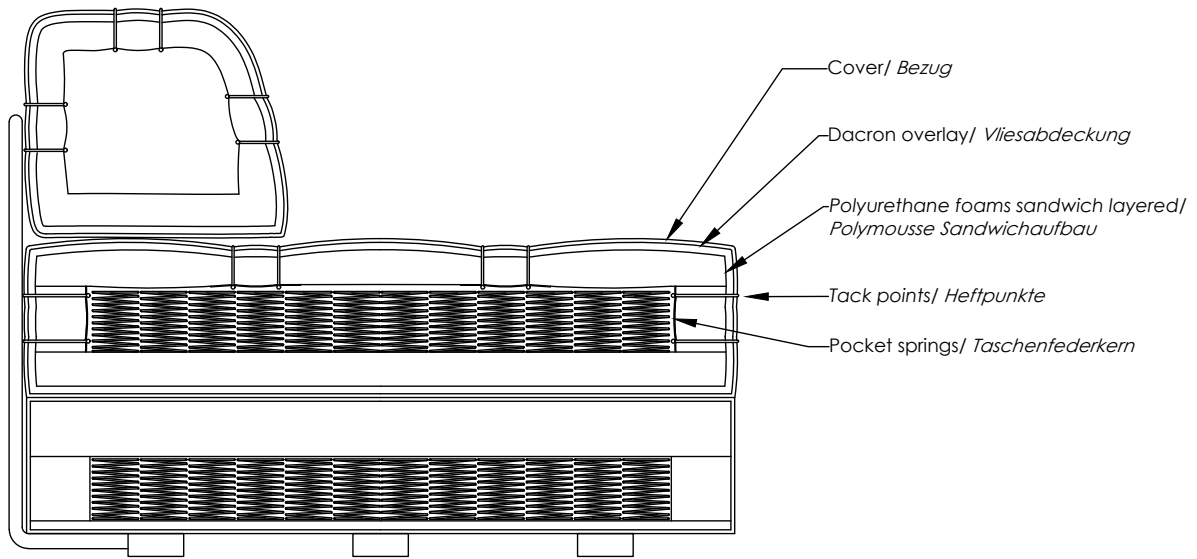

## Combination Examples/ *Kombinationsbeispiele*

### Combination Example 1/ *Kombinationsbeispiel 1*

1x Double Element/ *Doppelement* (27920)  
 1x Tray Element/ *Ablageelement* (27990)

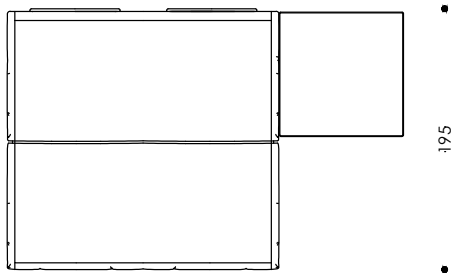
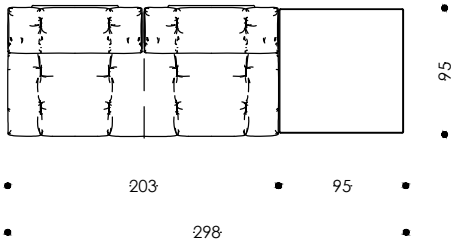

*Double Element as double bed/  
 Doppelement als Doppelbett*

### Combination Example 2/ *Kombinationsbeispiel 2*

1x Single Element/ *Einzelement* (27912)  
 1x Tray Element/ *Ablageelement* (27990)  
 1x Double Element/ *Doppelement* (27920)

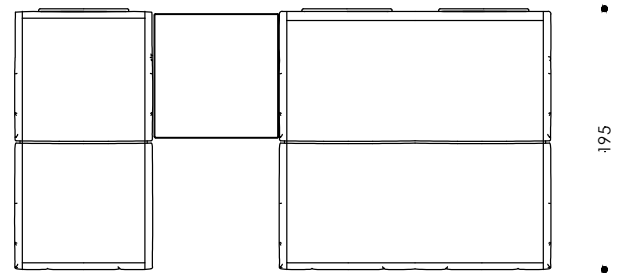
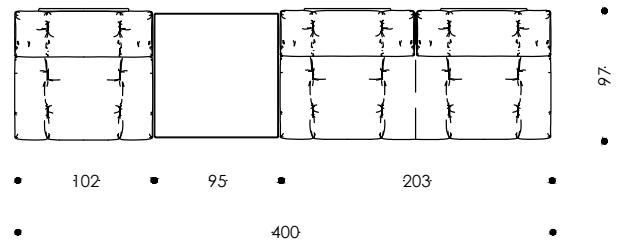

*Single element as single bed/  
 Einzelement als Einzelbett*

*Double Element as double bed/  
 Doppelement als Doppelbett*

### Combination Example 3/ *Kombinationsbeispiel 3*

1x Single Element/ *Einzelement* (27912)  
 1x Chest Element/ *Truhenelement* (27991)  
 1x Double Element/ *Doppelement* (27920)  
 1x Tray Element/ *Ablageelement* (27990)

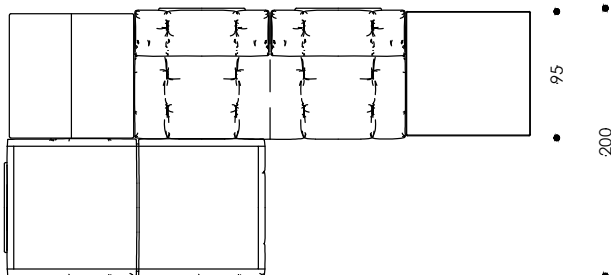
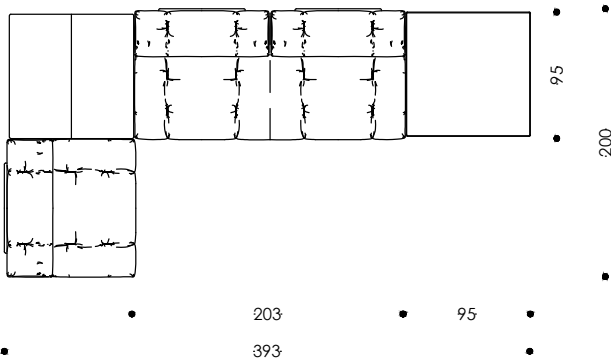

*Single element as single bed/  
 Einzelement als Einzelbett*

*Double Element as double bed/  
 Doppelement als Doppelbett*

# ATRIUM Design: Wittmann Workshop

27912

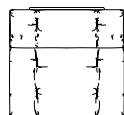
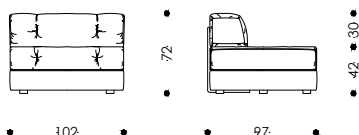

Single element as single bed/ Einzelement als Einzelbett

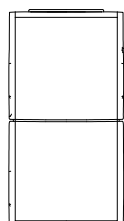
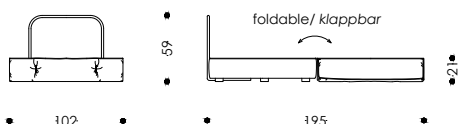

27920

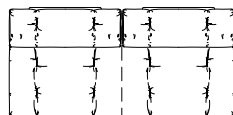
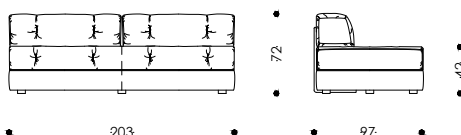

Double Element as double bed/ Doppelement als Doppelbett

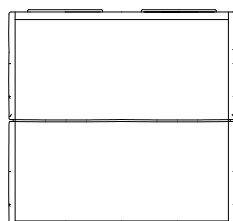
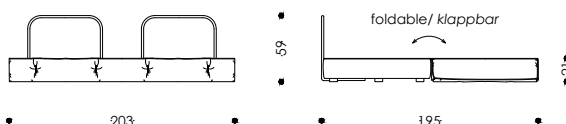

For an elegant fold-formation, the use of elastic fabrics and soft leather is recommended/  
Für einen eleganten Faltenwurf wird die Verwendung von elastischen Stoffen und weichem Leder empfohlen

For element groups please attach a drawing to the order/ Bei einer Gruppenbestellung ist unbedingt eine Skizze beizufügen

	27912	27920
Seat width in cm: Sitzbreite in cm:	102	203
Seat width in inches: Sitzbreite in inches:	40,16	79,92
Seat depth in cm: Sitztiefe in cm:	62	62
Seat depth in inches: Sitztiefe in inches:	24,41	24,41
WxDxH(SH) in inches:	40,16x38,19x28,35(16,54)	79,92x38,19x28,35(16,54)

## Configurations

<b>Corpus:</b>	Wooden construction with black plastic feet and felt glides
<b>Frame:</b>	Metal pipe, Bronze
<b>Surcharge:</b>	In Chrome or Wittmann standard RAL colours
<b>Upholstery:</b>	
<b>Seat, Seat base:</b>	Pocket springs, polyurethane foams sandwich layered with dacron overlay
<b>Back Cushion:</b>	Loose cushion with polyurethane foams and dacron overlay
<b>Cover:</b>	Fixed cover with piping
<b>Fabric:</b>	Concealed tacking
<b>Leather:</b>	Tacked with leather band
<b>Lying surface:</b>	Drill fabric black
<b>Surcharge:</b>	Same as cover (only for fabric cover)
<b>Piping: (Seat, Seat base)</b>	Same as cover

## Ausführungen

<b>Korpus:</b>	Holzkonstruktion mit Kunststofffüßen Schwarz und Filzgleitern
<b>Bügel:</b>	Metallrohr, Bronze
<b>Aufpreis:</b>	In Chrom oder Wittmann Standard RAL Farben
<b>Polsterung:</b>	
<b>Sitz, Sitzbasis:</b>	Taschenfederkern, Polymousse Sandwichaufbau mit Vliesabdeckung
<b>Lehnkissen:</b>	Loses Kissen mit Polymousse und Vliesabdeckung
<b>Bezug:</b>	Fixbezug mit Keder
<b>Stoff:</b>	Blindheftung
<b>Leder:</b>	Geheftet mit Lederband
<b>Liegefläche:</b>	Drellstoff Schwarz
<b>Aufpreis:</b>	Wie Bezug (Nur bei Stoffbezug)
<b>Keder: (Sitz, Sitzbasis)</b>	Wie Bezug

# ATRIUM Design: Wittmann Workshop

27991

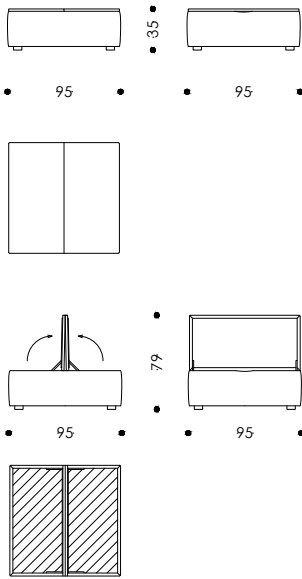

27990

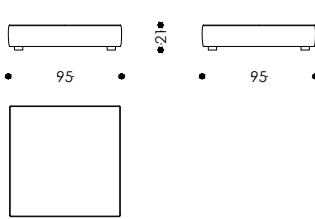

29491

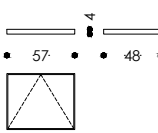

For Chest- and Tray Elements, it is recommended to use a tray/  
Für Truhen- und Ablageelement wird empfohlen, ein Tablett zu verwenden

For an elegant fold-formation, the use of elastic fabrics and soft leather is recommended/  
Für einen eleganten Faltenwurf wird die Verwendung von elastischen Stoffen und weichem Leder empfohlen

For element groups please attach a drawing to the order/ Bei einer Gruppenbestellung ist unbedingt eine Skizze beizufügen

	27991	27990	29491
<b>WxDxH in cm:</b>	95x95x35(79)	95x95x21	57x48x4
<b>BxTxH in cm:</b>			
<b>WxDxH in inches:</b>	37,40x37,40x13,78(31,10)	37,40x37,40x8,27	22,44x18,90x1,57

## Configurations

### Chest Element:

**Corpus:** Wooden construction with partition, black plastic legs with felt glides, lids equipped with black gas struts

**Cover:** Fixed cover, inside covered in felt antracite

### Tray Element:

**Corpus:** Wooden construction with black plastic feet and felt glides

**Cover:** Fixed cover with piping

**Piping:** Same as cover

**Tray:** Leather covered

## Ausführungen

### Truhenelement:

**Korpus:** Holzkonstruktion mit Trennwand, Kunststofffüße Schwarz mit Filzgleitern, Deckel mit schwarzen Gasdruckfedern ausgestattet

**Bezug:** Fixbezug, innen mit Filz Anthrazit bezogen

### Ablageelement:

**Korpus:** Holzkonstruktion mit Kunststofffüßen Schwarz und Filzgleitern

**Bezug:** Fixbezug mit Keder

**Keder:** Wie Bezug

**Ablage:** Lederbezogen

# AURA Design: Paolo Piva, 1983

1712

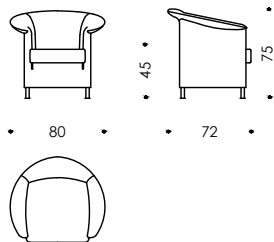

1717

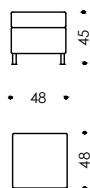

1720

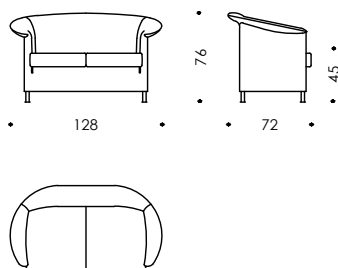

1725

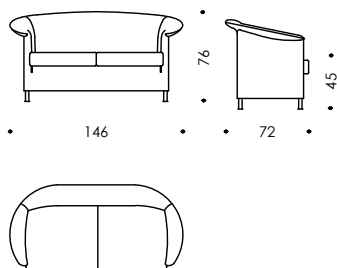

	1712	1717	1720	1725
<b>Seat width in cm:</b> <b>Sitzbreite in cm:</b>	45	48	92	110
<b>Seat width in inches:</b> <b>Sitzbreite in inches:</b>	17,72	18,90	36,22	43,31
<b>Seat depth in cm:</b> <b>Sitztiefe in cm:</b>	48	48	48	48
<b>Seat depth in inches:</b> <b>Sitztiefe in inches:</b>	18,90	18,90	18,90	18,90
<b>WxDxH(SH) in inches:</b>	31,50x28,35x29,53(18,90)	18,90x18,90x17,72	50,39x28,35x29,53(18,90)	57,48x28,35x29,53(18,90)

## Configurations

<b>Frame:</b>	Metal construction
<b>Legs:</b>	Beech solid Black with chrome-coloured glides
<b>Surcharge:</b>	In Wittmann standard RAL colours or with chrome sleeves
<b>Upholstery:</b>	
<b>Seat part:</b>	Linear wave springs with jute overlay and polyurethane foams with dacron overlay
<b>Seat cushion:</b>	Polyurethane foams with dacron overlay
<b>Back part:</b>	Elastic webbing, polyurethane foams with dacron overlay
<b>Cover:</b>	Fixed cover with piping and zipper on the rear side
<b>Surcharge:</b>	Removable cover (fabric only)
<b>Piping:</b>	Same as cover
<b>Without surcharge:</b>	Leather in standard colours Color Atlantic, Black, Cognac, Dark grey, Mocca, Sand, Siena and Taupe

## Ausführungen

<b>Gestell:</b>	Metallkonstruktion
<b>Beine:</b>	Buche massiv Schwarz mit chromfarbenen Gleitern
<b>Aufpreis:</b>	In Wittmann Standard RAL Farben oder mit Chromhülsen
<b>Polsterung:</b>	
<b>Sitzteil:</b>	Wellenfederung mit Juteabdeckung und Polymousse mit Vliesabdeckung
<b>Sitzkissen:</b>	Polymousse mit Vliesabdeckung
<b>Lehnteil:</b>	Elastische Begurtung, Polymousse mit Vliesabdeckung
<b>Bezug:</b>	Fixbezug mit Keder und Zipp auf der Rückseite
<b>Aufpreis:</b>	Bezug abnehmbar (Nur Stoff)
<b>Keder:</b>	Wie Bezug
<b>Auf Wunsch:</b>	Leder in Standardfarben Color Atlantic, Black, Cognac, Dark grey, Mocca, Sand, Siena und Taupe

# AURA XL Design: Paolo Piva, 1983

1742

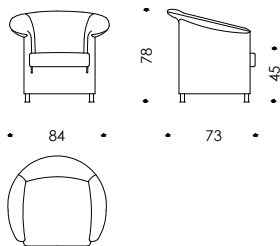

1747

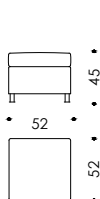

1760

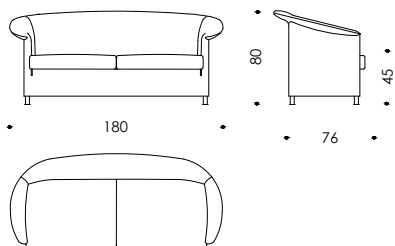

	1742	1747	1760
<b>Seat width in cm:</b> <i>Sitzbreite in cm:</i>	49	52	145
<b>Seat width in inches:</b> <i>Sitzbreite in inches:</i>	19,29	20,47	57,09
<b>Seat depth in cm:</b> <i>Sitztiefe in cm:</i>	52	52	52
<b>Seat depth in inches:</b> <i>Sitztiefe in inches:</i>	20,47	20,47	20,47
<b>WxDxH(SH) in inches:</b>	33,07x28,74x30,71(17,72)	18,90x18,90x17,72	70,87x29,92x31,50(17,72)

## Configurations

<b>Frame:</b>	Metal construction
<b>Legs:</b>	Beech solid Black with chrome-coloured glides
<b>Surcharge:</b>	In Wittmann standard RAL colours or with chrome sleeves
<b>Upholstery:</b>	
<b>Seat part:</b>	Linear wave springs with jute overlay and polyurethane foams with dacron overlay
<b>Seat cushion:</b>	Polyurethane foams with dacron overlay
<b>Back part:</b>	Elastic webbing, polyurethane foams with dacron overlay
<b>Cover:</b>	Fixed cover with piping and zipper on the rear side
<b>Surcharge:</b>	Removable cover (fabric only)
<b>Piping:</b>	Same as cover
<b>Without surcharge:</b>	Leather in standard colours Color Atlantic, Black, Cognac, Dark grey, Mocca, Sand, Siena and Taupe

## Ausführungen

<b>Gestell:</b>	Metallkonstruktion
<b>Beine:</b>	Buche massiv Schwarz mit chromfarbenen Gleitern
<b>Aufpreis:</b>	In Wittmann Standard RAL Farben oder mit Chromhülsen
<b>Polsterung:</b>	
<b>Sitzteil:</b>	Wellenfederung mit Juteabdeckung und Polymousse mit Vliesabdeckung
<b>Sitzkissen:</b>	Polymousse mit Vliesabdeckung
<b>Lehnteil:</b>	Elastische Begurtung, Polymousse mit Vliesabdeckung
<b>Bezug:</b>	Fixbezug mit Keder und Zipp auf der Rückseite
<b>Aufpreis:</b>	Bezug abnehmbar (Nur Stoff)
<b>Keder:</b>	Wie Bezug
<b>Auf Wunsch:</b>	Leder in Standardfarben Color Atlantic, Black, Cognac, Dark grey, Mocca, Sand, Siena und Taupe

# BLOCKS Design: Neri&Hu

## Combination Examples/ *Kombinationsbeispiele*

Combination Example 1/ *Kombinationsbeispiel 1*  
 4x Quarter Element/ *Viertel-element* (22203)

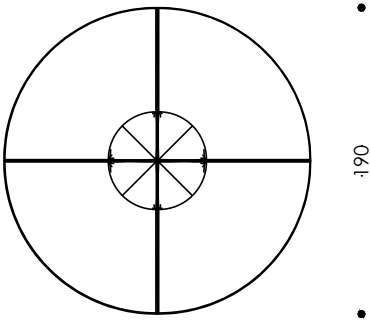

Combination Example 2/ *Kombinationsbeispiel 2*  
 2x Corner Element/ *Eckelement* (22201)  
 1x Stool Element/ *Hockerelement* (22204)

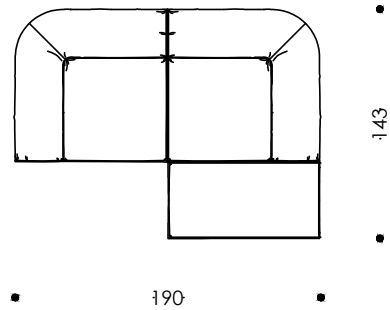

Combination Example 3/ *Kombinationsbeispiel 3*  
 2x Corner Element/ *Eckelement* (22201)  
 1x Middle Element/ *Zwischenelement* (22202)  
 1x Table Element/ *Tischelement* (22206)

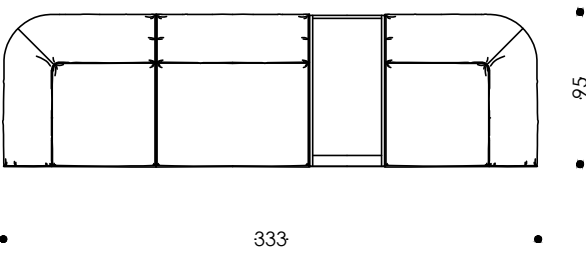

Combination Example 4/ *Kombinationsbeispiel 4*  
 1x Sofa 285/ *Sofa 285* (22220)  
 1x Middle Element/ *Zwischenelement* (22202)  
 1x Table Element/ *Tischelement* (22206)

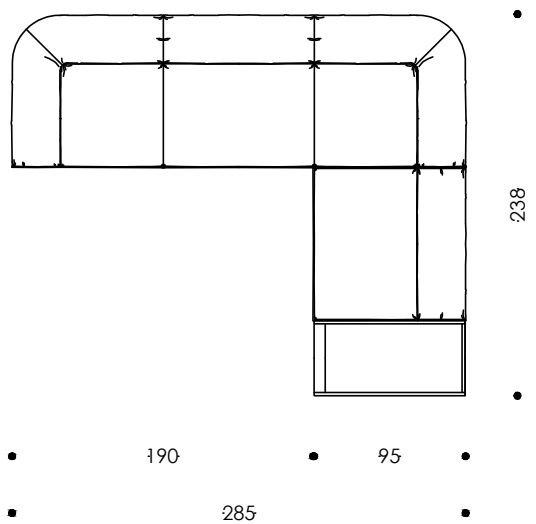

Combination Example 5/ *Kombinationsbeispiel 5*  
 2x Corner Element/ *Eckelement* (22201)  
 1x Stool Element/ *Hockerelement* (22204)  
 1x Table Element/ *Tischelement* (22206)  
 2x Middle Element/ *Zwischenelement* (22202)  
 2x Quarter Element/ *Viertel-element* (22203)

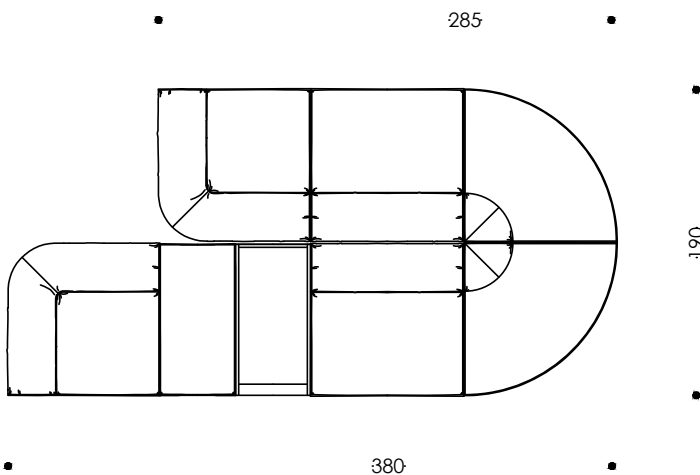

# BLOCKS Design: Neri&Hu

22220

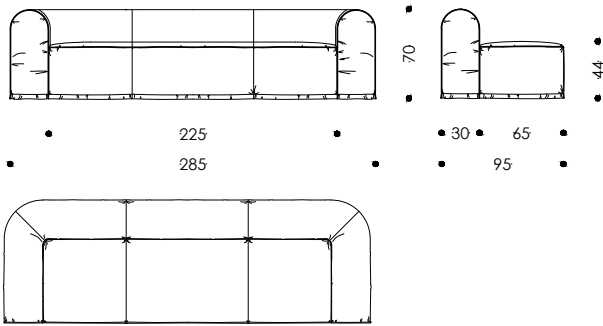

22201

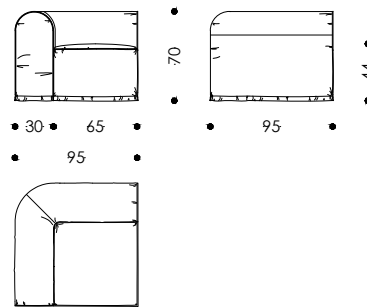

305

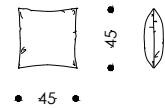

22202

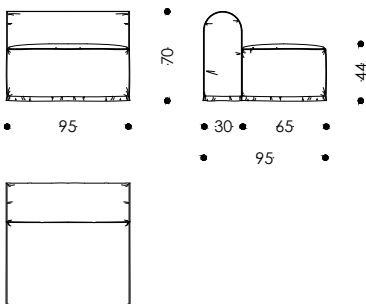

22203

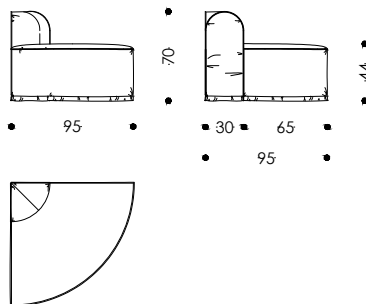

22204

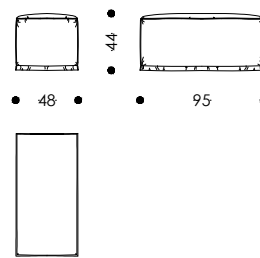

For element groups please attach a drawing to the order/ Bei einer Gruppenbestellung ist unbedingt eine Skizze beizufügen

	22220	22201	22202	22203	22204	305
Seat width in cm: Sitzbreite in cm:	225	65	95	65	95	-
Seat width in inches: Sitzbreite in inches:	88,58	25,59	37,40	25,59	37,40	-
Seat depth in cm: Sitztiefe in cm:	65	65	65	65	48	-
Seat depth in inches: Sitztiefe in inches:	25,59	25,59	25,59	25,59	18,90	-
WxDxH(SH) in inches:	112,21x37,40x 27,56(17,32)	37,40x37,40x 27,65(17,32)	37,40x37,40x 27,65(17,32)	37,40x37,40x 27,65(17,32)	18,90x37,40x16,54	17,32x17,32

## Configurations

<b>Frame:</b>	Wooden construction with black plastic feet and felt glides
<b>Upholstery:</b>	
<b>Seat:</b>	Fixed webbing with pocket springs, polyurethane foams sandwich layered with dacron overlay
<b>Arm-/Backrest:</b>	Polyurethane foams sandwich layered with dacron overlay
<b>Cushion:</b>	Feather filling with foam flakes
<b>Cover:</b>	Fixed cover
<b>Surcharge:</b>	Removable cover (fabric only)

## Ausführungen

<b>Gestell:</b>	Holzkonstruktion mit Kunststofffüßen Schwarz und Filzgleiter
<b>Polsterung:</b>	
<b>Sitz:</b>	Starre Begurtung mit Taschenfederkern, Polymousse Sandwichaufbau mit Vliesabdeckung
<b>Arm-/Rückenlehne:</b>	Polymousse Sandwichaufbau mit Vliesabdeckung
<b>Spitzkissen:</b>	Federnfüllung mit Schaumstofflocken
<b>Bezug:</b>	Fixbezug
<b>Aufpreis:</b>	Bezug abnehmbar (Nur Stoff)



# BLOCKS Design: Neri&Hu

22206

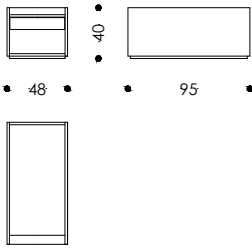

For element groups please attach a drawing to the order/ *Bei einer Gruppenbestellung ist unbedingt eine Skizze beizufügen*

22206	
<b>WxDxH in cm:</b>	48x95x40
<b>BxTxH in cm:</b>	
<b>WxDxH in inches:</b>	18,90x37,40x15,75

## Configurations

<b>Frame:</b>	Wooden construction with drawer and black wooden base with felt glides
<b>Corpus:</b>	Ash Black veneer
<b>Surcharge:</b>	Walnut solid
<b>Tabletop:</b>	Same as corpus
<b>Surcharge:</b>	Wireless charger mounted on tabletop bottom side, marked on top surface

## Ausführungen

<b>Gestell:</b>	Holzkonstruktion mit Lade und schwarzem Holzsockel mit Filzgleiter
<b>Korpus:</b>	Esche Schwarz furniert
<b>Aufpreis:</b>	Nuss massiv
<b>Tischplatte:</b>	Wie Korpus
<b>Aufpreis:</b>	Induktives Ladegerät montiert an der Unterseite, gekennzeichnet an der Tischoberseite

# BONNIE Design: Polka

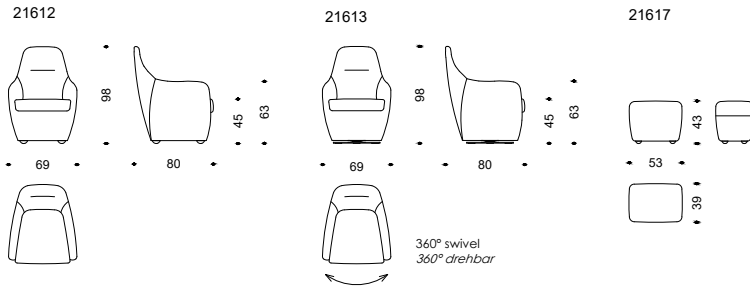

	21612	21613	21617
<b>Seat width in cm:</b> <i>Sitzbreite in cm:</i>	53	53	53
<b>Seat width in inches:</b> <i>Sitzbreite in inches:</i>	20,87	20,87	20,87
<b>Seat depth in cm:</b> <i>Sitztiefe in cm:</i>	55	55	39
<b>Seat depth in inches:</b> <i>Sitztiefe in inches:</i>	21,65	21,65	15,35
<b>WxDxH(SH) in inches:</b>	27,17x31,50x38,58(17,72)	27,17x31,50x38,58(17,72)	20,87x15,35x17,72

## Configurations

### Frame:

Highback Chair:	Metal construction
Stool:	Wooden construction
<b>Feet (21612):</b>	Beech solid Black with Teflon glides
<b>Feet (21613):</b>	Metal swivel base in black with felt glides
<b>Upholstery:</b>	
Seat:	Elastic webbing and polyurethane foams
Seat cushion:	Pocket springs and polyurethane foams with dacron overlay
Back-/Armrest:	Polyurethane foams with dacron overlay
Stool:	Polyurethane foams with dacron overlay
<b>Cover:</b>	Fixed cover

## Ausführungen

### Gestell:

<i>Hochlehner:</i>	<i>Metallkonstruktion</i>
<i>Hocker:</i>	<i>Holzkonstruktion</i>
<b><i>FüÙe (21612):</i></b>	<i>Buche massiv Schwarz mit Teflingleitern</i>
<b><i>FüÙe (21613):</i></b>	<i>Metall Drehteller Schwarz mit Filzgleitern</i>
<b>Polsterung:</b>	
<i>Sitz:</i>	<i>Elastische Begurtung und Polymousse</i>
<i>Sitzkissen:</i>	<i>Taschenfederkern und Polymousse mit Vliesabdeckung</i>
<i>Rücken-/Arملهne:</i>	<i>Polymousse mit Vliesabdeckung</i>
<i>Hocker:</i>	<i>Polymousse mit Vliesabdeckung</i>
<b>Bezug:</b>	<i>Fixbezug</i>

# BUN Design: Federica Biasi

28312

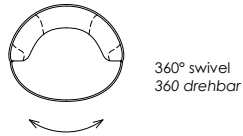
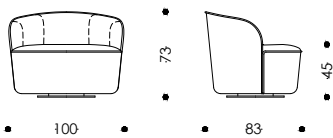

28320

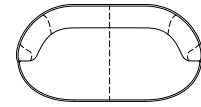
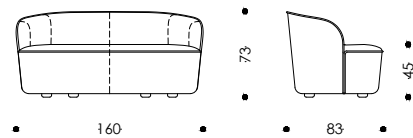

28325

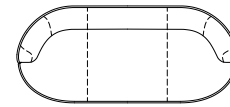
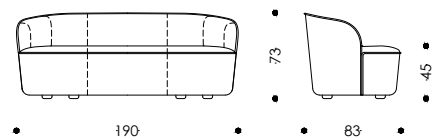

28330

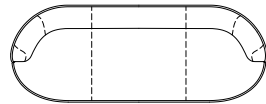
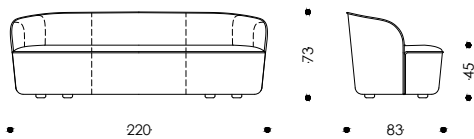

28335

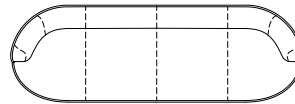
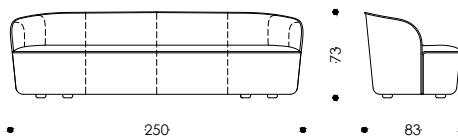

28300

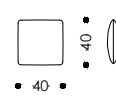

28301

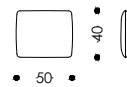

	28312	28320	28325	28330	28335	28300	28301
<b>Seat width in cm:</b> <i>Sitzbreite in cm:</i>	65	125	155	185	215	-	-
<b>Seat width in inches:</b> <i>Sitzbreite in inches:</i>	25,59	49,21	61,02	72,83	84,65	-	-
<b>Seat depth in cm:</b> <i>Sitztiefe in cm:</i>	63	63	63	63	63	-	-
<b>Seat depth in inches:</b> <i>Sitztiefe in inches:</i>	24,80	24,80	24,80	24,80	24,80	-	-
<b>WxDxH(SH) in inches:</b>	39,37x32,68x 28,74(17,72)	62,99x32,68x 28,74(17,72)	74,80x32,68x 28,74(17,72)	86,61x32,68x 28,74(17,72)	98,43x32,68x 28,74(17,72)	15,75x15,75	19,69x15,75

## Configurations

<b>Frame:</b>	Metal- wooden construction
<b>Base (Armchair):</b>	Metal swivel base, Black
<b>Base (Sofa):</b>	Black plastic feet with felt glides
<b>Upholstery:</b>	
<b>Seat:</b>	Fixed webbing, pocket springs and polyurethane foams sandwich layered with dacron overlay
<b>Back-/Armrest:</b>	Polyurethane foams sandwich layered with dacron overlay
<b>Cushion:</b>	Feather filling with foam flakes
<b>Cover:</b>	Fixed cover with flat piping
<b>Flat piping:</b>	Same as cover

## Ausführungen

<b>Gestell:</b>	Metall- Holzkonstruktion
<b>FüÙe (Fauteuil):</b>	Metall Drehteller, Schwarz
<b>FüÙe (Sofa):</b>	Schwarze KunststofffüÙe mit Filzgleitern
<b>Polsterung:</b>	
<b>Sitz:</b>	Starre Begurtung, Taschenfederkern und Polymousse Sandwichaufbau mit Vliesabdeckung
<b>Rücken-/Armlehne:</b>	Polymousse Sandwichaufbau mit Vliesabdeckung
<b>Zierkissen:</b>	Federnfüllung mit Schaumstofflocken
<b>Bezug:</b>	Fixbezug mit Biесе
<b>Biесе:</b>	Wie Bezug

# CAMIN REVISITED Recreation Paolo Piva, 2018

## Combination Examples/ *Kombinationsbeispiele*

### Combination Example 1/ *Kombinationsbeispiel 1*

- 1x Chaise Longue 260 Latex L/ Chaiselongue 260 Latex L (29409)
- 1x End Element 260 R/ Abschlusselement 260 R (29444)
- 1x Back Cushion 60/ Lehnkissen 60 (29450)
- 2x Back Cushion 120/ Lehnkissen 120 (29452)

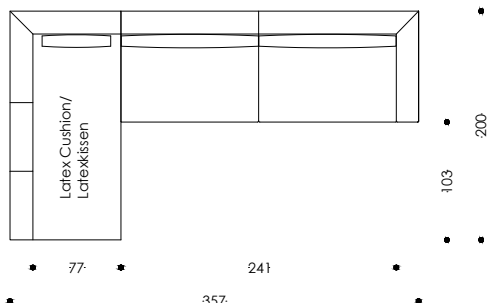

### Combination Example 2/ *Kombinationsbeispiel 2*

- 1x Sofa 280/ Sofa 280 (29430)
- 1x Chaise Longue 260 short L/ Chaiselongue 260 kurz L (29408)
- 1x Back Cushion 60/ Lehnkissen 60 (29450)
- 3x Back Cushion 90/ Lehnkissen 90 (29451)
- 1x Back Cushion 120/ Lehnkissen 120 (29452)

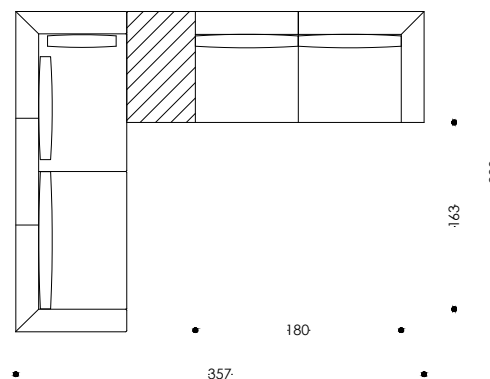

### Combination Example 3/ *Kombinationsbeispiel 3*

- 2x End Element 200 R/ Abschlusselement 200 R (29443)
- 1x Stool/ Hocker (29417)
- 4x Back Cushion 90/ Lehnkissen 90 (29451)

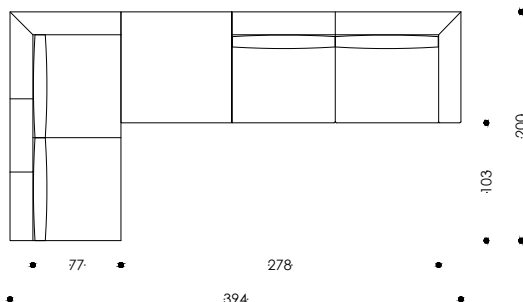

### Combination Example 4/ *Kombinationsbeispiel 4*

- 1x Stool/ Hocker (29417)
- 1x End Element 260 L/ Abschlusselement 260 L (29404)
- 1x Chaise Longue 260 Latex L/ Chaiselongue 260 Latex L (29460)
- 2x Back Cushion 90/ Lehnkissen 90 (29451)
- 2x Back Cushion 60/ Lehnkissen 60 (29450)

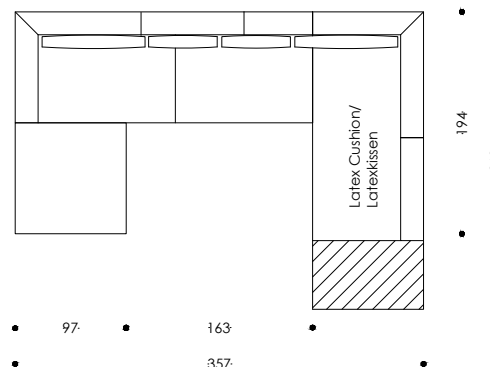

### Combination Example 5/ *Kombinationsbeispiel 5*

- 1x End Element 140 L/ Abschlusselement 140 L (29401)
- 1x End Element 260 L/ Abschlusselement 260 L (29404)
- 1x Chaise Longue 140 Latex R/ Chaiselongue 140 Latex R (29445)
- 2x Back Cushion 90/ Lehnkissen 90 (29451)
- 3x Back Cushion 120/ Lehnkissen 120 (29452)

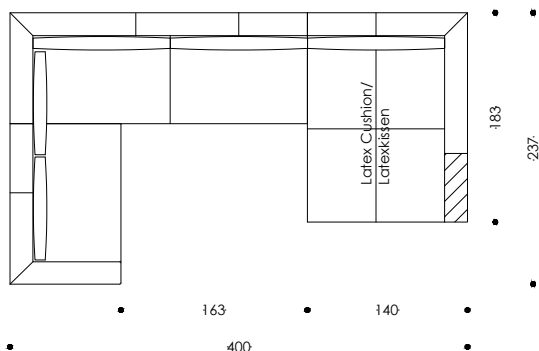

### Combination Example 6/ *Kombinationsbeispiel 6*

- 2x End Element 200 L/ Abschlusselement 200 L (29402)
- 1x Chaise Longue 260 Latex L/ Chaiselongue 260 Latex L (29409)
- 2x Back Cushion 60/ Lehnkissen 60 (29450)
- 6x Back Cushion 90/ Lehnkissen 90 (29451)

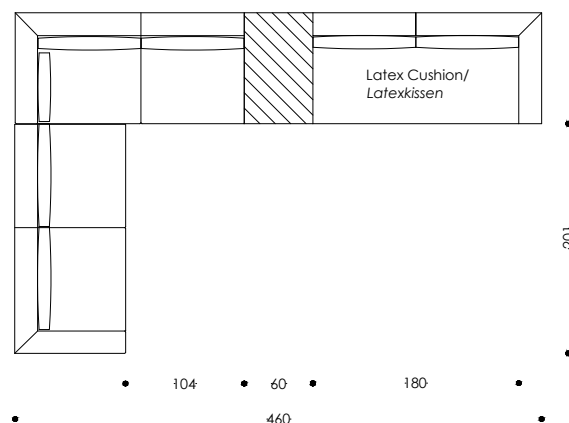

# CAMIN REVISITED Recreation Paolo Piva

29420

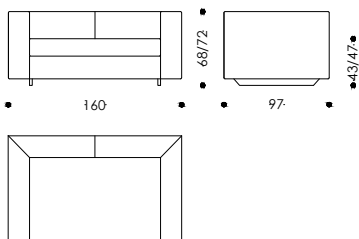

29425

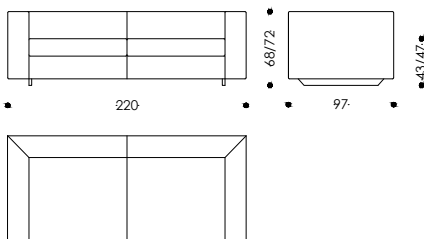

29426

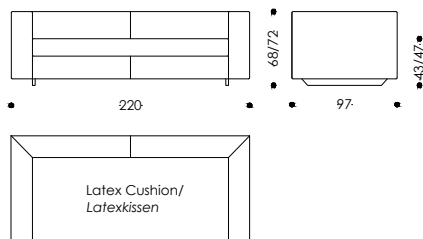

29430

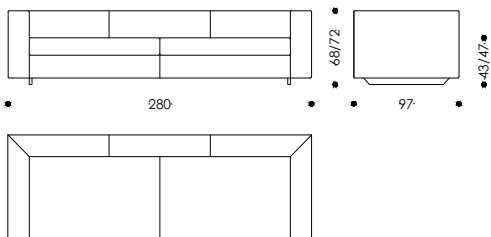

29417

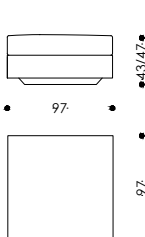

**Back cushions not included/ Lehnkissen nicht im Lieferumfang enthalten**

**For element groups please attach a drawing to the order/ Bei einer Gruppenbestellung ist unbedingt eine Skizze beizufügen**

**Depending on fabric-, leather requirement, the partition seams of seat and backrest are different/ Je nach Stoff- und Lederbedarf sind die Teilungsnähte in Sitz und Lehnkissen unterschiedlich**

	29420	29425	29426	29430	29417
<b>Seat width in cm:</b> <i>Sitzbreite in cm:</i>	120	180	180	240	97
<b>Seat width in inches:</b> <i>Sitzbreite in inches:</i>	47,24	70,87	70,87	94,49	38,19
<b>Seat depth in cm:</b> <i>Sitztiefe in cm:</i>	77	77	77	77	97
<b>Seat depth in inches:</b> <i>Sitztiefe in inches:</i>	30,31	30,31	30,31	30,31	38,19
<b>WxDxH(SH) in inches:</b>	62,99x38,19x26,77(16,93)	70,87x38,19x26,77(16,93)	70,87x38,19x26,77(16,93)	94,49x38,19x26,77(16,93)	38,19x38,19x26,77(16,93)

## Configurations

<b>Frame:</b>	Wooden construction
<b>Feet:</b>	Skids 6cm, Beech Black (Seat height 43cm)
<b>Surcharge:</b>	Skids 10cm, Beech Black (Seat height 47cm)
<b>Upholstery:</b>	
<b>Seat:</b>	Pocket springs and polyurethane foams
<b>Arm-, Backrest:</b>	Polyurethane foams with dacron overlay
<b>Seat cushion:</b>	Polyurethane foams sandwich layered with dacron overlay
<b>Seat cushion soft: (Surcharge)</b>	Feather-dacron cushion with cold foam core
<b>Cover:</b>	
<b>Corpus:</b>	Fixed cover
<b>Seat cushion:</b>	Same as corpus, removable cover

## Ausführungen

<b>Gestell:</b>	Holzkonstruktion
<b>FüÙe:</b>	Kufen 6cm, Buche Schwarz (Sitzhöhe 43cm)
<b>Aufpreis:</b>	Kufen 10cm, Buche Schwarz (Sitzhöhe 47cm)
<b>Polsterung:</b>	
<b>Sitz:</b>	Taschenfederkern und Polymousse
<b>Arm-, Rückenlehne:</b>	Polymousse mit Vliesabdeckung
<b>Sitzkissen:</b>	Polymousse Sandwichaufbau mit Vliesabdeckung
<b>Sitzkissen soft: (Aufpreis)</b>	Feder Vliesmatte mit Kaltschaumkern
<b>Bezug:</b>	
<b>Korpus:</b>	Fixbezug
<b>Sitzkissen:</b>	Wie Korpus, Bezug abnehmbar

# CAMIN REVISITED Recreation Paolo Piva

29441(R)/ 29401(L)

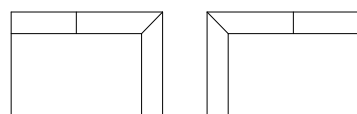
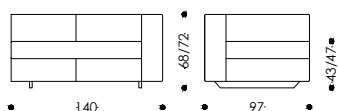

R

L

29443(R)/ 29402(L)

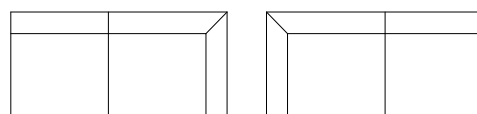
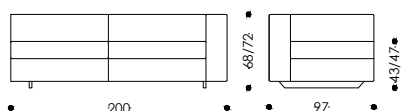

R

L

29442(R)/ 29403(L)

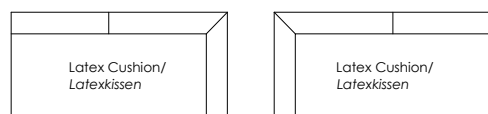
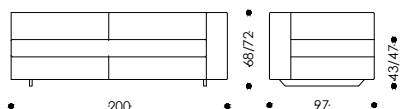

R

L

29444(R)/ 29404(L)

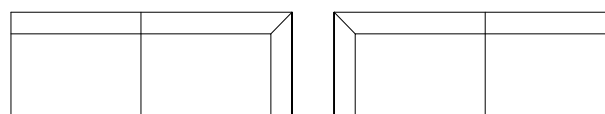
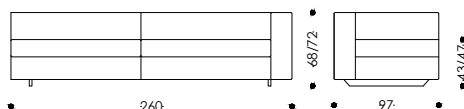

R

L

**Back cushions not included/ Lehnkissen nicht im Lieferumfang enthalten**

**For element groups please attach a drawing to the order/ Bei einer Gruppenbestellung ist unbedingt eine Skizze beizufügen**

**Depending on fabric-, leather requirement, the partition seams of seat and backrest are different/**

**Je nach Stoff- und Lederbedarf sind die Teilungsnähte in Sitz und Lehnkissen unterschiedlich**

	29441/ 29401	29443/ 29402	29442/ 29403	29444/ 29404
<b>Seat width in cm:</b> <i>Sitzbreite in cm:</i>	120	180	180	240
<b>Seat width in inches:</b> <i>Sitzbreite in inches:</i>	47,24	70,87	70,87	94,49
<b>Seat depth in cm:</b> <i>Sitztiefe in cm:</i>	77	77	77	77
<b>Seat depth in inches:</b> <i>Sitztiefe in inches:</i>	30,31	30,31	30,31	30,31
<b>WxDxH(SH) in inches:</b>	55,12x38,19x26,77(16,93)	78,74x38,19x26,77(16,93)	78,74x38,19x26,77(16,93)	102,36x38,19x26,77(16,93)

## Configurations

<b>Frame:</b>	Wooden construction
<b>Feet:</b>	Skids 6cm, Beech Black (Seat height 43cm)
<b>Surcharge:</b>	Skids 10cm, Beech Black (Seat height 47cm)
<b>Upholstery:</b>	
<b>Seat:</b>	Pocket springs and polyurethane foams
<b>Arm-, Backrest:</b>	Polyurethane foams with dacron overlay
<b>Seat cushion:</b>	Polyurethane foams sandwich layered with dacron overlay
<b>Seat cushion soft: (Surcharge)</b>	Feather-dacron cushion with cold foam core
<b>Cover:</b>	
<b>Corpus:</b>	Fixed cover
<b>Seat cushion:</b>	Same as corpus, removable cover

## Ausführungen

<b>Gestell:</b>	Holzkonstruktion
<b>FüÙe:</b>	Kufen 6cm, Buche Schwarz (Sitzhöhe 43cm)
<b>Aufpreis:</b>	Kufen 10cm, Buche Schwarz (Sitzhöhe 47cm)
<b>Polsterung:</b>	
<b>Sitz:</b>	Taschenfederkern und Polymousse
<b>Arm-, Rückenlehne:</b>	Polymousse mit Vliesabdeckung
<b>Sitzkissen:</b>	Polymousse Sandwichaufbau mit Vliesabdeckung
<b>Sitzkissen soft: (Aufpreis)</b>	Feder Vliesmatte mit Kaltschaumkern
<b>Bezug:</b>	
<b>Korpus:</b>	Fixbezug
<b>Sitzkissen:</b>	Wie Korpus, Bezug abnehmbar

# CAMIN REVISITED Recreation Paolo Piva

29446(R)/ 29405(L)

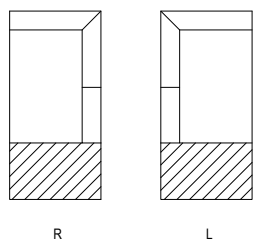
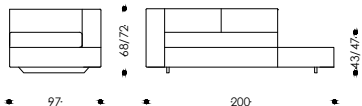

29448(R)/ 29407(L)

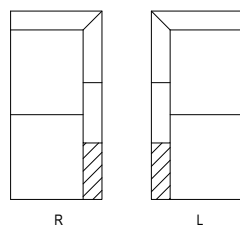
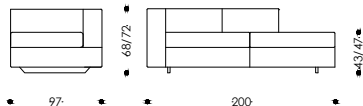

29447(R)/ 29406(L)

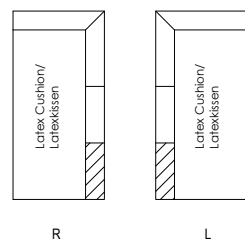
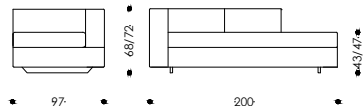

29449(R)/ 29408(L)

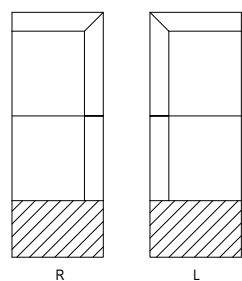
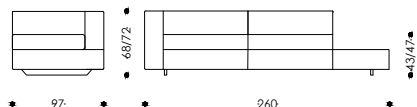

29461(R)/ 29410(L)

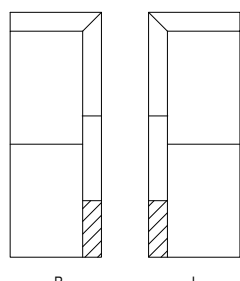
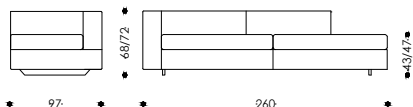

29460(R)/ 29409(L)

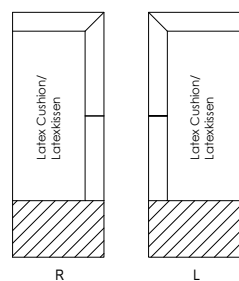
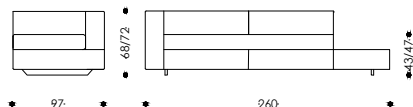

**Back cushions not included/ Lehnkissen nicht im Lieferumfang enthalten**

**For element groups please attach a drawing to the order/ Bei einer Gruppenbestellung ist unbedingt eine Skizze beizufügen**

**Depending on fabric-, leather requirement, the partition seams of seat and backrest are different/**

**Je nach Stoff- und Lederbedarf sind die Teilungsnähte in Sitz und Lehnkissen unterschiedlich**

	29446/ 29405	29448/ 29407	29447/ 29406	29449/ 29408	29461/ 29410	29447/ 29409
<b>Seat width in cm:</b> <i>Sitzbreite in cm:</i>	77	77	77	77	77	77
<b>Seat width in inches:</b> <i>Sitzbreite in inches:</i>	30,31	30,31	30,31	30,31	30,31	30,31
<b>Seat depth in cm:</b> <i>Sitztiefe in cm:</i>	120	180	180	180	200	180
<b>Seat depth in inches:</b> <i>Sitztiefe in inches:</i>	47,24	70,87	70,87	70,87	94,49	70,87
<b>WxDxH(SH) in inches:</b>	38,19x78,74x 26,77(16,93)	38,19x78,74x 26,77(16,93)	38,19x78,74x 26,77(16,93)	38,19x102,36 26,77(16,93)	38,19x102,36 26,77(16,93)	38,19x102,36 26,77(16,93)

## Configurations

<b>Frame:</b>	Wooden construction
<b>Feet:</b>	Skids 6cm, Beech Black (Seat height 43cm)
<b>Surcharge:</b>	Skids 10cm, Beech Black (Seat height 47cm)
<b>Upholstery:</b>	
<b>Seat:</b>	Pocket springs and polyurethane foams
<b>Arm-, Backrest:</b>	Polyurethane foams with dacron overlay
<b>Seat cushion:</b>	Polyurethane foams sandwich layered with dacron overlay
<b>Seat cushion soft:</b> (Surcharge)	Feather-dacron cushion with cold foam core
<b>Cover:</b>	
<b>Corpus:</b>	Fixed cover
<b>Seat cushion:</b>	Same as corpus, removable cover

## Ausführungen

<b>Gestell:</b>	Holzkonstruktion
<b>FüÙe:</b>	Kufen 6cm, Buche Schwarz (Sitzhöhe 43cm)
<b>Aufpreis:</b>	Kufen 10cm, Buche Schwarz (Sitzhöhe 47cm)
<b>Polsterung:</b>	
<b>Sitz:</b>	Taschenfederkern und Polymousse
<b>Arm-, Rückenlehne:</b>	Polymousse mit Vliesabdeckung
<b>Sitzkissen:</b>	Polymousse Sandwichaufbau mit Vliesabdeckung
<b>Sitzkissen soft:</b> (Aufpreis)	Feder Vliesmatte mit Kaltschaumkern
<b>Bezug:</b>	
<b>Korpus:</b>	Fixbezug
<b>Sitzkissen:</b>	Wie Korpus, Bezug abnehmbar

# CAMIN REVISITED Recreation Paolo Piva

29445(R)/ 29411(L)

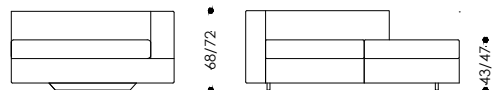

• 140 •      • 183 •

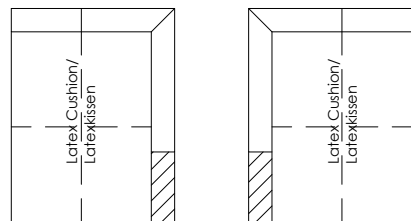

R

L

29450

29451

29452

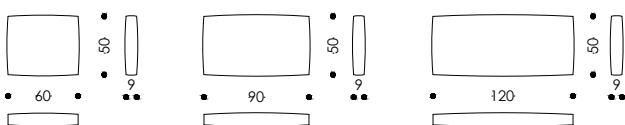

For element groups please attach a drawing to the order/ Bei einer Gruppenbestellung ist unbedingt eine Skizze beizufügen

Back cushions not included/ Lehnkissen nicht im Lieferumfang enthalten

Depending on fabric-, leather requirement, the partition seams of seat and backrest are different/ Je nach Stoff- und Lederbedarf sind die Teilungsnähte in Sitz und Lehnkissen unterschiedlich

	29445/ 29411	29450	29451	29452
Seat width in cm: <i>Sitzbreite in cm:</i>	120	-	-	-
Seat width in inches: <i>Sitzbreite in inches:</i>	47,24	-	-	-
Seat depth in cm: <i>Sitztiefe in cm:</i>	163	-	-	-
Seat depth in inches: <i>Sitztiefe in inches:</i>	64,17	-	-	-
WxDxH(SH) in inches:	55,12x72,05x26,77(16,93)	23,92x3,54x19,69	35,43x3,54x19,69	47,24x3,54x19,69

## Configurations

<b>Frame:</b>	Wooden construction
<b>Feet:</b>	Skids 6cm, Beech Black (Seat height 43cm)
<b>Surcharge:</b>	Skids 10cm, Beech Black (Seat height 47cm)
<b>Upholstery:</b>	
<b>Seat:</b>	Pocket springs and polyurethane foams
<b>Arm-, Backrest:</b>	Polyurethane foams with dacron overlay
<b>Seat cushion soft: (Surcharge)</b>	Feather-dacron cushion with cold foam core
<b>Seat cushion: (29411)</b>	Latex cushion
<b>Back cushion:</b>	Polyurethane feather cushion
<b>Cover:</b>	
<b>Corpus:</b>	Fixed cover
<b>Seat cushion:</b>	Same as corpus, removable cover
<b>Back cushion:</b>	Removeable cover

## Ausführungen

<b>Gestell:</b>	Holzkonstruktion
<b>Füße:</b>	Kufen 6cm, Buche Schwarz (Sitzhöhe 43cm)
<b>Aufpreis:</b>	Kufen 10cm, Buche Schwarz (Sitzhöhe 47cm)
<b>Polsterung:</b>	
<b>Sitz:</b>	Taschenfederkern und Polymousse
<b>Arm-, Rückenlehne:</b>	Polymousse mit Vliesabdeckung
<b>Sitzkissen soft: (Aufpreis)</b>	Feder Vliesmatte mit Kaltschaumkern
<b>Sitzkissen: (29411)</b>	Latexkissen
<b>Lehnkissen:</b>	Polymousse- Federnkissen
<b>Bezug:</b>	
<b>Korpus:</b>	Fixbezug
<b>Sitzkissen:</b>	Wie Korpus, Bezug abnehmbar
<b>Lehnkissen:</b>	Bezug abnehmbar



# CAMIN REVISITED

Recreation Paolo Piva

29418

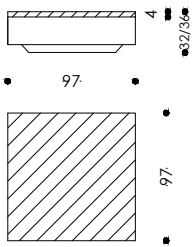

29494

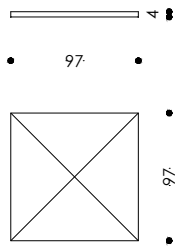

29490

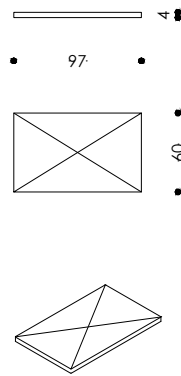

29491

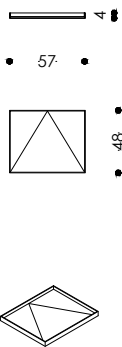

29492

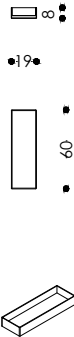

29493

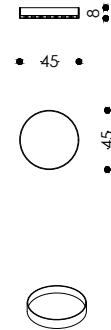

Accessories are recommended on the hatched section of upholstered elements/  
Es wird empfohlen, Accessoires auf dem gestreiften Abschnitt der gepolsterten Elemente zu platzieren

	29418	29494	29490	29491	29492	29493
WxDxH in cm:	97x97x32	97x97x4	97x60x4	57x48x4	19x60x8	Ø45x8
BxTxH in cm:						
WxDxH in inches:	38,19x38,19x12,60	38,19x38,19x1,57	38,19x23,62x1,57	22,44x18,90x1,57	7,48x23,62x3,15	Ø17,72x3,15

## Configurations

<b>Frame:</b>	Wooden construction
<b>Feet:</b>	Skids 6cm, Beech Black (Height 32cm)
<b>Surcharge:</b>	Skids 10cm, Beech Black (Height 36cm)
<b>Cover:</b>	Fixed cover
<b>Storage box:</b>	Leather-covered plastic construction with tray-insert, Oak solid or Walnut solid
<b>Tray insert:</b> (29492,29493)	Oak solid or Walnut solid

## Ausführungen

<b>Gestell:</b>	Holzkonstruktion
<b>FüÙe:</b>	Kufen 6cm, Buche Schwarz (Höhe 43cm)
<b>Aufpreis:</b>	Kufen 10cm, Buche Schwarz (Höhe 47cm)
<b>Bezug:</b>	Fixbezug
<b>Ablagebox:</b>	Lederbezogene Kunststoffkonstruktion mit Tablett-Einsatz, Eiche massiv oder Nuss massiv
<b>Tablett-Einsatz:</b> (29492,29493)	Eiche massiv oder Nuss massiv

# CLUB 1910 Recreation Josef Hoffmann (Design: 1910)

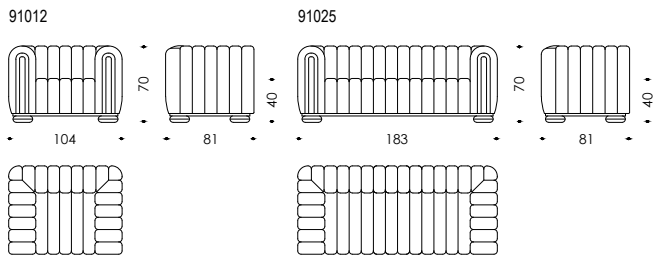

	91012	91025
<b>Seat width in cm:</b> <i>Sitzbreite in cm:</i>	56	135
<b>Seat width in inches:</b> <i>Sitzbreite in inches:</i>	22,05	53,15
<b>Seat depth in cm:</b> <i>Sitztiefe in cm:</i>	53	53
<b>Seat depth in inches:</b> <i>Sitztiefe in inches:</i>	20,87	20,87
<b>WxDxH(SH) in inches:</b>	40,94x31,89x27,56(15,75)	72,05x31,89x27,56(15,75)

## Configurations

<b>Frame:</b>	Wooden construction
<b>Feet:</b>	Black and silver coloured wooden feet with felt glides
<b>Upholstery:</b>	
<b>Seat:</b>	Coil-springs with jute overlay and polyurethane foams sandwich layered with dacron overlay
<b>Arm-, Backrest:</b>	Elastic webbing, Polyurethane foams sandwich layered with dacron overlay
<b>Cover:</b>	Fixed cover with piping
<b>Piping:</b>	Same as cover

## Ausführungen

<b>Gestell:</b>	Holzkonstruktion
<b>FüÙe:</b>	Schwarz und silberfarbene HolzfüÙe mit Filzgleitern
<b>Polsterung:</b>	
<b>Sitz:</b>	Federkern mit Juteabdeckung und Polymousse Sandwichaufbau mit Vliesabdeckung
<b>Arm-, Rückenlehne:</b>	Elastische Begurtung, Polymousse Sandwichaufbau mit Vliesabdeckung
<b>Bezug:</b>	Fixbezug mit Keder
<b>Keder:</b>	Wie Bezug

# COLLI Design: Franz Rendl

2721

Sofa bed with 2x cushions (2702)/  
Schlafsofa mit 2x Kissen (2702)

Sofa bed with 2x cushions (2702) and 2x armrests (2705)/  
Schlafsofa mit 2x Kissen (2702) und 2x Armteilen (2705)

Sofa bed as bed/ Schlafsofa als Bett

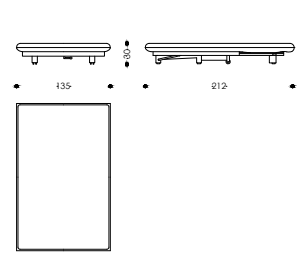
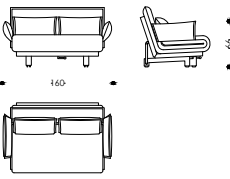
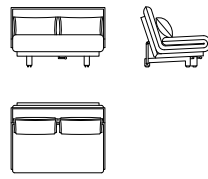
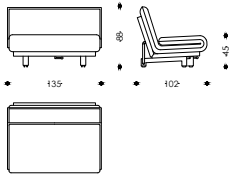

2724

Figure with 3x cushions (2702)/  
Abbildung mit 3x Kissen (2702)

Figure with 3x cushions (2702) and 2x armrests (2705)/  
Abbildung mit 3x Kissen (2702) und 2x Armteilen (2705)

Sofa bed as bed/ Schlafsofa als Bett

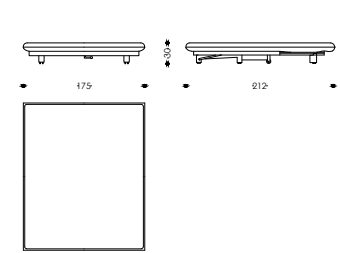
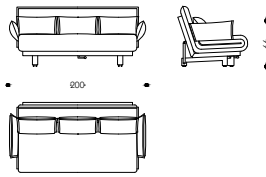
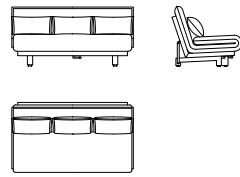
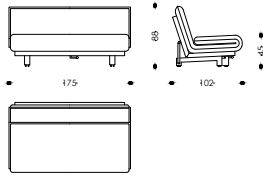

## Armrests not mountable afterwards/ Armteile nachträglich nicht montierbar

	2721	2724
<b>Seat width in cm:</b> <b>Sitzbreite in cm:</b>	135	175
<b>Seat width in inches:</b> <b>Sitzbreite in inches:</b>	51,18	66,93
<b>Seat depth in cm:</b> <b>Sitztiefe in cm:</b>	54	54
<b>Seat depth in inches:</b> <b>Sitztiefe in inches:</b>	21,26	21,26
<b>WxDxH(SH) in inches:</b>	53,15x39,37x34,65(17,72)	68,90x39,37x34,65(17,72)

### Configurations

<b>Frame:</b>	Metal construction with slat grid, adjustable backrest with 5 positions
<b>Lower Frame:</b>	Metal construction, black
<b>Upholstery:</b>	
<b>Seat:</b>	Coil-springs with jute overlay and polyurethane foams sandwich layered with dacron overlay
<b>Arm-, Backrest:</b>	Elastic webbing, Polyurethane foams sandwich layered with dacron overlay
<b>Cover (Mattress):</b>	Fixed cover with flat piping
<b>Surcharge:</b>	Removable cover (fabric only)
<b>Cover: (Cushion, Armrest)</b>	Removable cover
<b>Flat Piping:</b>	Same as cover

### Ausführungen

<b>Gestell:</b>	Metallkonstruktion mit Lattenrost, Rückenlehne 5-fach verstellbar
<b>Untergestell:</b>	Metallkonstruktion, Schwarz
<b>Polsterung:</b>	
<b>Sitz:</b>	Federkern mit Juteabdeckung und Polymousse Sandwichaufbau mit Vliesabdeckung
<b>Arm-, Rückenlehne:</b>	Elastische Begurtung, Polymousse Sandwichaufbau mit Vliesabdeckung
<b>Bezug (Matratze):</b>	Fixbezug mit Biese
<b>Aufpreis:</b>	Bezug abnehmbar (nur Stoff)
<b>Bezug: (Kissen, Armteil):</b>	Bezug abnehmbar
<b>Biese:</b>	Wie Bezug

# CONSTANZE 3/4 Design: Johannes Spalt

1112

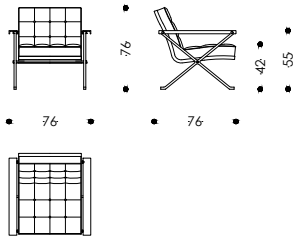

1117

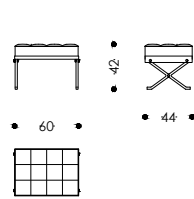

1130

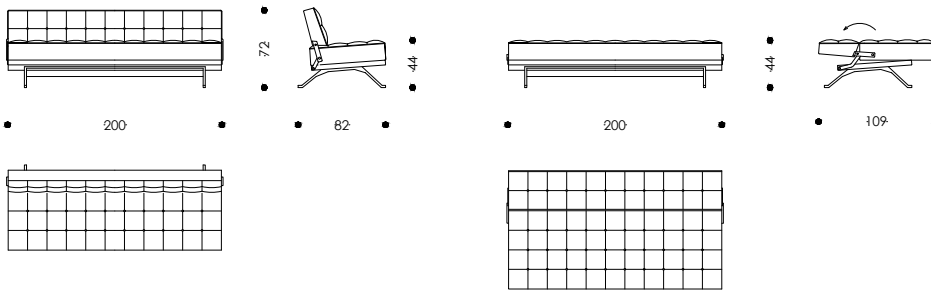

	1112	1117	1130
Seat width in cm: <i>Sitzbreite in cm:</i>	58	60	175
Seat width in inches: <i>Sitzbreite in inches:</i>	22,83	23,62	66,93
Seat depth in cm: <i>Sitztiefe in cm:</i>	48	44	54
Seat depth in inches: <i>Sitztiefe in inches:</i>	18,90	17,32	21,26
WxDxH(SH) in inches:	29,92x29,92x29,92(16,54)	23,62x17,32x15,75	78,84x32,28x28,35(17,32)

## Configurations

<b>Frame:</b>	Metal- wooden construction
<b>Legs:</b>	Chrome
<b>Surcharge:</b>	Black Chrome
<b>Upholstery:</b>	
Shell, Armrests:	Polyurethane foams with dacron overlay
Seat, Backrest:	Polyurethane foams sandwich layered with dacron overlay
<b>Cover:</b>	Fixed cover with button-tacking and piping
<b>Piping:</b>	Same as cover

## Ausführungen

<b>Gestell:</b>	<i>Metall- Holzkonstruktion</i>
<b>Beine:</b>	<i>Chrom</i>
<b>Aufpreis:</b>	<i>Schwarzchrom</i>
<b>Polsterung:</b>	
Schale, Armteile:	<i>Polymousse mit Vliesabdeckung</i>
Sitz, Rückenlehne:	<i>Polymousse Sandwichaufbau mit Vliesabdeckung</i>
<b>Bezug:</b>	<i>Fixbezug mit Knopfleftung und Keder</i>
<b>Keder:</b>	<i>Wie Bezug</i>

# CONTESSA 1956 Design: Wittmann Workshop

26512

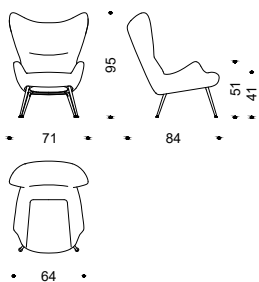

26517

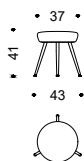

	26512	26517
<b>Seat width in cm:</b> <i>Sitzbreite in cm:</i>	42	37
<b>Seat width in inches:</b> <i>Sitzbreite in inches:</i>	16,54	14,57
<b>Seat depth in cm:</b> <i>Sitztiefe in cm:</i>	49	37
<b>Seat depth in inches:</b> <i>Sitztiefe in inches:</i>	19,29	14,57
<b>WxDxH(SH) in inches:</b>	27,95x33,07x37,40(16,14)	16,93x16,93x16,14

## Configurations

### Frame:

Armchair: Metal construction  
 Stool: Wooden construction  
 Legs: Metal, Black Grey with Chrome glides

### Upholstery:

Seat (Armchair): Fixed webbing, high-resilient polyurethane foams with pocket springs and dacron overlay  
 Seat (Stool): Polyurethane foams sandwich layered with dacron overlay  
 Arm-, Backrest: High-resilient polyurethane foams with dacron overlay  
 Cover: Fixed cover with piping  
 Piping: Same as cover  
 Without surcharge: Leather in standard colours Color Atlantic, Black, Cognac, Dark grey, Mocca, Sand, Siena and Taupe

## Ausführungen

### Gestell:

Fauteuil: Metallkonstruktion  
 Hocker: Holzkonstruktion  
 Beine: Metall, Black Grey mit Chromgleitern

### Polsterung:

Sitz (Fauteuil): Starre Begurtung, hoch belastbarer Polyurethan Schaumstoff mit Taschenfederkern und Vliesabdeckung  
 Sitz (Hocker): Polymousse Sandwichaufbau mit Vliesabdeckung  
 Arm-, Rückenlehne: Hoch belastbarer Polyurethan Schaumstoff mit Vliesabdeckung  
 Bezug: Fixbezug mit Keder  
 Keder: Wie Bezug  
 Auf Wunsch: Leder in Standardfarben Color Atlantic, Black, Cognac, Dark grey, Mocca, Sand, Siena und Taupe

# FAME Design: Christophe Pillet

22312

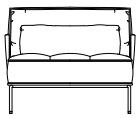

76

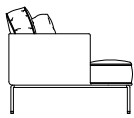

38

58

92

58

92

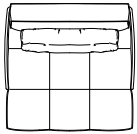

22317

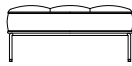

38

90



60



	22312	22317
<b>Seat width in cm:</b> <i>Sitzbreite in cm:</i>	90	90
<b>Seat width in inches:</b> <i>Sitzbreite in inches:</i>	35,43	35,43
<b>Seat depth in cm:</b> <i>Sitztiefe in cm:</i>	53	60
<b>Seat depth in inches:</b> <i>Sitztiefe in inches:</i>	20,87	23,62
<b>WxDxH(SH) in inches:</b>	36,22x36,22x29,92(14,96)	35,43x23,62x14,96

## Configurations

<b>Frame:</b>	Metal- wooden construction
<b>Lower frame:</b>	Metal Black Grey with leather fiber glides
<b>Surcharge:</b>	Brass Satin Matt or Metal Traffic White
<b>Upholstery:</b>	
<b>Seat:</b>	Loose seat cushion with pocket springs and polyurethane foams sandwich layered with dacron overlay
<b>Shell:</b>	Polyurethane foams with dacron overlay
<b>Cushion large:</b>	100% feather filling with polyurethane core
<b>Cushion small:</b>	100% feather filling
<b>Cover:</b>	Fixed cover with stitched seam, concealed-tacking
<b>unicolour:</b>	Shell/ Base frame same as seat
<b>multicolour:</b>	Shell/ Base frame in different colour

## Ausführungen

<b>Gestell:</b>	Metal- Holzkonstruktion
<b>Untergestell:</b>	Metal Black Grey mit Lederfasergleitern
<b>Aufpreis:</b>	Messing Satin Matt oder Metall Verkehrsweiß
<b>Polsterung:</b>	
<b>Sitz:</b>	Loses Sitzkissen mit Taschenfederkern und Polymousse Sandwichaufbau mit Vliesabdeckung
<b>Schale:</b>	Polymousse mit Vliesabdeckung
<b>Kissen groß:</b>	100% Federfüllung mit Polymousse Kern
<b>Kissen klein:</b>	100% Federfüllung
<b>Bezug:</b>	Fixbezug mit Steppnaht, Blindheftung
<b>einfärbig:</b>	Schale/ Basisrahmen wie Sitz
<b>mehrfärbig:</b>	Schale/ Basisrahmen andersfärbig

# FIGURE Design: Luca Nichetto

27612

27620

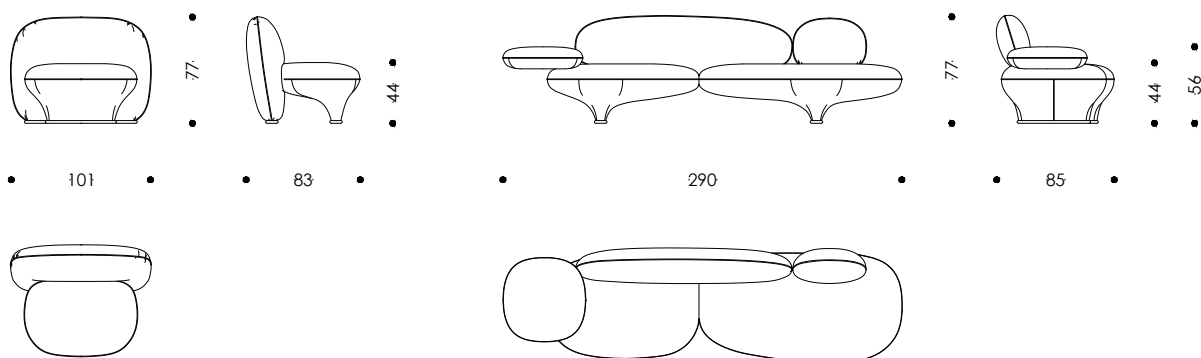

**For Salone 23 Edition, the delivery time has to be requested prior to order placement/  
Für Salone 23 Edition ist die Lieferzeit vor Auftrag anzufagen**

	27612	27620
<b>Seat width in cm:</b> <i>Sitzbreite in cm:</i>	80	90
<b>Seat width in inches:</b> <i>Sitzbreite in inches:</i>	31,50	35,43
<b>Seat depth in cm:</b> <i>Sitztiefe in cm:</i>	55	60
<b>Seat depth in inches:</b> <i>Sitztiefe in inches:</i>	21,65	23,62
<b>WxDxH(SH) in inches:</b>	39,76x32,68x30,31(17,32)	114,17x33,46x30,31(17,32)

## Configurations

<b>Frame:</b>	Metal- wooden construction
<b>Feet:</b>	Beech solid Black with felt glides
<b>Upholstery:</b>	
<b>Seat:</b>	Fixed webbing with pocket springs and polyurethane foams sandwich layered with dacron overlay
<b>Arm-, Backrest:</b>	Polyurethane foams sandwich layered with dacron overlay
<b>Cover:</b>	Fixed cover with piping in fabric
<b>unicolour:</b>	All elements in same colour
<b>multicolour:</b>	Elements in different colours Sofa: Max. 5 colours Lounge Chair: Max. 2 colours
<b>Salone 23 Edition:</b>	Fixed cover in sheepskin leather, unicolour
<b>Piping:</b>	Same as cover

## Ausführungen

<b>Gestell:</b>	Metall- Holzkonstruktion
<b>FüÙe:</b>	Buche massiv Schwarz mit Filzgleitern
<b>Polsterung:</b>	
<b>Sitz:</b>	Starre Begurtung mit Taschenfederkern und Polymousse Sandwichaufbau mit Vliesabdeckung
<b>Arm-, Rückenlehne:</b>	Polymousse Sandwichaufbau mit Vliesabdeckung
<b>Bezug:</b>	Fixbezug mit Keder in Stoff
<b>einfärbig:</b>	Alle Elemente gleichfärbig
<b>mehrfärbig:</b>	Elemente andersfärbig Sofa: Max. 5 Farben Fauteuil: Max. 2 Farben
<b>Salone 23 Edition:</b>	Fixbezug in Lammfell, einfärbig
<b>Keder:</b>	Wie Bezug

# FREISCHWINGER NR.2 Re-Edition Friedrich Kiesler\* (Design: 1936)

17363

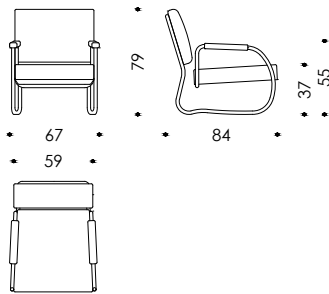

After a signed sketch by Friedrich Kiesler for the apartment Charles and Marguerite Mergentime, New York, around 1933  
 Nach einer signierten Zeichnung von Friedrich Kiesler für die Wohnung Charles und Marguerite Mergentime, New York, um 1933

	<b>17363</b>
<b>Seat width in cm:</b> <i>Sitzbreite in cm:</i>	54
<b>Seat width in inches:</b> <i>Sitzbreite in inches:</i>	21,26
<b>Seat depth in cm:</b> <i>Sitztiefe in cm:</i>	58
<b>Seat depth in inches:</b> <i>Sitztiefe in inches:</i>	24,21
<b>WxDxH(SH) in inches:</b>	23,23x33,86x31,10(14,57)

## Configurations

<b>Frame:</b>	Metal- wooden construction
<b>Lower frame:</b>	Metal Chrome
<b>Upholstery:</b>	
<b>Seat:</b>	Elastic webbing, polyurethane foams sandwich layered with pocket springs and dacron overlay
<b>Backrest:</b>	Polyurethane foams sandwich layered with dacron overlay
<b>Armrest:</b>	Wood core covered with polyurethane foams
<b>Cover:</b>	Fixed cover

## Ausführungen

<b>Gestell:</b>	Metall- Holzkonstruktion
<b>Untergestell:</b>	Metall Chrom
<b>Polsterung:</b>	
<b>Sitz:</b>	Elastische Begurtung, Polymousse Sandwichaufbau mit Taschenfederkern und Vliesabdeckung
<b>Rückenlehne:</b>	Polymousse Sandwichaufbau mit Vliesabdeckung
<b>Armlehne:</b>	Holzern mit Schaumstoffummantelung
<b>Bezug:</b>	Fixbezug



# HAUS KOLLER Recreation Josef Hoffmann (Design: 1914)

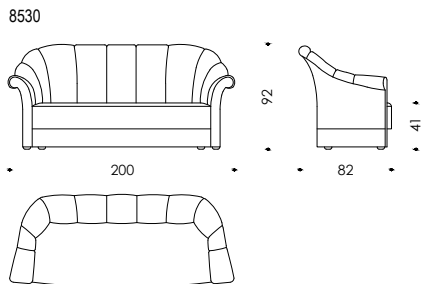
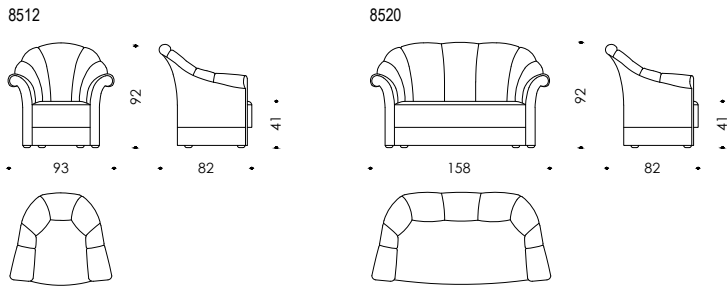

Please note that this product will be individually produced and the delivery time has to be requested/  
Bitte beachten Sie, dass dieses Modell in Einzelanfertigung hergestellt wird, daher ist die Lieferzeit vor Auftrag anzufagen

	8512	8520	8530
Seat width in cm: Sitzbreite in cm:	50	110	152
Seat width in inches: Sitzbreite in inches:	19,69	43,31	59,84
Seat depth in cm: Sitztiefe in cm:	53	53	53
Seat depth in inches: Sitztiefe in inches:	20,87	20,87	20,87
WxDxH(SH) in inches:	36,61x32,28x36,22(16,14)	62,20x32,28x36,22(16,14)	78,74x32,28x36,22(16,14)

## Configurations

<b>Frame:</b>	Wooden construction
<b>Legs:</b>	Beech solid Black with metal glides
<b>Upholstery:</b>	
<b>Seat:</b>	Elastic webbing, Polyurethane foams and Latex sandwich layered with dacron overlay
<b>Arm-/Backrest:</b>	Elastic webbing, polyurethane foams sandwich layered with dacron overlay
<b>Cover:</b>	Fixed cover with piping or braid
<b>Piping:</b>	Same as cover
<b>Without surcharge:</b>	Leather in standard colours Color Atlantic, Black, Cognac, Dark grey, Mocca, Sand, Siena and Taupe
<b>Braid:</b>	Black
<b>Without surcharge:</b>	Black&White
<b>Surcharge:</b>	Matching the fabric (single-/ two-tone)

## Ausführungen

<b>Gestell:</b>	Holzkonstruktion
<b>Beine:</b>	Buche massiv Schwarz mit Metallgleitern
<b>Polsterung:</b>	
<b>Sitz:</b>	Elastische Begurtung, Polymousse und Latex Sandwichaufbau mit Vliesabdeckung
<b>Arm-/Rückenlehne:</b>	Elastische Begurtung, Polymousse Sandwichaufbau mit Vliesabdeckung
<b>Bezug:</b>	Fixbezug mit Keder oder Borte
<b>Keder:</b>	wie Bezug
<b>Auf Wunsch:</b>	Leder in Standardfarben Color Atlantic, Black, Cognac, Dark grey, Mocca, Sand, Siena und Taupe
<b>Borte:</b>	Schwarz
<b>Auf Wunsch:</b>	Schwarz&Weiß
<b>Aufpreis:</b>	passend zum Stoff (ein-/ zweifärbig)

<b>Cover in Streif 4:</b>	Fixed cover with piping or braid
<b>Piping:</b>	Streif 4 fabric uni-black or uni-white without surcharge
<b>Braid:</b>	Black or Black&White without surcharge

<b>Bezug in Streif 4:</b>	Fixbezug mit Keder oder Borte
<b>Keder:</b>	Streif 4 Stoff Uni-Schwarz oder Uni-Weiß auf Wunsch
<b>Borte:</b>	Schwarz oder Schwarz&Weiß auf Wunsch

# HAVANNA

Design: Paolo Piva

6620

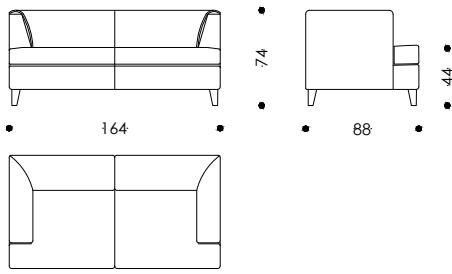

6625

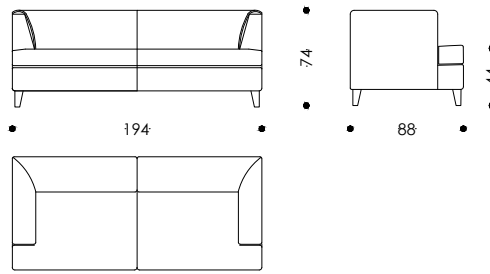

6630

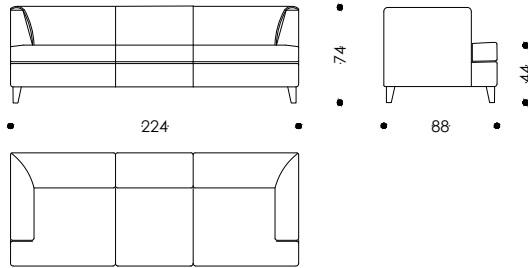

The Polyurethane fleece mat is divided into chambers filled with a combination of polyurethane foam pieces and selected feathers. The seat surface may reflect these chambers in use. Please fluff up the seat regularly to ensure material reconditioning./  
Die Polymoussevliesmatte ist in Kammern unterteilt, die mit einer Kombination aus Polyurethanschaumteilen und ausgewählten Federn gefüllt sind. Im Gebrauch wird die Sitzoberfläche lebendig. Bitte lockern Sie den Sitz regelmäßig auf, um eine Rückstellung der Materialien zu gewährleisten.

	6620	6625	6630
Seat width in cm: <i>Sitzbreite in cm:</i>	122	152	182
Seat width in inches: <i>Sitzbreite in inches:</i>	48,03	59,84	17,65
Seat depth in cm: <i>Sitztiefe in cm:</i>	57	57	57
Seat depth in inches: <i>Sitztiefe in inches:</i>	22,44	22,44	22,44
<b>WxDxH(SH) in inches:</b>	64,57x34,65x29,13(17,32)	76,38x34,65x29,13(17,32)	88,19x34,65x29,13(17,32)

## Configurations

<b>Frame:</b>	Wooden construction
<b>Feet:</b>	Buche massiv Schwarz mit Filzgleitern
<b>Surcharge:</b>	In Wittmann standard RAL colours
<b>Upholstery:</b>	
<b>Corpus:</b>	Elastic webbing, polyurethane foams with dacron overlay
<b>Seat:</b>	Polyurethane foams, stitched polyurethane fleece mat, dacron overlay
<b>Arm-, Backrest:</b>	Elastic webbing, polyurethane foams sandwich layered with dacron overlay
<b>Cover:</b>	Fixed cover with piping

## Ausführungen

<b>Gestell:</b>	Holzkonstruktion
<b>Füße:</b>	Beech solid Black with felt glides
<b>Aufpreis:</b>	In Wittmann Standard RAL Farben
<b>Polsterung:</b>	
<b>Korpus:</b>	Elastische Begurtung, Polymousse mit Vliesabdeckung
<b>Sitz:</b>	Polymousse, gesteppte Polymoussevliesmatte, Vliesabdeckung
<b>Arm-, Rückenlehne:</b>	Elastische Begurtung, Polymousse Sandwichaufbau mit Vliesabdeckung
<b>Bezug:</b>	Fixbezug mit Keder

# JOLLY Design: Jan Armgardt

18818

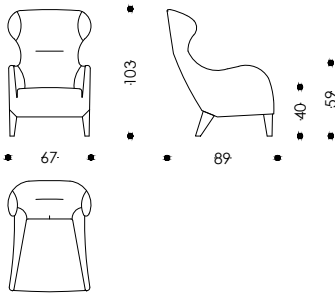

18817

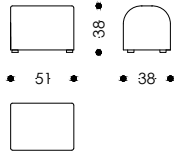

18816

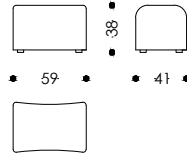

18801

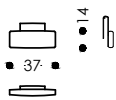

18802

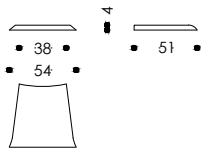

	18818	18816	18817
<b>Seat width in cm:</b> <i>Sitzbreite in cm:</i>	51	59	51
<b>Seat width in inches:</b> <i>Sitzbreite in inches:</i>	20,08	23,23	20,08
<b>Seat depth in cm:</b> <i>Sitztiefe in cm:</i>	51	41	39
<b>Seat depth in inches:</b> <i>Sitztiefe in inches:</i>	20,08	16,14	15,35
<b>WxDxH(SH) in inches:</b>	26,38x33,46x40,16(15,75)	23,23x16,14x14,96	20,08x14,96x14,96

## Configurations

<b>Frame:</b>	Wooden construction
<b>Legs:</b> <b>(Highback Chair)</b>	Beech solid Black with felt glides
<b>Surcharge:</b>	In Wittmann standard RAL colours
<b>Legs (Stool):</b>	Black plastic
<b>Upholstery:</b>	
<b>Seat:</b> <b>(Highback Chair)</b>	Elastic webbing, polyurethane foams sandwich layered with dacron overlay
<b>Arm-, Backrest:</b> <b>(Highback Chair)</b>	polyurethane foams with dacron overlay
<b>Stool:</b>	Polyurethane foams sandwich layered with dacron overlay
<b>Cover:</b>	Fixed cover

## Ausführungen

<b>Gestell:</b>	Holzkonstruktion
<b>Beine:</b> <b>(Hochlehner)</b>	Buche massiv Schwarz mit Filzgleitern
<b>Aufpreis:</b>	In Wittmann Standard RAL Farben
<b>Beine (Hocker):</b>	Kunststoff Schwarz
<b>Polsterung:</b>	
<b>Sitz:</b> <b>(Hochlehner)</b>	Elastische Begurtung, Polymousse Sandwichaufbau mit Vliesabdeckung
<b>Arm-, Rückenlehne:</b> <b>(Hochlehner)</b>	Polymousse mit Vliesabdeckung
<b>Hocker:</b>	Polymousse Sandwichaufbau mit Vliesabdeckung
<b>Bezug:</b>	Fixbezug

# JOLLY Design: Jan Armgardt

18815

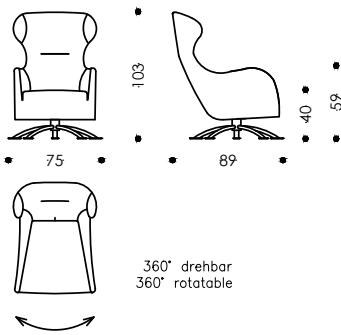

18819

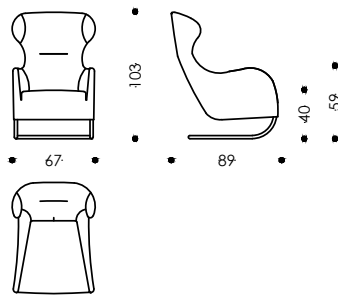

18813

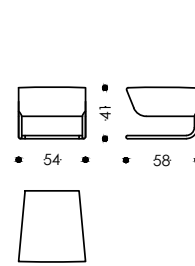

18801

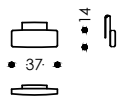

18802

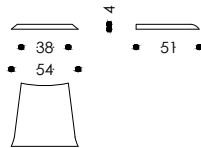

	18815	18819	18813
<b>Seat width in cm:</b> <i>Sitzbreite in cm:</i>	51	51	54
<b>Seat width in inches:</b> <i>Sitzbreite in inches:</i>	20,08	20,08	21,26
<b>Seat depth in cm:</b> <i>Sitztiefe in cm:</i>	51	51	58
<b>Seat depth in inches:</b> <i>Sitztiefe in inches:</i>	20,08	20,08	22,83
<b>WxDxH(SH) in inches:</b>	26,38x33,46x40,16(15,75)	26,38x33,46x40,16(15,75)	21,26x22,83x16,14

## Configurations

<b>Frame:</b>	Metal- wooden construction
<b>Legs:</b>	Chrome with plastic glides
<b>Surcharge:</b>	Metal Black Grey
<b>Upholstery:</b>	
<b>Seat:</b> (Highback Chair)	Elastic webbing, polyurethane foams sandwich layered with dacron overlay
<b>Arm-, Backrest:</b> (Highback Chair)	polyurethane foams with dacron overlay
<b>Stool:</b>	Elastic webbing, polyurethane foams sandwich layered with dacron overlay
<b>Cover:</b>	Fixed cover

## Ausführungen

<b>Gestell:</b>	Metall- Holzkonstruktion
<b>Beine:</b>	Chrom mit Kunststoffgleitern
<b>Aufpreis:</b>	Metall Black Grey
<b>Polsterung:</b>	
<b>Sitz:</b> (Hochlehner)	Elastische Begurtung, Polymousse Sandwichaufbau mit Vliesabdeckung
<b>Arm-, Rückenlehne:</b> (Hochlehner)	Polymousse mit Vliesabdeckung
<b>Hocker:</b>	Elastische Begurtung, Polymousse Sandwichaufbau mit Vliesabdeckung
<b>Bezug:</b>	Fixbezug

# JOLLY ,ALL IN ONE' Design: Jan Armgardt

19819

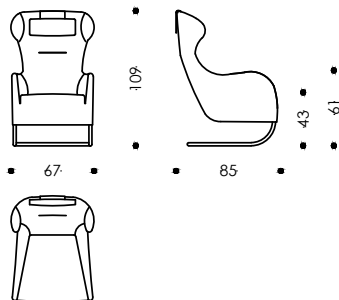

19819	
Seat width in cm: <i>Sitzbreite in cm:</i>	51
Seat width in inches: <i>Sitzbreite in inches:</i>	20,08
Seat depth in cm: <i>Sitztiefe in cm:</i>	51
Seat depth in inches: <i>Sitztiefe in inches:</i>	20,08
<b>WxDxH(SH) in inches:</b>	26,38x33,46x42,91(16,93)

## Configurations

<b>Frame:</b>	Metal- wooden construction
<b>Legs:</b>	Chrome with plastic glides
<b>Surcharge:</b>	Metal Black Grey
<b>Upholstery:</b>	
<b>Seat:</b>	Elastic webbing, polyurethane foams sandwich layered with dacron overlay
<b>Arm-, Backrest:</b>	polyurethane foams with dacron overlay
<b>Cover:</b>	Fixed cover

## Ausführungen

<b>Gestell:</b>	<i>Metall- Holzkonstruktion</i>
<b>Beine:</b>	<i>Chrom mit Kunststoffgleitern</i>
<b>Aufpreis:</b>	<i>Metall Black Grey</i>
<b>Polsterung:</b>	
<b>Sitz:</b>	<i>Elastische Begurtung, Polymousse Sandwichaufbau mit Vliesabdeckung</i>
<b>Arm-, Rückenlehne:</b>	<i>Polymousse mit Vliesabdeckung</i>
<b>Bezug:</b>	<i>Fixbezug</i>

# KUBUS Recreation Josef Hoffmann (Design: 1910)

8012

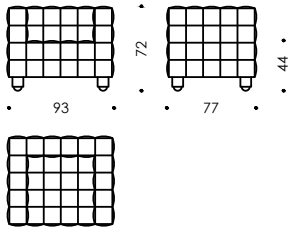

8020

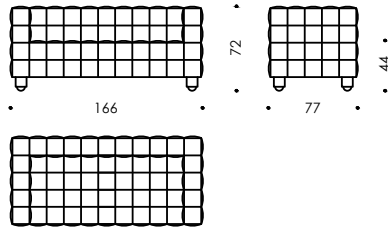

8030

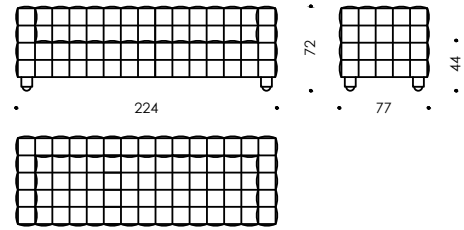

	8012	8020	8030
Seat width in cm: <i>Sitzbreite in cm:</i>	55	127	185
Seat width in inches: <i>Sitzbreite in inches:</i>	21,65	50,00	72,83
Seat depth in cm: <i>Sitztiefe in cm:</i>	57	57	57
Seat depth in inches: <i>Sitztiefe in inches:</i>	22,44	22,44	22,44
WxDxH(SH) in inches:	36,61x30,32x28,35(17,32)	65,35x30,32x28,35(17,32)	88,19x30,32x28,35(17,32)

## Configurations

<b>Frame:</b>	Wooden construction
<b>Legs:</b>	Beech solid Black with silver coloured foot base and metal glides
<b>Upholstery:</b>	
<b>Seat:</b>	Linear wave springs with jute overlay and polyurethane foams sandwich layered
<b>Backrest:</b>	Elastic webbing, polyurethane foams sandwich layered
<b>Armrest:</b>	polyurethane foams sandwich layered
<b>Cover:</b>	Fixed cover in leather with piping

## Ausführungen

<b>Gestell:</b>	Holzkonstruktion
<b>Beine:</b>	Buche massiv Schwarz mit silberfarbenen Fußabschluss und Metallgleitern
<b>Polsterung:</b>	
<b>Sitz:</b>	Wellenfederung mit Juteabdeckung und Polymousse Sandwichaufbau
<b>Rückenlehne:</b>	Elastische Begurtung, Polymousse Sandwichaufbau
<b>Armlehne:</b>	Polymousse Sandwichaufbau
<b>Bezug:</b>	Fixbezug in Leder mit Keder

# LILIAN Design: Wittmann Workshop

28512

28513

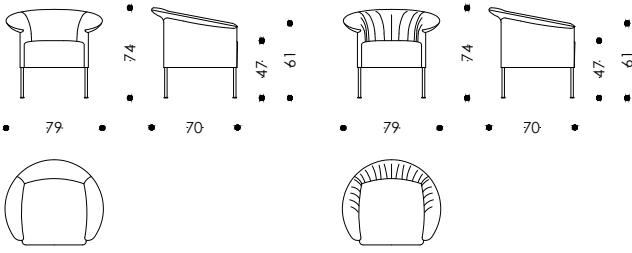

	28512	28513
<b>Seat width in cm:</b> <i>Sitzbreite in cm:</i>	49	49
<b>Seat width in inches:</b> <i>Sitzbreite in inches:</i>	19,29	19,29
<b>Seat depth in cm:</b> <i>Sitztiefe in cm:</i>	27	27
<b>Seat depth in inches:</b> <i>Sitztiefe in inches:</i>	18,50	18,50
<b>WxDxH(SH) in inches:</b>	31,10x27,56x29,13(18,50)	31,10x27,56x29,13(18,50)

## Configurations

<b>Frame:</b>	Metal construction
<b>Legs:</b>	Metal Black Grey with Teflon glides
<b>Foot Base:</b>	Metal Black Grey with Teflon glides
<b>Surcharge:</b>	Brass Satin Matt
<b>Seat height:</b>	47cm
<b>Without surcharge:</b>	51cm
<b>Upholstery:</b>	
<b>Seat:</b>	Coil springs, polyurethane foams sandwich layered with dacron overlay
<b>Shell:</b>	high-resilient polyurethane foams with linear springs and dacron overlay
<b>Cover:</b>	Fixed cover
<b>unicolour:</b>	Seat, shell inside and outside in same colour
<b>multicolour:</b>	Shell outside in different colour

## Ausführungen

<b>Gestell:</b>	Metallkonstruktion
<b>Beine:</b>	Metall Black Grey mit Teflongleitern
<b>Fußabschluss:</b>	Metall Black Grey mit Teflongleitern
<b>Aufpreis:</b>	Messing Satin Matt
<b>Sitzhöhe:</b>	47cm
<b>Auf Wunsch:</b>	51cm
<b>Polsterung:</b>	
<b>Sitz:</b>	Federkern, Polymousse Sandwichaufbau mit Vliesabdeckung
<b>Schale:</b>	Hoch belastbarer Polyurethan Schaumstoff mit Wellenfeder und Vliesabdeckung
<b>Bezug:</b>	Fixbezug
<b>einfärbig:</b>	Sitz, Schale innen und außen gleichfärbig
<b>mehrfärbig:</b>	Schale außen andersfärbig

# MATERASSI Design: Matteo Thun

## Combination Examples/ *Kombinationsbeispiele*

Combination Example 1/ *Kombinationsbeispiel 1*

1x Element 202/ *Element 202* (5911)  
1x Armrest 75/ *Armlehne 75* (5906)

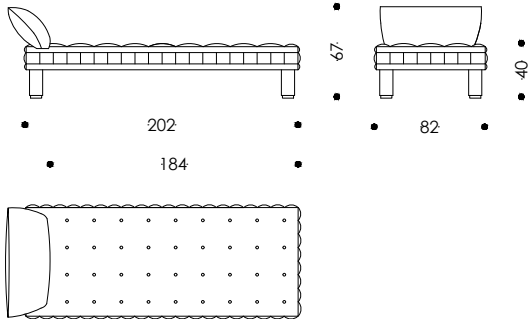

Combination Example 2/ *Kombinationsbeispiel 2*

1x Element 202 deep/ *Element 202 tief* (5919)  
1x Backrest 100/ *Rückenlehne 100* (5903)  
1x Backrest 80/ *Rückenlehne 80* (5902)

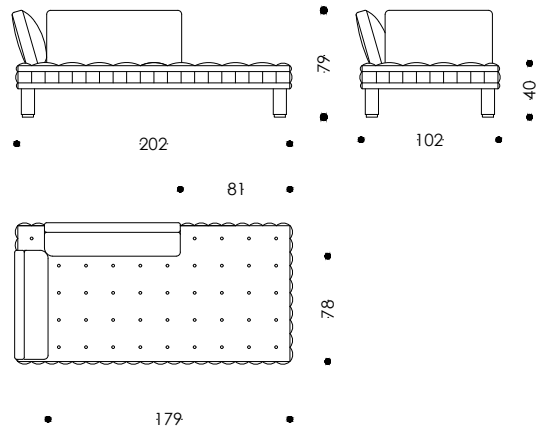

Combination Example 3/ *Kombinationsbeispiel 3*

1x Element 202/ *Element 202* (5911)  
2x Backrest 100/ *Rückenlehne 100* (5903)  
2x Armrest 55/ *Armlehne 55* (5905)

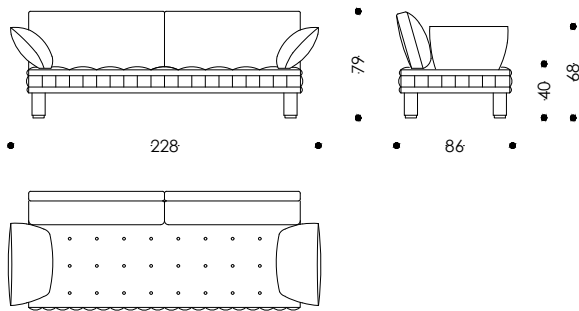

Combination Example 4/ *Kombinationsbeispiel 4*

1x Element 202 deep/ *Element 202 tief* (5919)  
2x Backrest 100/ *Backrest 100* (5903)  
1x Armrest 75/ *Armlehne 75* (5906)  
1x Armrest 55/ *Armlehne 55* (5905)

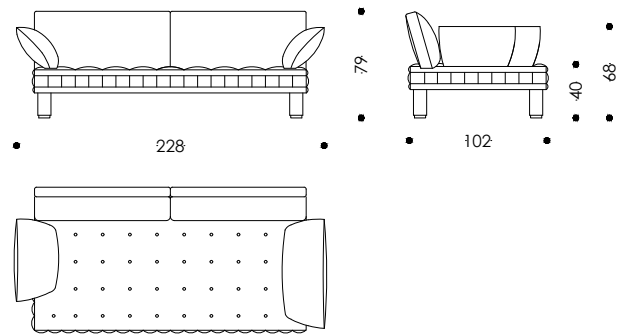

Combination Example 5/ *Kombinationsbeispiel 5*

1x Element 82/ *Element 82* (5913)  
2x Backrest 80/ *Rückenlehne 80* (5902)

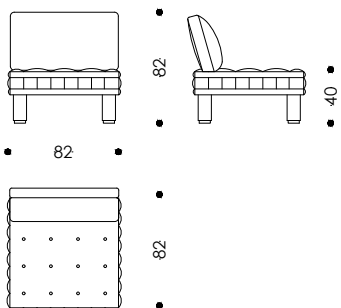



# MATERASSI

Design: Matteo Thun

5913

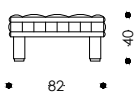

5910

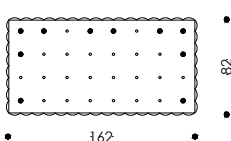
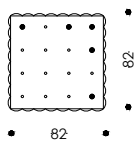
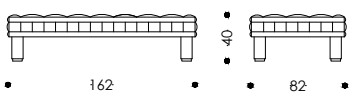

5911

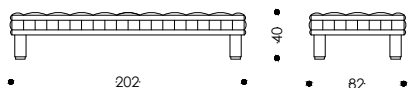

5919

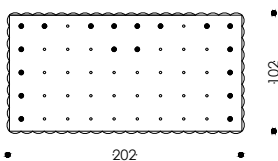
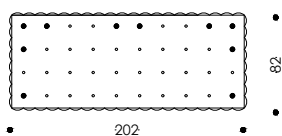
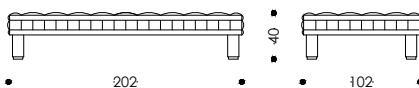

Designated spots serve as fitting positions for arm- and backrest. These will be covered with upholstered buttons when not in use./  
Markierte Stellen dienen als Einsetzpositionen für Arm- und Rückenlehne. Diese werden bei Nichtverwendung mit gepolsterten Knöpfen abgedeckt.

	5913	5910	5911	5919
Seat width in cm: Sitzbreite in cm:	82	162	202	202
Seat width in inches: Sitzbreite in inches:	32,28	63,78	79,53	79,53
Seat depth in cm: Sitztiefe in cm:	82	82	82	102
Seat depth in inches: Sitztiefe in inches:	32,28	32,28	32,28	40,16
WxDxH(SH) in inches:	32,28x32,28x15,75	63,78x32,28x15,75	79,53x32,28x15,75	79,53x40,16x15,75

## Configurations

**Frame:** Wooden construction, insert fittings made of metal and plastic

**Legs:** Lime solid, Black

**Feet:** Chrome-coloured plastic feet

## Upholstery:

**Seat:** Linear wave springs with jute overlay and polyurethane foams sandwich layered with dacron overlay

**Arm-, Backrest:** polyurethane foams sandwich layered with dacron overlay

**Cover:** Fixed cover with quilted sides and piping, tacked with upholstered buttons

**Piping:** Same as cover

**Without surcharge:** Leather in standard colours Color Atlantic, Black, Cognac, Dark grey, Mocca, Sand, Siena and Taupe

**Surcharge:** Different coloured leather

**Buttons:** Same as seat

**Without surcharge:** Same as piping

## Ausführungen

**Gestell:** Holzkonstruktion, Steckbeschläge aus Metall und Kunststoff

**Beine:** Linde massiv, Schwarz

**FüÙe:** Chromfarbene KunststofffüÙe

## Polsterung:

**Sitz:** Wellenfederung mit Juteabdeckung und Polymousse Sandwichaufbau mit Vliesabdeckung

**Arm-, Rückenlehne:** Polymousse Sandwichaufbau mit Vliesabdeckung

**Bezug:** Fixbezug mit gesteppten Seiten und Keder, geheftet mit bezogenen Knöpfen

**Keder:** Wie Bezug

**Auf Wunsch:** Leder in Standardfarben Color Atlantic, Black, Cognac, Dark grey, Mocca, Sand, Siena und Taupe

**Aufpreis:** Andersfarbiges Leder

**Knöpf:** Wie Sitz

**Auf Wunsch:** Wie Keder

# MATERASSI

Design: Matteo Thun

5902

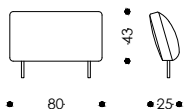

5903

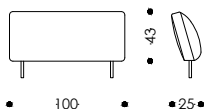

5905

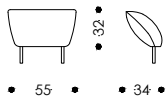

5906

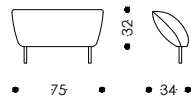

	5902	5903	5905	5906
<b>WxDxH in cm:</b>	80x25x43	100x25x43	58x34x32	78x34x32
<b>BxTxH in cm:</b>				
<b>WxDxH in inches:</b>	31,50x9,84x16,93	39,37x9,84x16,93	22,83x13,39x12,60	30,71x13,39x12,60

## Configurations

<b>Frame:</b>	Metal Chrome
<b>Upholstery:</b>	Polyurethane foams sandwich layered with dacron overlay
<b>Cover:</b>	Fixed cover with piping
<b>Piping:</b>	Same as cover

## Ausführungen

<b>Gestell:</b>	Metall Chrom
<b>Polsterung:</b>	Polymousse Sandwichaufbau mit Vliesabdeckung
<b>Bezug:</b>	Fixbezug mit Keder
<b>Keder:</b>	Wie Bezug

# MERWYN LOUNGE

Design: Sebastian Herkner

29612

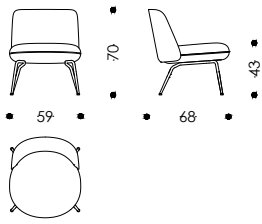

29613

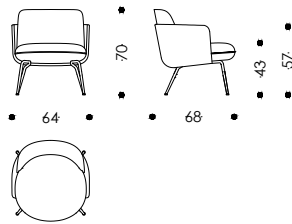

29620

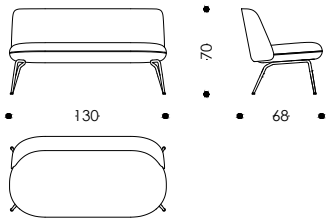

29625

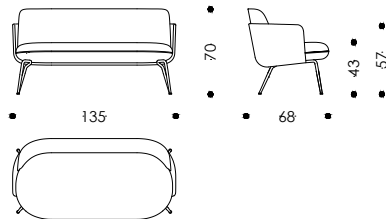

	29612	29613	29620	29625
<b>Seat width in cm:</b> <i>Sitzbreite in cm:</i>	59	59	130	130
<b>Seat width in inches:</b> <i>Sitzbreite in inches:</i>	23,23	23,23	51,18	51,18
<b>Seat depth in cm:</b> <i>Sitztiefe in cm:</i>	53	53	53	53
<b>Seat depth in inches:</b> <i>Sitztiefe in inches:</i>	20,87	20,87	20,87	20,87
<b>WxDxH(SH) in inches:</b>	23,23x26,77x29,53(16,93)	25,20x26,77x29,53(16,93)	51,18x26,77x29,53(16,93)	53,15x29,53x26,77(16,93)

## Configurations

<b>Frame:</b>	Metal- wooden construction
<b>Legs:</b>	Metal Black Grey with Teflon glides
<b>Surcharge:</b>	Brass Satin Matt or Soft Copper
<b>Upholstery:</b>	
<b>Seat:</b>	High-resilient polyurethane foams with pocket springs and dacron overlay
<b>Backrest:</b>	High-resilient polyurethane foams with dacron overlay
<b>Armrest shell:</b> (29613, 29625)	Glass fiber reinforced nylon with dacron overlay
<b>Cover:</b>	
<b>Seat:</b>	Fixed cover with piping
<b>Backrest:</b>	Fixed cover
<b>Armrest shell:</b> (29613, 29625)	Fixed cover in leather
<b>Piping:</b>	Same as cover
<b>Without surcharge:</b>	Leather in standard colours Color Atlantic, Black, Cognac, Dark grey, Mocca, Sand, Siena and Taupe or same as armrest shell (29613, 29625)

## Ausführungen

<b>Gestell:</b>	<i>Metall- Holzkonstruktion</i>
<b>Beine:</b>	<i>Metall Black Grey mit Teflingleitern</i>
<b>Aufpreis:</b>	<i>Messing Satin Matt oder Soft Copper</i>
<b>Polsterung:</b>	
<b>Sitz:</b>	<i>Hoch belastbarer Polyurethan Schaumstoff mit Taschenfederkern und Vliesabdeckung</i>
<b>Rückenlehne:</b>	<i>Hoch belastbarer Polyurethan Schaumstoff mit Vliesabdeckung</i>
<b>Armteilschale:</b> (29613, 29625)	<i>Glasfaserverstärktes Polyamid mit Vliesabdeckung</i>
<b>Bezug:</b>	
<b>Sitz:</b>	<i>Fixbezug mit Keder</i>
<b>Lehne:</b>	<i>Fixbezug</i>
<b>Armteilschale:</b> (29613, 29625)	<i>Fixbezug in Leder</i>
<b>Keder:</b>	<i>Wie Bezug</i>
<b>Auf Wunsch:</b>	<i>Leder in Standardfarben Color Atlantic, Black, Cognac, Dark grey, Mocca, Sand, Siena und Taupe oder wie Armteilschale (29613, 29625)</i>

# MILES LOUNGE

Design: Sebastian Herkner

29512

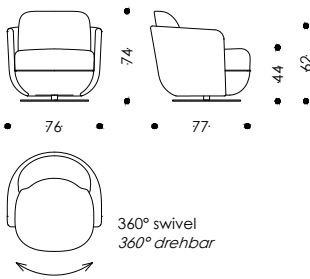

29517

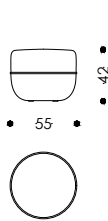

29520

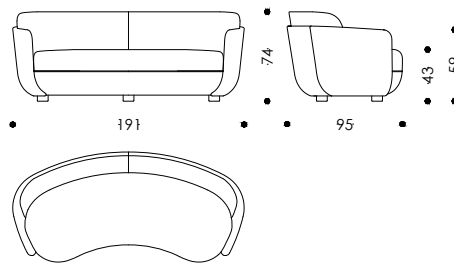

29525

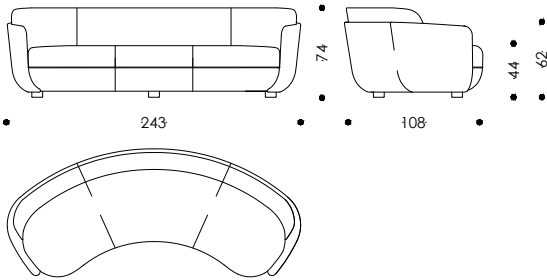

29530

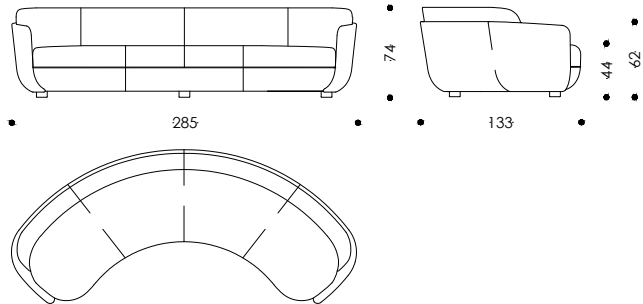

	29512	29517	29520	29525	29530
<b>Seat width in cm:</b> <i>Sitzbreite in cm:</i>	65	55	172	218	257
<b>Seat width in inches:</b> <i>Sitzbreite in inches:</i>	25,59	21,65	67,72	85,83	101,18
<b>Seat depth in cm:</b> <i>Sitztiefe in cm:</i>	57	55	57	57	57
<b>Seat depth in inches:</b> <i>Sitztiefe in inches:</i>	22,44	21,65	22,44	22,44	22,44
<b>WxDxH(SH) in inches:</b>	29,92x30,32x29,53(17,32)	ø21,65x16,54	75,20x37,00x29,13(17,32)	95,66x42,52x29,13(17,32)	112,20x52,36x29,13(17,32)

## Configurations

### Frame:

Armchair, Sofa: Metal- wooden construction

Stool: Wooden construction

### Feet:

Armchair: Black metal swivel base with felt glides

Sofa: Black plastic feet with felt glides

Stool: Black wooden base with felt glides

### Upholstery:

Seat: Coil springs with polyurethane foams sandwich layered and dacron overlay

Backrest: Polyurethane foams sandwich layered with dacron overlay

Armrest shell: High-resilient polyurethane foams with dacron overlay

Stool: Polyurethane foams sandwich layered with dacron overlay

**Cover:** Fixed cover with piping

**Piping:** Same as cover

Without surcharge: Leather in standard colours Color Atlantic, Black, Cognac, Dark grey, Mocca, Sand, Siena and Taupe

## Ausführungen

### Gestell:

Fauteuil, Sofa: Metall- Holzkonstruktion

Hocker: Holzkonstruktion

### Füße:

Fauteuil: Metall Drehteller Schwarz mit Filzgleitern

Sofa: Schwarze Kunststofffüße mit Filzgleitern

Hocker: Schwarze Holzplatte mit Filzgleitern

### Polsterung:

Sitz: Federkern mit Polymousse Sandwichaufbau und Vliesabdeckung

Rückenlehne: Polymousse Sandwichaufbau mit Vliesabdeckung

Armteilschale: Hoch belastbarer Polyurethan Schaumstoff mit Vliesabdeckung

Hocker: Polymousse Sandwichaufbau mit Vliesabdeckung

**Bezug:** Fixbezug mit Keder

**Keder:** Wie Bezug

Auf Wunsch: Leder in Standardfarben Color Atlantic, Black, Cognac, Dark grey, Mocca, Sand, Siena und Taupe

# MONO Design: Marco Dessi

24612

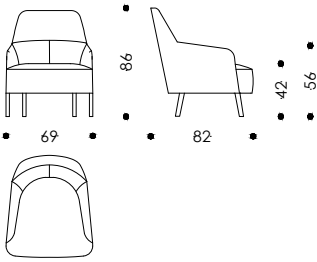

25112

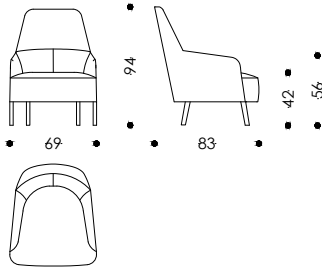

24617

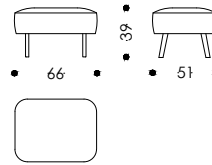

	24612	25112	24617
<b>Seat width in cm:</b> <i>Sitzbreite in cm:</i>	57	57	65
<b>Seat width in inches:</b> <i>Sitzbreite in inches:</i>	22,44	22,44	25,59
<b>Seat depth in cm:</b> <i>Sitztiefe in cm:</i>	56	56	50
<b>Seat depth in inches:</b> <i>Sitztiefe in inches:</i>	22,05	22,05	19,69
<b>WxDxH(SH) in inches:</b>	27,17x32,28x33,86(16,54)	27,17x32,28x37,00(16,54)	25,59x19,69x15,75

## Configurations

<b>Frame:</b>	Metal- wooden construction
<b>Legs:</b>	Beech solid Black with Teflon glides
<b>Surcharge:</b>	In Wittmann standard RAL colours or Walnut solid
<b>Upholstery:</b>	
<b>Seat:</b>	Elastic webbing, polyurethane foams sandwich layered with dacron overlay
<b>Shell:</b>	Polyurethane foams sandwich layered with dacron overlay
<b>Cover:</b>	Fixed cover

## Ausführungen

<b>Gestell:</b>	Metall- Holzkonstruktion
<b>Beine:</b>	Buche massiv Schwarz mit Teflongleitern
<b>Aufpreis:</b>	In Wittmann Standard RAL Farben oder Nuss massiv
<b>Polsterung:</b>	
<b>Sitz:</b>	Elastische Begurtung, Polymousse Sandwichaufbau mit Vliesabdeckung
<b>Schale:</b>	Polymousse Sandwichaufbau mit Vliesabdeckung
<b>Bezug:</b>	Fixbezug

# MORTON LOUNGE Design: Sebastian Herkner

22112

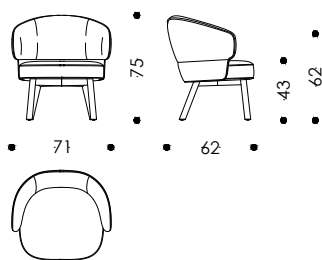

22113

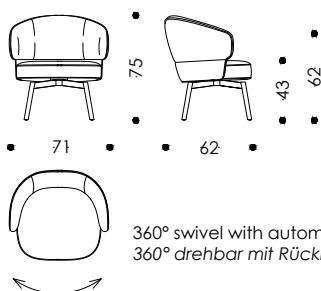

360° swivel with automatic return  
360° drehbar mit Rückholautomatik

	22112	22113
<b>Seat width in cm:</b> <i>Sitzbreite in cm:</i>	59	59
<b>Seat width in inches:</b> <i>Sitzbreite in inches:</i>	23,23	23,23
<b>Seat depth in cm:</b> <i>Sitztiefe in cm:</i>	52	52
<b>Seat depth in inches:</b> <i>Sitztiefe in inches:</i>	20,48	20,48
<b>WxDxH(SH) in inches:</b>	27,95x24,41x29,53(16,93)	27,95x24,41x29,53(16,93)

## Configurations

<b>Frame:</b>	Wooden construction with slightly flexible shell
<b>Legs (22112):</b>	Ash solid Black with Teflon glides
Surcharge:	Walnut solid
<b>Legs (22113):</b>	Metal Black Grey with Teflon glides, swivel mechanism with automatic return
<b>Upholstery:</b>	
<b>Seat:</b>	Pocket springs and polyurethane foams sandwich layered with dacron overlay
<b>Shell:</b>	Polyurethane foams sandwich layered with dacron overlay
<b>Cover:</b>	Fixed cover with piping
<b>Piping:</b>	Same as cover (unicolour), same as seat (multicolour)
<b>Without surcharge:</b>	Leather in standard colours Color Atlantic, Black, Cognac, Dark grey, Mocca, Sand, Siena and Taupe

## Ausführungen

<b>Gestell:</b>	Holzkonstruktion mit leicht flexible Schale
<b>Beine (22112):</b>	Esche massiv Schwarz mit Teflongleitern
Aufpreis:	Nuss massiv
<b>Beine (22113):</b>	Metall Black Grey mit Teflongleitern, Drehmechanismus mit Rückholautomatik
<b>Polsterung:</b>	
<b>Sitz:</b>	Taschenfederkern und Polymousse Sandwichaufbau mit Vliesabdeckung
<b>Schale:</b>	Polymousse Sandwichaufbau mit Vliesabdeckung
<b>Bezug:</b>	Fixbezug mit Keder
<b>Keder:</b>	Wie Bezug (einfärbig), Wie Sitz (mehrfärbig)
<b>Auf Wunsch:</b>	Leder in Standardfarben Color Atlantic, Black, Cognac, Dark grey, Mocca, Sand, Siena und Taupe

# OYSTER Design: Jörg Boner

23712

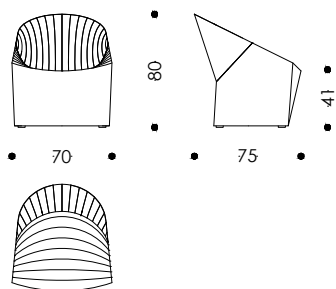

23717

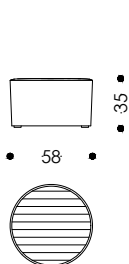

23720

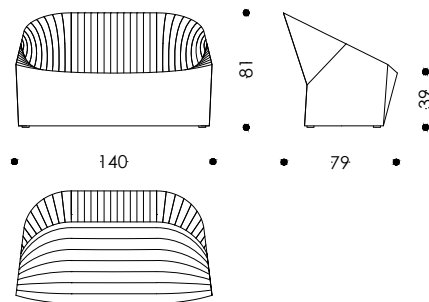

	23712	23717	23720
<b>Seat width in cm:</b> <i>Sitzbreite in cm:</i>	70	Ø58	140
<b>Seat width in inches:</b> <i>Sitzbreite in inches:</i>	27,55	Ø22,83	55,12
<b>Seat depth in cm:</b> <i>Sitztiefe in cm:</i>	56	Ø58	58
<b>Seat depth in inches:</b> <i>Sitztiefe in inches:</i>	22,05	Ø22,83	22,83
<b>WxDxH(SH) in inches:</b>	27,56x29,53x31,50(16,15)	Ø22,83x14,17	55,12x31,10x31,89(15,35)

## Configurations

<b>Frame:</b>	Metal- wooden construction
<b>Feet:</b>	Teflon glides
<b>Upholstery:</b>	
<b>Seat:</b>	Elastic webbing, polyurethane foams sandwich layered with dacron overlay
<b>Arm-, Backrest:</b>	Polyurethane foams with dacron overlay
<b>Cover:</b>	Fixed cover with stitched seams

## Ausführungen

<b>Gestell:</b>	Metall- Holzkonstruktion
<b>FüÙe:</b>	Teflingleiter
<b>Polsterung:</b>	
<b>Sitz:</b>	Elastische Begurtung, Polymousse Sandwichaufbau mit Vliesabdeckung
<b>Arm-, Rückenlehne:</b>	Polymousse mit Vliesabdeckung
<b>Bezug:</b>	Fixbezug mit Steppnaht

# PALAIS STOCLET Recreation Josef Hoffmann (Design: 1905)

9012

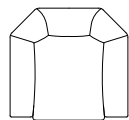
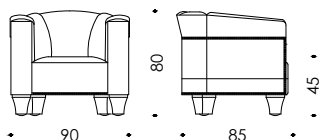

9030

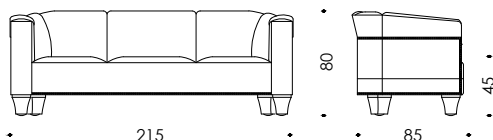

Please note that this product will be individually produced and the delivery time has to be requested/  
Bitte beachten Sie, dass dieses Modell in Einzelanfertigung hergestellt wird, daher ist die Lieferzeit vor Auftrag anzufragen

	9012	9030
Seat width in cm: <i>Sitzbreite in cm:</i>	50	175
Seat width in inches: <i>Sitzbreite in inches:</i>	19,69	68,90
Seat depth in cm: <i>Sitztiefe in cm:</i>	54	54
Seat depth in inches: <i>Sitztiefe in inches:</i>	21,26	21,26
WxDxH(SH) in inches:	35,43x33,46x31,50(17,72)	84,65x33,46x31,50(17,72)

## Configurations

<b>Frame:</b>	Metal- wooden construction
<b>Legs:</b>	Lime solid Black with metal-plastic glides
<b>Upholstery:</b>	
<b>Seat:</b>	Fixed webbing, coil springs with jute overlay, polyurethane foams and latex sandwich layered with dacron overlay
<b>Arm-, Backrest:</b>	Elastic webbing, polyurethane foams and Latex sandwich layered with dacron overlay
<b>Cover:</b>	Fixed cover with piping and upholstered buttons
<b>Piping, Buttons:</b>	Same as cover

## Ausführungen

<b>Gestell:</b>	Metall- Holzkonstruktion
<b>Beine:</b>	Linde massiv Schwarz mit Metall-Kunststoffgleitern
<b>Polsterung:</b>	
<b>Sitz:</b>	Starre Begurtung, Federkern mit Juteabdeckung, Polymousse und Latex Sandwichaufbau mit Vliesabdeckung
<b>Arm-, Rückenlehne:</b>	Elastische Begurtung, Polymousse und Latex Sandwichaufbau mit Vliesabdeckung
<b>Bezug:</b>	Fixbezug mit Keder und gepolsterten Knöpfen
<b>Keder, Knöpfe:</b>	Wie Bezug



# PARADISE BIRD

Design: Luca Nichetto

26412

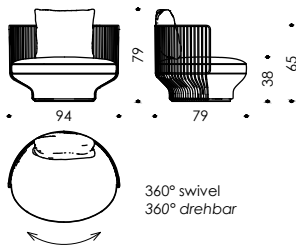

26418

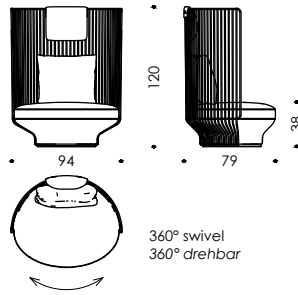

26420

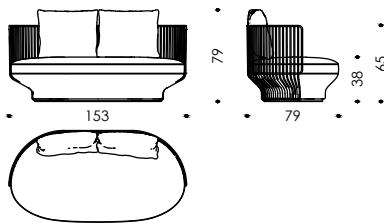

26417

26419

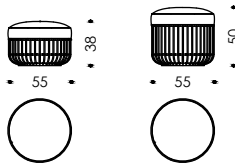

26460



	26412	26418	26420	26417	26419
<b>Seat width in cm:</b> <i>Sitzbreite in cm:</i>	90	90	148	Ø55	Ø55
<b>Seat width in inches:</b> <i>Sitzbreite in inches:</i>	35,34	35,34	58,27	Ø21,65	Ø21,65
<b>Seat depth in cm:</b> <i>Sitztiefe in cm:</i>	50	50	50	Ø55	Ø55
<b>Seat depth in inches:</b> <i>Sitztiefe in inches:</i>	19,69	19,69	19,69	Ø21,65	Ø21,65
<b>WxDxH(SH) in inches:</b>	37,00x31,10x31,10(14,96)	37,00x31,10x47,24(14,96)	60,24x31,10x31,10(14,96)	Ø21,65x14,96	Ø21,65x19,69

## Configurations

<b>Corpus:</b>	Metal- wooden construction
<b>Frame, Base ring:</b>	Metal Black Grey
<b>Surcharge:</b>	Brass Satin Matt or Soft Copper
<b>Feet:</b>	
Armchair, Highback Chair:	Metal swivel base with plastic glides
Sofa, Stool:	Plastic feet with felt glides
<b>Upholstery:</b>	
Seat:	Pocket springs and polyurethane foams sandwich layered with dacron overlay
Cushion:	100% feather filling with polyurethane core
<b>Cover:</b>	
Seat:	Fixed cover with piping
Cushion:	Removable cover, same as seat
<b>Piping:</b>	Same as cover
Without surcharge:	Leather in standard colours Color Atlantic, Black, Cognac, Dark grey, Mocca, Sand, Siena and Taupe

## Ausführungen

<b>Korpus:</b>	Metall- Holzkonstruktion
<b>Gestell, Basisring:</b>	Metall Black Grey
<b>Aufpreis:</b>	Messing Satin Matt oder Soft Copper
<b>FüÙe:</b>	
Fauteuil, Hochlehner:	Metall Drehteller mit Kunststoffgleitern
Sofa, Hocker:	KunststofffüÙe mit Filzgleitern
<b>Polsterung:</b>	
Sitz:	Taschenfederkern und Polymousse Sandwichaufbau mit Vliesabdeckung
Kissen:	100% Federnfüllung mit Polymousse Kern
<b>Bezug:</b>	
Sitz:	Fixbezug mit Keder
Kissen:	Bezug abnehmbar, wie Sitz
<b>Keder:</b>	Wie Bezug
Auf Wunsch:	Leder in Standardfarben Color Atlantic, Black, Cognac, Dark grey, Mocca, Sand, Siena und Taupe

# PARADISE BIRD FULLBACK Design: Luca Nichetto

26212

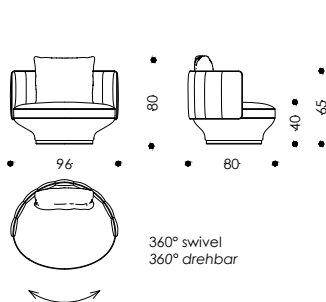

26218

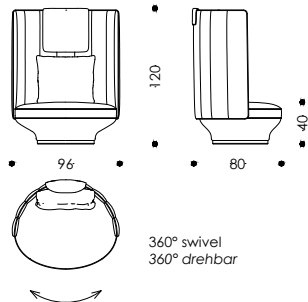

26220

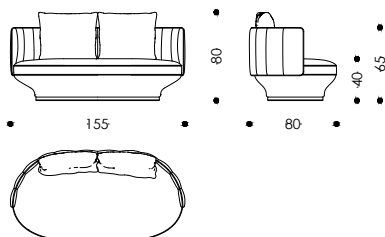

	26212	26218	26220
<b>Seat width in cm:</b> <i>Sitzbreite in cm:</i>	90	90	148
<b>Seat width in inches:</b> <i>Sitzbreite in inches:</i>	35,34	35,34	58,27
<b>Seat depth in cm:</b> <i>Sitztiefe in cm:</i>	50	50	50
<b>Seat depth in inches:</b> <i>Sitztiefe in inches:</i>	19,69	19,69	19,69
<b>WxDxH(SH) in inches:</b>	37,80x31,50x31,50(15,75)	37,80x31,50x47,24(15,75)	61,02x31,10x31,50(15,75)

## Configurations

<b>Frame:</b>	Metal- wooden construction
<b>Base ring:</b>	Metal- wooden construction
<b>Surcharge:</b>	Brass Satin Matt
<b>Feet:</b>	
Armchair, Highback Chair:	Metal swivel base with plastic glides
Sofa:	Plastic feet with felt glides
<b>Upholstery:</b>	
Seat:	Pocket springs and polyurethane foams sandwich layered with dacron overlay
Cushion:	100% feather filling with polyurethane core
Shell:	Polyurethane foams sandwich layered with dacron overlay
<b>Cover:</b>	
Seat, shell:	Fixed cover with piping
Cushion:	Same as seat, removable cover
<b>Piping:</b>	Same as cover
Without surcharge:	Piping on shell same as seat

## Ausführungen

<b>Gestell:</b>	<i>Metall- Holzkonstruktion</i>
<b>Basisring:</b>	<i>Metall- Holzkonstruktion</i>
<b>Aufpreis:</b>	<i>Messing Satin Matt</i>
<b>FüÙe:</b>	
<i>Fauteuil, Hochlehner:</i>	<i>Metall Drehteller mit Kunststoffgleitern</i>
Sofa:	<i>KunststofffüÙe mit Filzgleitern</i>
<b>Polsterung:</b>	
Sitz:	<i>Taschenfederkern und Polymousse Sandwichaufbau mit Vliesabdeckung</i>
Kissen:	<i>100% Federfüllung mit Polymousse Kern</i>
Schale:	<i>Polymousse Sandwichaufbau mit Vliesabdeckung</i>
<b>Bezug:</b>	
Sitz, Schale:	<i>Fixbezug mit Keder</i>
Kissen:	<i>Bezug wie Sitz, abnehmbar</i>
<b>Keder:</b>	<i>Wie Bezug</i>
Auf Wunsch:	<i>Keder auf Schale wie Sitz</i>

# PARADISE BIRD OUTDOOR Design: Luca Nichetto

27512

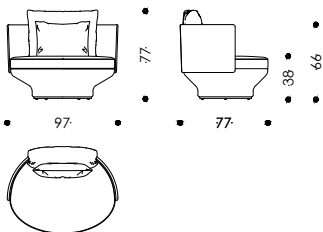

27512D

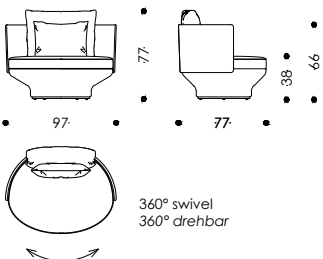

27520

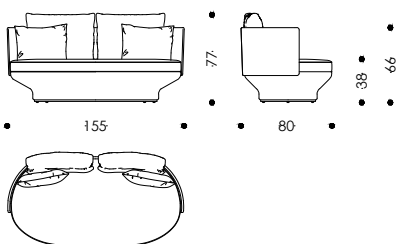

27517

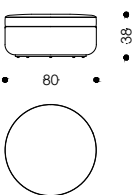

	27512	27512D	27520	27517
<b>Seat width in cm:</b> <i>Sitzbreite in cm:</i>	94	94	152	Ø80
<b>Seat width in inches:</b> <i>Sitzbreite in inches:</i>	37,00	37,00	59,84	Ø31,50
<b>Seat depth in cm:</b> <i>Sitztiefe in cm:</i>	55	55	60	Ø80
<b>Seat depth in inches:</b> <i>Sitztiefe in inches:</i>	21,65	21,65	23,62	Ø31,50
<b>WxDxH(SH) in inches:</b>	38,19x30,32x30,32(14,96)	38,19x30,32x30,32(14,96)	61,02x31,50x30,32(14,96)	Ø31,50x14,96

## Configurations

<b>Frame:</b>	Aluminium construction with fixed webbing, woven with ropes, plastic glides produced in partnership with Ethimo
<b>Corpus:</b>	Lava Grey
<b>Without surcharge:</b>	Light Grey or Lava&Light Grey
<b>Upholstery:</b>	Enclosed in waterproof cover
<b>Seat cushion:</b>	Polyurethane foams sandwich layered with dacron overlay
<b>Back cushion:</b>	Big: 100% Microflock filling, polyurethane core Small: 100% Microflock filling
<b>Cover:</b>	Removable cover
<b>Seat cushion:</b>	With piping (Piping same as cover)
<b>Back cushion:</b>	same as seat
<b>Cover fabrics:</b>	
<b>Semi-Outdoor:</b>	Indoor fabrics with outdoor suitability; Astonish, Twilltwenty
<b>Outdoor:</b>	Lopi, Majestic
<b>Rain Cover:</b>	Ethi-Care Fabric, Light grey

## Ausführungen

<b>Gestell:</b>	Aluminiumkonstruktion mit starrer Begurtung, mit Seilen gewebt, Kunststoffgleiter produziert in Partnerschaft mit Ethimo
<b>Korpus:</b>	Lava Grey
<b>Auf Wunsch:</b>	Light Grey oder Lava&Light Grey
<b>Polsterung:</b>	Abgedeckt mit wasserdichter Hülle
<b>Sitzkissen:</b>	Polymousse Sandwichaufbau mit Vliesabdeckung
<b>Rückenkissen:</b>	Groß: 100% Mikroflockfüllung, Polymousse Kern Klein: 100% Mikroflockfüllung
<b>Bezug:</b>	Bezug abnehmbar
<b>Sitzkissen:</b>	Mit Keder (Keder wie Bezug)
<b>Rückenkissen:</b>	Wie Sitz
<b>Bezugsstoffe:</b>	
<b>Semi-Outdoor:</b>	(Indoor Stoffe mit Outdoor Eignung) Astonish, Twilltwenty
<b>Outdoor:</b>	Lopi, Majestic
<b>Abdeckhaube:</b>	Ethi-Care Stoff, Hellgrau

# PARTY LOUNGE Re-Edition Friedrich Kiesler (Design: 1936)

18020

Figure with unfolded backrests/  
Abbildung mit ausgeklappten Rückenteilen

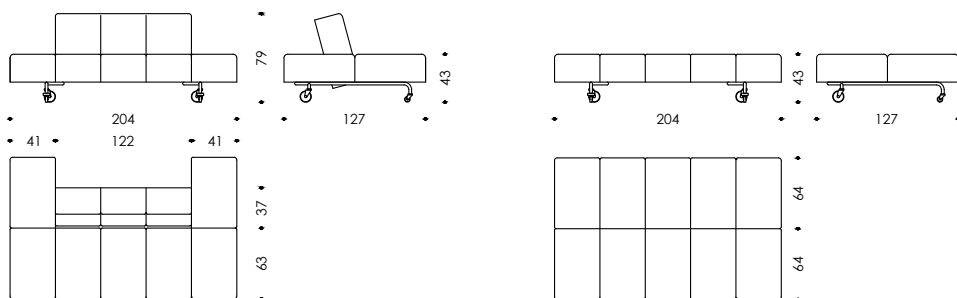

18020	
Seat width in cm: <i>Sitzbreite in cm:</i>	204
Seat width in inches: <i>Sitzbreite in inches:</i>	81,31
Seat depth in cm: <i>Sitztiefe in cm:</i>	63
Seat depth in inches: <i>Sitztiefe in inches:</i>	24,80
WxDxH(SH) in inches:	81,31x50,00x31,10(16,93)

## Configurations

<b>Frame:</b>	Wooden construction with foldable backrest
<b>Legs:</b>	Metal frame with lockable castors
<b>Upholstery:</b>	
<b>Seat:</b>	Fixed webbing, coil springs with jute overlay, polyurethane foams sandwich layered with dacron overlay
<b>Backrest:</b>	Fixed webbing, polyurethane foams sandwich layered with dacron overlay
<b>Cover:</b>	Fixed cover, seat and backrest partitioned with piping
<b>Piping:</b>	Same as cover

## Ausführungen

<b>Gestell:</b>	Holzkonstruktion mit klappbare Rückenlehne
<b>Beine:</b>	Metallrahmen mit Feststellrollen
<b>Polsterung:</b>	
<b>Sitz:</b>	Starre Begurtung, Federkern mit Juteabdeckung, Polymousse Sandwichaufbau mit Vliesabdeckung
<b>Rückenlehne:</b>	Starre Begurtung, Polymousse Sandwichaufbau mit Vliesabdeckung
<b>Bezug:</b>	Fixbezug, Sitz und Rückenlehne mit Keder geteilt
<b>Keder:</b>	Wie Bezug

# PLAYTIME Design: Soda Designers

## Combination Examples/ Kombinationsbeispiele

### Combination Example 1/ Kombinationsbeispiel 1

- 1x Middle Element 231 L stitched/ *Zwischenelement 231 L geheftet* (26358)
- 1x Stool Tray 63 stitched/ *Hockerablage 63 geheftet* (26371)
- 1x Armrest 80/ *Armteil 80* (26269)

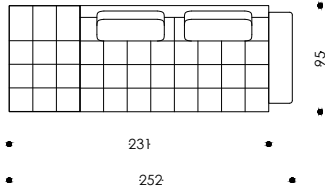

### Combination Example 2/ Kombinationsbeispiel 2

- 1x Armrest 80/ *Armteil 80* (26269)
- 1x Middle Element 231 R stitched/ *Zwischenelement 231 R geheftet* (26359)
- 1x Chaise Longue 84 plain/ *Chaiselongue 84 glatt* (26262)
- 1x Armrest 101/ *Armteil 101* (26270)

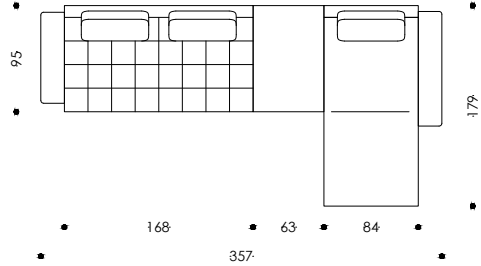

### Combination Example 3/ Kombinationsbeispiel 3

- 1x End Element 137 L stitched/ *Abschlusselement 137 L geheftet* (26342)
- 1x Special Element 204 R plain/ *Sonderelement 204 R glatt* (26264)
- 1x Stool stitched/ *Hocker geheftet* (26365)

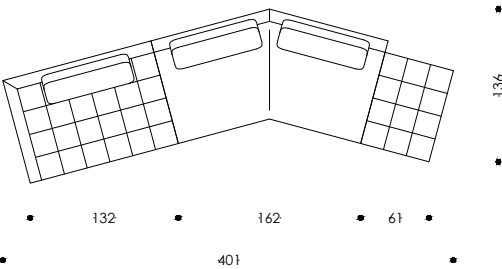

### Combination Example 4/ Kombinationsbeispiel 4

- 1x End Element 242 L stitched/ *Abschlusselement 242 L geheftet* (26350)
- 1x End Element 242 L plain/ *Abschlusselement 242 L glatt* (26250)
- 1x Stool Cushion 63 stitched/ *Hockerablage 63 geheftet* (26371)

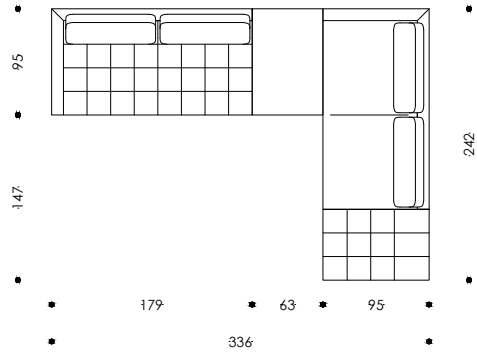

### Combination Example 5/ Kombinationsbeispiel 5

- 1x Armrest 80/ *Armteil 80* (26269)
- 1x Special Element 204/ *Sonderelement 204* (26264)
- 1x Middle Element 189 R plain/ *Zwischenelement 189 R glatt* (26257)
- 1x Chaise Longue 126 stitched/ *Chaiselongue 126 geheftet* (26363)
- 1x Armrest 101/ *Armteil 101* (26270)

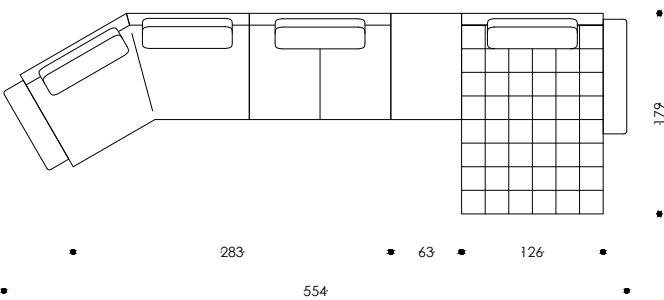

### Combination Example 6/ Kombinationsbeispiel 6

- 1x Middle Element 231 plain L/ *Zwischenelement 231 L glatt* (26258)
- 1x Special Element 232 plain/ *Sonderelement 232 glatt* (26265)
- 1x Middle Element 231 R stitched/ *Zwischenelement 231 R geheftet* (26359)

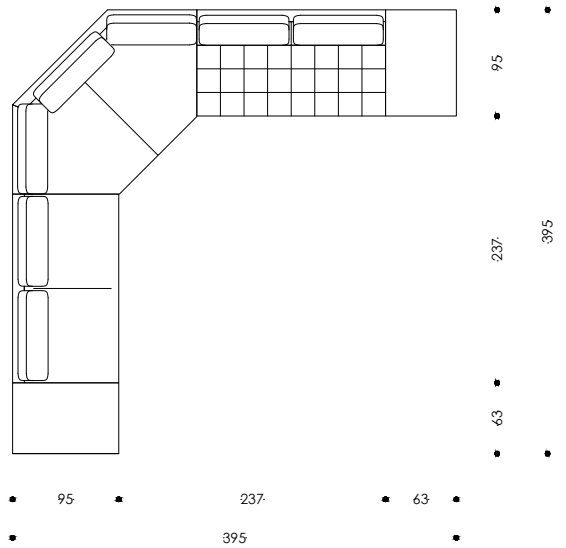

# PLAYTIME Design: Soda Designers

## Overview Elements/ Übersicht Elemente

### Sofas/ Sofas

26221

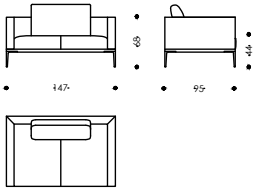

26225

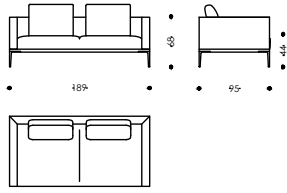

26230

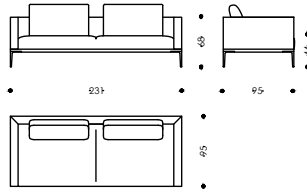

26235

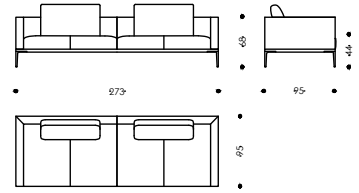

26320

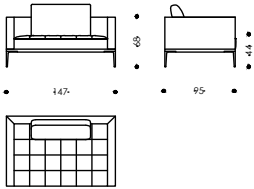

26325

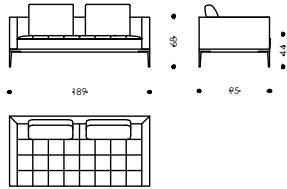

26330

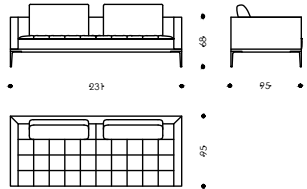

26335

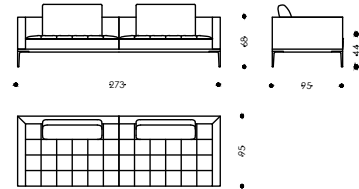

### End Elements/ Abschlüsselemente

26241 (R) / 26242 (L)

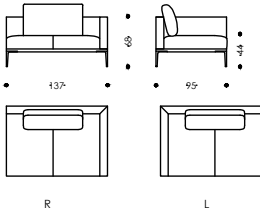

26243 (R) / 26244 (L)

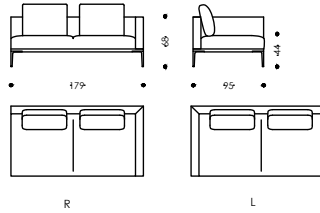

26245 (R) / 26246 (L)

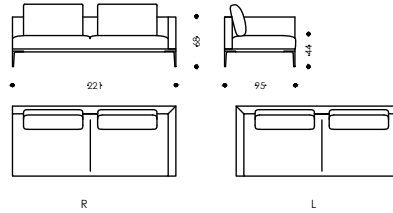

26364

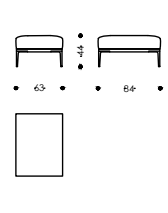

26341 (R) / 26342 (L)

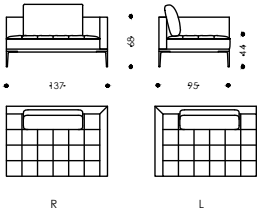

26343 (R) / 26344 (L)

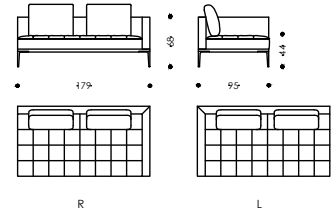

26345 (R) / 26346 (L)

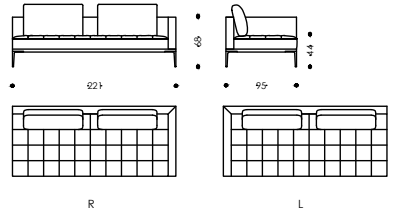

26365

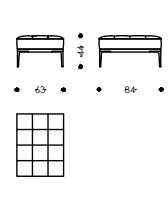

### Middle Elements/ Zwischenelemente

26253

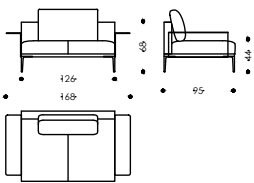

26254

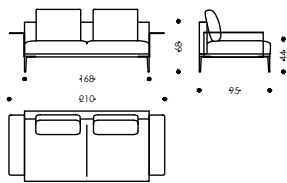

26255

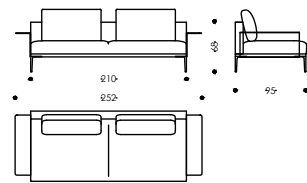

26353

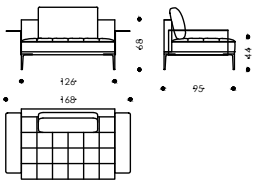

26354

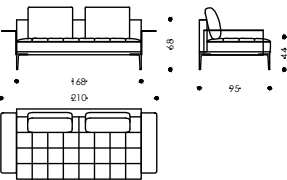

26355

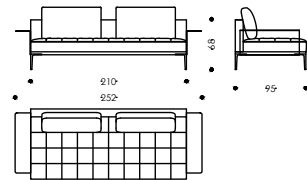

### Accessories - Back Cushions, Stooltrays, Armrests/ Accessoires - Lehnkissen, Hockerablagen, Armteilen

26266



26267

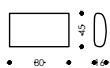

26271

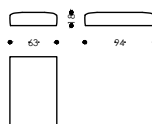

26371

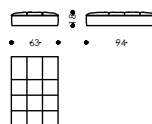

26269

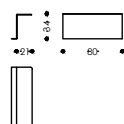

26270

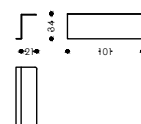

# PLAYTIME Design: Soda Designers

## Overview Elements/ Übersicht Elemente

### End Elements with Tray/ Abschlusselemente mit Ablage

26247 (R) / 26248 (L)

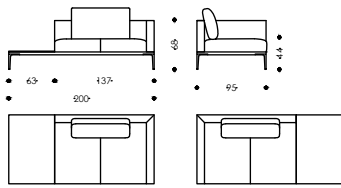

R

L

26249 (R) / 26250 (L)

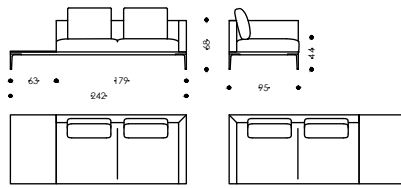

R

L

26251 (R) / 26252 (L)

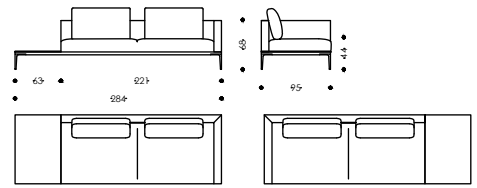

R

L

26347 (R) / 26348 (L)

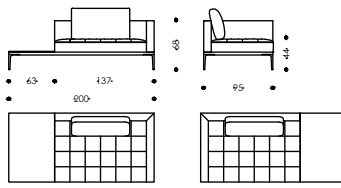

R

L

26349 (R) / 26350 (L)

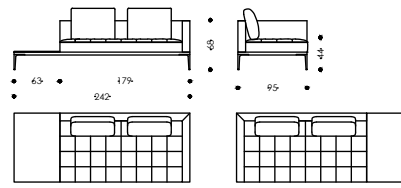

R

L

26351 (R) / 26352 (L)

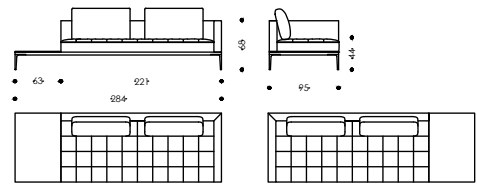

R

L

### Middle Elements with Tray/ Zwischenelemente mit Ablage

26257 (R) / 26256 (L)

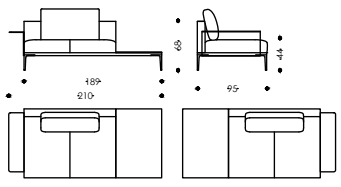

R

L

26259 (R) / 26258 (L)

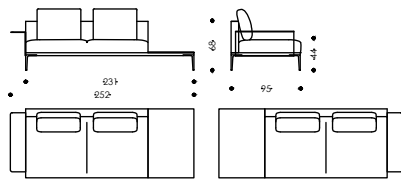

R

L

26261 (R) / 26260 (L)

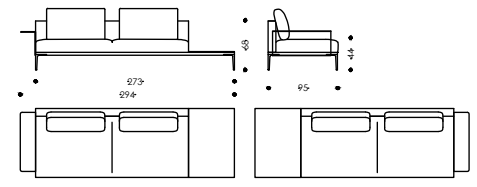

R

L

26357 (R) / 26356 (L)

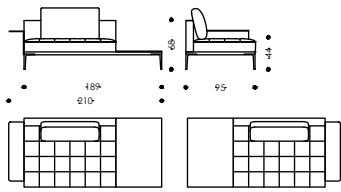

R

L

26359 (R) / 26358 (L)

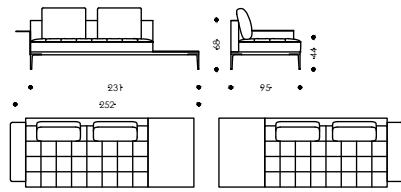

R

L

26361 (R) / 26360 (L)

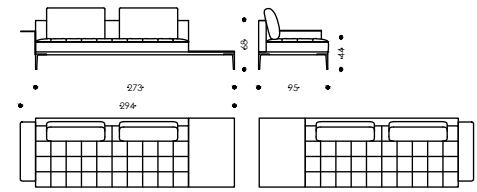

R

L

### Daybeds and Special Elements/ Liegen und Sonderelemente

26262

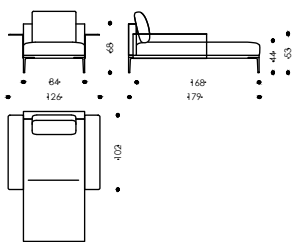

26263

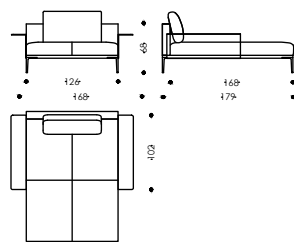

26264

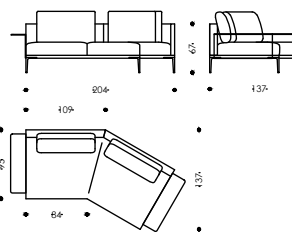

26265

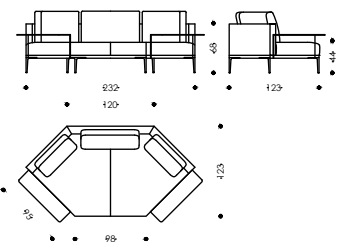

26362

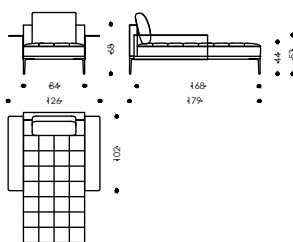

26363

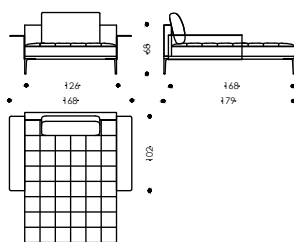

# PLAYTIME

Design: Soda Designers

26221

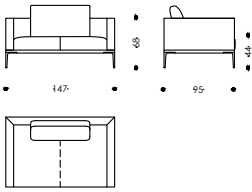

26225

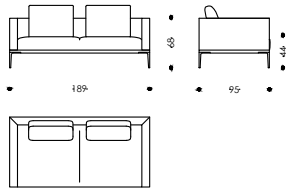

26230

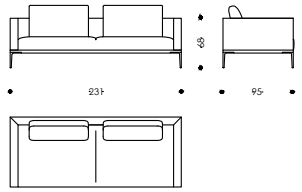

26235

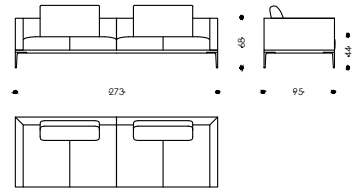

26320

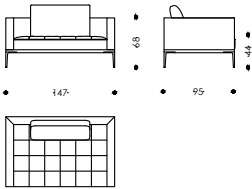

26325

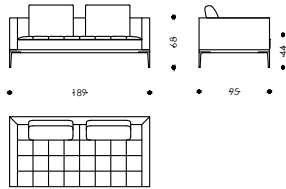

26330

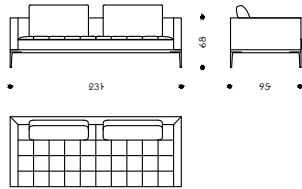

26335

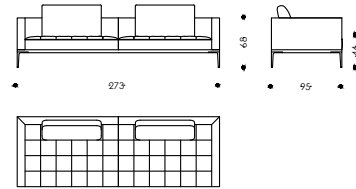

For element groups please attach a drawing to the order/ Bei einer Gruppenbestellung ist unbedingt eine Skizze beizufügen

	26221/ 26320	26225/ 26325	26230/ 26330	26235/ 26335
<b>Seat width in cm:</b> <b>Sitzbreite in cm:</b>	126	168	210	252
<b>Seat width in inches:</b> <b>Sitzbreite in inches:</b>	49,61	66,14	82,68	99,21
<b>Seat depth in cm:</b> <b>Sitztiefe in cm:</b>	58	58	58	58
<b>Seat depth in inches:</b> <b>Sitztiefe in inches:</b>	22,83	22,83	22,83	22,83
<b>WxDxH(SH) in inches:</b>	57,87x37,40x26,77(17,32)	74,41x37,40x26,77(17,32)	90,95x37,40x26,77(17,32)	107,48x37,40x26,77(17,32)

## Configurations

<b>Frame:</b>	Metal- wooden construction
<b>Legs:</b>	Metal Bronze with leather fiber glides
<b>Surcharge:</b>	Black Grey
<b>Upholstery:</b>	
<b>Seat:</b>	Fixed webbing, pocket springs and polyurethane foams sandwich layered with dacron overlay
<b>Arm-, Backrest:</b>	Polyurethane foams sandwich layered with dacron overlay
<b>Back Cushion:</b>	100% Feather filling with polyurethane core
<b>Cover:</b>	
<b>Arm-, Backrest:</b>	Fixed cover
<b>Seat (plain):</b>	Fixed cover
<b>Seat (stitched):</b>	Fixed cover with stitched seam, concealed-tacking
<b>Back Cushion:</b>	Removable cover

## Ausführungen

<b>Gestell:</b>	Metall- Holzkonstruktion
<b>Beine:</b>	Metall Bronze mit Lederfasergleitern
<b>Aufpreis:</b>	Black Grey
<b>Polsterung:</b>	
<b>Sitz:</b>	Starre Begurtung, Taschenfederkern und Polymousse Sandwichaufbau mit Vliesabdeckung
<b>Arm-, Rückenlehne:</b>	Polymousse Sandwichaufbau mit Vliesabdeckung
<b>Lehnkissen:</b>	100% Federnfüllung mit Polymousse Kern
<b>Bezug:</b>	
<b>Arm-, Rückenlehne:</b>	Fixbezug
<b>Sitz (glatt):</b>	Fixbezug
<b>Sitz (geheftet):</b>	Fixbezug mit Steppnaht, Blindheftung
<b>Lehnkissen:</b>	Bezug abnehmbar



# PLAYTIME Design: Soda Designers

26241 (R) / 26242 (L)

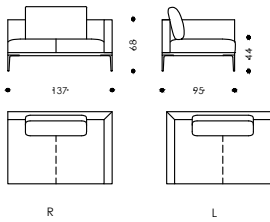

26243 (R) / 26244 (L)

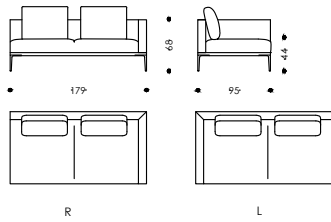

26245 (R) / 26246 (L)

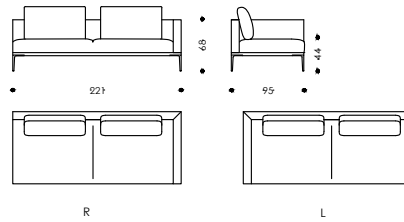

26364

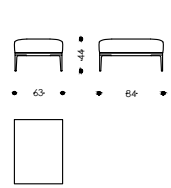

26341 (R) / 26342 (L)

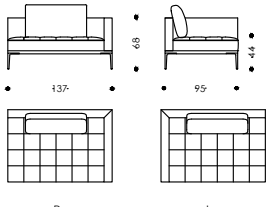

26343 (R) / 26344 (L)

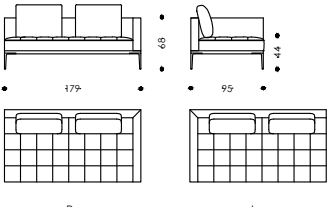

26345 (R) / 26346 (L)

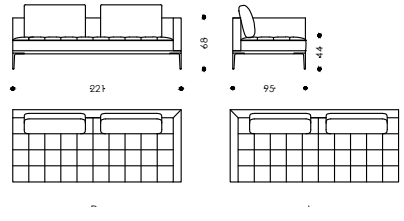

26365

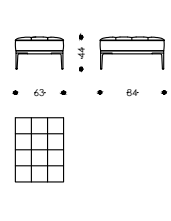

Elements can be combined with leather-covered armrests / Elemente sind mit lederbezogenen Armteilen kombinierbar  
 For element groups please attach a drawing to the order / Bei einer Gruppenbestellung ist unbedingt eine Skizze beizufügen

	26241/ 26242 26341/ 26342	26243/ 26244 26343/ 26344	26245/ 26246 26345/ 26346	26364/ 26365
<b>Seat width in cm:</b> <b>Sitzbreite in cm:</b>	126	168	210	84
<b>Seat width in inches:</b> <b>Sitzbreite in inches:</b>	49,61	66,14	82,68	33,07
<b>Seat depth in cm:</b> <b>Sitztiefe in cm:</b>	58	58	58	63
<b>Seat depth in inches:</b> <b>Sitztiefe in inches:</b>	22,83	22,83	22,83	24,80
<b>WxDxH(SH) in inches:</b>	57,87x37,40x26,77(17,32)	74,41x37,40x26,77(17,32)	90,95x37,40x26,77(17,32)	33,07x24,80x17,32

## Configurations

<b>Frame:</b>	Metal- wooden construction
<b>Legs:</b>	Metal Bronze with leather fiber glides
<b>Surcharge:</b>	Black Grey
<b>Upholstery:</b>	
<b>Seat:</b>	Fixed webbing, pocket springs and polyurethane foams sandwich layered with dacron overlay
<b>Arm-, Backrest:</b>	Polyurethane foams sandwich layered with dacron overlay
<b>Back Cushion:</b>	100% Feather filling with polyurethane core
<b>Cover:</b>	
<b>Arm-, Backrest:</b>	Fixed cover
<b>Seat (plain):</b>	Fixed cover
<b>Seat (stitched):</b>	Fixed cover with stitched seam, concealed-tacking
<b>Back Cushion:</b>	Removable cover

## Ausführungen

<b>Gestell:</b>	Metall- Holzkonstruktion
<b>Beine:</b>	Metall Bronze mit Lederfasergleitern
<b>Aufpreis:</b>	Metall Black Grey
<b>Polsterung:</b>	
<b>Sitz:</b>	Starre Begurtung, Taschenfederkern und Polymousse Sandwichaufbau mit Vliesabdeckung
<b>Arm-, Rückenlehne:</b>	Polymousse Sandwichaufbau mit Vliesabdeckung
<b>Lehnkissen:</b>	100% Federnfüllung mit Polymousse Kern
<b>Bezug:</b>	
<b>Arm-, Rückenlehne:</b>	Fixbezug
<b>Sitz (glatt):</b>	Fixbezug
<b>Sitz (geheftet):</b>	Fixbezug mit Steppnaht, Blindheftung
<b>Lehnkissen:</b>	Bezug abnehmbar

# PLAYTIME Design: Soda Designers

26253

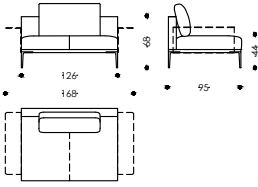

26254

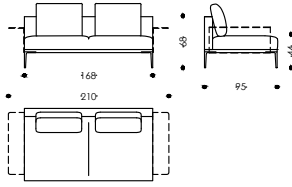

26255

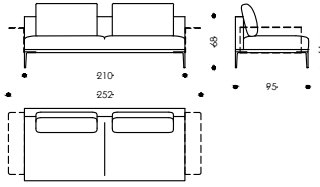

26266



26353

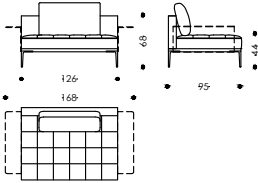

26354

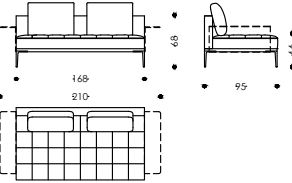

26355

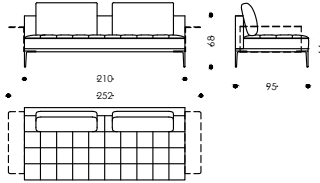

26267



Elements can be combined with leather-covered armrests/ Elemente sind mit lederbezogenen Armteilen kombinierbar

For element groups please attach a drawing to the order/ Bei einer Gruppenbestellung ist unbedingt eine Skizze beizufügen

	26253/ 26353	26254/ 26354	26255/ 26355	26266	26267
Seat width in cm: Sitzbreite in cm:	126	168	210	-	-
Seat width in inches: Sitzbreite in inches:	49,61	66,14	82,68	-	-
Seat depth in cm: Sitztiefe in cm:	58	58	58	-	-
Seat depth in inches: Sitztiefe in inches:	22,83	22,83	22,83	-	-
WxDxH(SH) in inches:	57,87x37,40x26,77(17,32)	74,41x37,40x26,77(17,32)	90,95x37,40x26,77(17,32)	23,62x6,30x17,72	31,50x6,30x17,72

## Configurations

<b>Frame:</b>	Metal- wooden construction
<b>Legs:</b>	Metal Bronze with leather fiber glides
<b>Surcharge:</b>	Black Grey
<b>Upholstery:</b>	
<b>Seat:</b>	Fixed webbing, pocket springs and polyurethane foams sandwich layered with dacron overlay
<b>Arm-, Backrest:</b>	Polyurethane foams sandwich layered with dacron overlay
<b>Back Cushion:</b>	100% Feather filling with polyurethane core
<b>Cover:</b>	
<b>Arm-, Backrest:</b>	Fixed cover
<b>Seat (plain):</b>	Fixed cover
<b>Seat (stitched):</b>	Fixed cover with stitched seam, concealed-tacking
<b>Back Cushion:</b>	Removable cover

## Ausführungen

<b>Gestell:</b>	Metall- Holzkonstruktion
<b>Beine:</b>	Metall Bronze mit Lederfasergleitern
<b>Aufpreis:</b>	Metall Black Grey
<b>Polsterung:</b>	
<b>Sitz:</b>	Starre Begurtung, Taschenfederkern und Polymousse Sandwichaufbau mit Vliesabdeckung
<b>Arm-, Rückenlehne:</b>	Polymousse Sandwichaufbau mit Vliesabdeckung
<b>Lehnkissen:</b>	100% Federnfüllung mit Polymousse Kern
<b>Bezug:</b>	
<b>Arm-, Rückenlehne:</b>	Fixbezug
<b>Sitz (glatt):</b>	Fixbezug
<b>Sitz (geheftet):</b>	Fixbezug mit Steppnaht, Blindheftung
<b>Lehnkissen:</b>	Bezug abnehmbar

# PLAYTIME Design: Soda Designers

26247 (R) / 26248 (L)

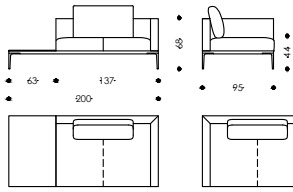

R

L

26249 (R) / 26250 (L)

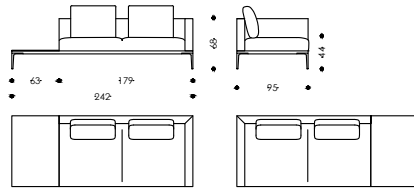

R

L

26251 (R) / 26252 (L)

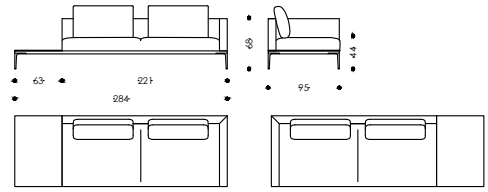

R

L

26271

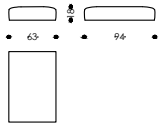

26371

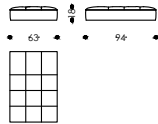

Tray can be replaced with stool tray/ Ablage kann durch Hockerablage ersetzt werden

For element groups please attach a drawing to the order/ Bei einer Gruppenbestellung ist unbedingt eine Skizze beizufügen

To prevent potential dirt on tray surface, it is recommended to use a separate tray/

Um eine mögliche Verschmutzung der Ablagefläche zu vermeiden, wird empfohlen, ein separates Tablett zu verwenden

	26247/ 26248	26249/ 26250	26251/ 26252	26271/ 26371
<b>Seat width in cm:</b> <i>Sitzbreite in cm:</i>	126	168	210	210
<b>Seat width in inches:</b> <i>Sitzbreite in inches:</i>	49,61	66,14	82,68	82,68
<b>Seat depth in cm:</b> <i>Sitztiefe in cm:</i>	58	58	58	58
<b>Seat depth in inches:</b> <i>Sitztiefe in inches:</i>	22,83	22,83	22,83	22,83
<b>WxDxH(SH) in inches:</b>	57,87x37,40x26,77(17,32)	74,41x37,40x26,77(17,32)	90,95x37,40x26,77(17,32)	90,95x37,40x26,77(17,32)

## Configurations

<b>Frame:</b>	Metal- wooden construction
<b>Legs:</b>	Metal Bronze with leather fiber glides
<b>Surcharge:</b>	Black Grey
<b>Upholstery:</b>	
<b>Seat, Stool cushion:</b>	Fixed webbing, pocket springs and polyurethane foams sandwich layered with dacron overlay
<b>Arm-, Backrest:</b>	Polyurethane foams sandwich layered with dacron overlay
<b>Back Cushion:</b>	100% Feather filling with polyurethane core
<b>Cover:</b>	
<b>Arm-, Backrest:</b>	Fixed cover
<b>Seat (plain):</b>	Fixed cover
<b>Seat (stitched):</b>	Fixed cover with stitched seam, concealed-tacking
<b>Back Cushion:</b>	Removable cover
<b>Tray:</b>	Walnut veneer
<b>Surcharge:</b>	Covered in leather

## Ausführungen

<b>Gestell:</b>	Metall- Holzkonstruktion
<b>Beine:</b>	Metall Bronze mit Lederfasergleitern
<b>Aufpreis:</b>	Metall Black Grey
<b>Polsterung:</b>	
<b>Sitz, Hockerablage:</b>	Starre Begurtung, Taschenfederkern und Polymousse Sandwichaufbau mit Vliesabdeckung
<b>Arm-, Rückenlehne:</b>	Polymousse Sandwichaufbau mit Vliesabdeckung
<b>Lehnkissen:</b>	100% Federnfüllung mit Polymousse Kern
<b>Bezug:</b>	
<b>Arm-, Rückenlehne:</b>	Fixbezug
<b>Sitz (glatt):</b>	Fixbezug
<b>Sitz (geheftet):</b>	Fixbezug mit Steppnaht, Blindheftung
<b>Lehnkissen:</b>	Bezug abnehmbar
<b>Ablage:</b>	Nuss furniert
<b>Aufpreis:</b>	Lederbezogen

# PLAYTIME Design: Soda Designers

26347 (R) / 26348 (L)

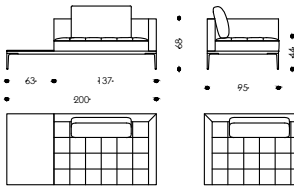

R

L

26349 (R) / 26350 (L)

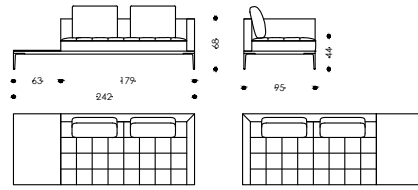

R

L

26351 (R) / 26352 (L)

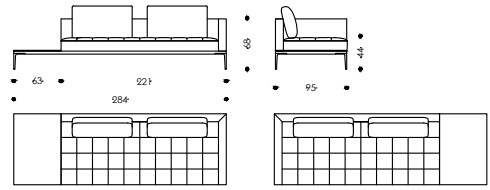

R

L

26271

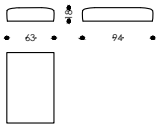

26371

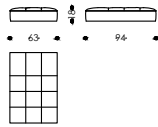

Tray can be replaced with stool tray/ Ablage kann durch Hockerablage ersetzt werden

For element groups please attach a drawing to the order/ Bei einer Gruppenbestellung ist unbedingt eine Skizze beizufügen

To prevent potential dirt on tray surface, it is recommended to use a separate tray/

Um eine mögliche Verschmutzung der Ablagefläche zu vermeiden, wird empfohlen, ein separates Tablett zu verwenden

	26347/ 26348	26349/ 26350	26351/ 26352	26271/ 26371
<b>Seat width in cm:</b> <i>Sitzbreite in cm:</i>	126	168	210	210
<b>Seat width in inches:</b> <i>Sitzbreite in inches:</i>	49,61	66,14	82,68	82,68
<b>Seat depth in cm:</b> <i>Sitztiefe in cm:</i>	58	58	58	58
<b>Seat depth in inches:</b> <i>Sitztiefe in inches:</i>	22,83	22,83	22,83	22,83
<b>WxDxH(SH) in inches:</b>	57,87x37,40x26,77(17,32)	74,41x37,40x26,77(17,32)	90,95x37,40x26,77(17,32)	90,95x37,40x26,77(17,32)

## Configurations

<b>Frame:</b>	Metal- wooden construction
<b>Legs:</b>	Metal Bronze with leather fiber glides
<b>Surcharge:</b>	Black Grey
<b>Upholstery:</b>	
<b>Seat, Stool cushion:</b>	Fixed webbing, pocket springs and polyurethane foams sandwich layered with dacron overlay
<b>Arm-, Backrest:</b>	Polyurethane foams sandwich layered with dacron overlay
<b>Back Cushion:</b>	100% Feather filling with polyurethane core
<b>Cover:</b>	
<b>Arm-, Backrest:</b>	Fixed cover
<b>Seat (plain):</b>	Fixed cover
<b>Seat (stitched):</b>	Fixed cover with stitched seam, concealed-tacking
<b>Back Cushion:</b>	Removable cover
<b>Tray:</b>	Walnut veneer
<b>Surcharge:</b>	Covered in leather

## Ausführungen

<b>Gestell:</b>	Metall- Holzkonstruktion
<b>Beine:</b>	Metall Bronze mit Lederfasergleitern
<b>Aufpreis:</b>	Metall Black Grey
<b>Polsterung:</b>	
<b>Sitz, Hockerablage:</b>	Starre Begurtung, Taschenfederkern und Polymousse Sandwichaufbau mit Vliesabdeckung
<b>Arm-, Rückenlehne:</b>	Polymousse Sandwichaufbau mit Vliesabdeckung
<b>Lehnkissen:</b>	100% Federnfüllung mit Polymousse Kern
<b>Bezug:</b>	
<b>Arm-, Rückenlehne:</b>	Fixbezug
<b>Sitz (glatt):</b>	Fixbezug
<b>Sitz (geheftet):</b>	Fixbezug mit Steppnaht, Blindheftung
<b>Lehnkissen:</b>	Bezug abnehmbar
<b>Ablage:</b>	Nuss furniert
<b>Aufpreis:</b>	Lederbezogen

# PLAYTIME Design: Soda Designers

26257 (R) / 26256 (L)

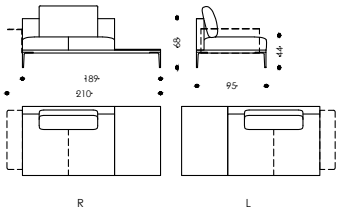

26259 (R) / 26258 (L)

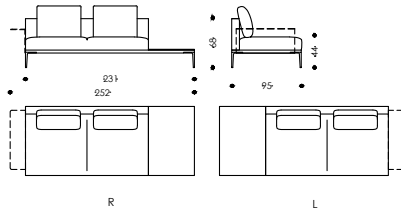

26261 (R) 26260 (L)

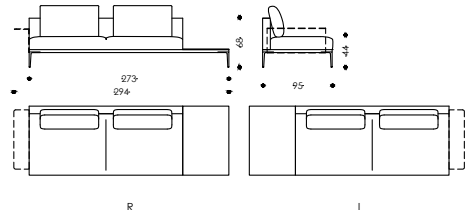

26271

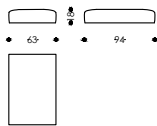

26371

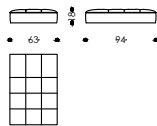

Elements can be combined with leather-covered armrests/ *Elemente sind mit lederbezogenen Armteilen kombinierbar*

Tray can be replaced with stool cushions/ *Ablage kann durch Hockerablage ersetzt werden*

For element groups please attach a drawing to the order/ *Bei einer Gruppenbestellung ist unbedingt eine Skizze beizufügen*

To prevent potential dirt on tray surface, it is recommended to use a separate tray/

*Um eine mögliche Verschmutzung der Ablagefläche zu vermeiden, wird empfohlen, ein separates Tablett zu verwenden*

	26257/ 26256	26259/ 26258	26261/ 26260	26271/ 26371
<b>Seat width in cm:</b> <i>Sitzbreite in cm:</i>	126	168	210	210
<b>Seat width in inches:</b> <i>Sitzbreite in inches:</i>	49,61	66,14	82,68	82,68
<b>Seat depth in cm:</b> <i>Sitztiefe in cm:</i>	58	58	58	58
<b>Seat depth in inches:</b> <i>Sitztiefe in inches:</i>	22,83	22,83	22,83	22,83
<b>WxDxH(SH) in inches:</b>	57,87x37,40x26,77(17,32)	74,41x37,40x26,77(17,32)	90,95x37,40x26,77(17,32)	90,95x37,40x26,77(17,32)

## Configurations

<b>Frame:</b>	Metal- wooden construction
<b>Legs:</b>	Metal Bronze with leather fiber glides
<b>Surcharge:</b>	Black Grey
<b>Upholstery:</b>	
<b>Seat, Stool cushion:</b>	Fixed webbing, pocket springs and polyurethane foams sandwich layered with dacron overlay
<b>Arm-, Backrest:</b>	Polyurethane foams sandwich layered with dacron overlay
<b>Back Cushion:</b>	100% Feather filling with polyurethane core
<b>Cover:</b>	
<b>Arm-, Backrest:</b>	Fixed cover
<b>Seat (plain):</b>	Fixed cover
<b>Seat (stitched):</b>	Fixed cover with stitched seam, concealed-tacking
<b>Back Cushion:</b>	Removable cover
<b>Tray:</b>	Walnut veneer
<b>Surcharge:</b>	Covered in leather

## Ausführungen

<b>Gestell:</b>	Metall- Holzkonstruktion
<b>Beine:</b>	Metall Bronze mit Lederfasergleitern
<b>Aufpreis:</b>	Metall Black Grey
<b>Polsterung:</b>	
<b>Sitz, Hockerablage:</b>	Starre Begurtung, Taschenfederkern und Polymousse Sandwichaufbau mit Vliesabdeckung
<b>Arm-, Rückenlehne:</b>	Polymousse Sandwichaufbau mit Vliesabdeckung
<b>Lehnkissen:</b>	100% Federnfüllung mit Polymousse Kern
<b>Bezug:</b>	
<b>Arm-, Rückenlehne:</b>	Fixbezug
<b>Sitz (glatt):</b>	Fixbezug
<b>Sitz (geheftet):</b>	Fixbezug mit Steppnaht, Blindheftung
<b>Lehnkissen:</b>	Bezug abnehmbar
<b>Ablage:</b>	Nuss furniert
<b>Aufpreis:</b>	Lederbezogen

# PLAYTIME Design: Soda Designers

26357 (R) / 26356 (L)

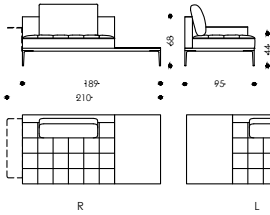

26359 (R) / 26358 (L)

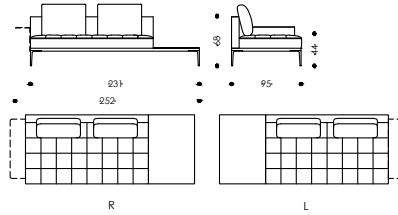

26361 (R) / 26360 (L)

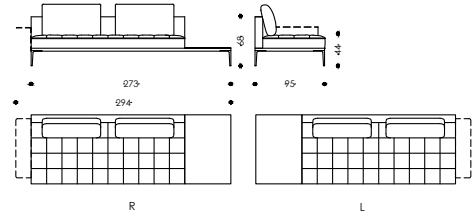

26271

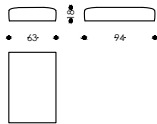

26371

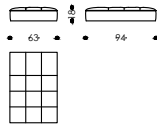

Elements can be combined with leather-covered armrests/ *Elemente sind mit lederbezogenen Armteilen kombinierbar*

Tray can be replaced with stool cushions/ *Ablage kann durch Stoolablage ersetzt werden*

For element groups please attach a drawing to the order/ *Bei einer Gruppenbestellung ist unbedingt eine Skizze beizufügen*

To prevent potential dirt on tray surface, it is recommended to use a separate tray/

*Um eine mögliche Verschmutzung der Ablagefläche zu vermeiden, wird empfohlen, ein separates Tablett zu verwenden*

	26357/ 26356	26359/ 26358	26361/ 26360	26271/ 26371
<b>Seat width in cm:</b> <i>Sitzbreite in cm:</i>	126	168	210	210
<b>Seat width in inches:</b> <i>Sitzbreite in inches:</i>	49,61	66,14	82,68	82,68
<b>Seat depth in cm:</b> <i>Sitztiefe in cm:</i>	58	58	58	58
<b>Seat depth in inches:</b> <i>Sitztiefe in inches:</i>	22,83	22,83	22,83	22,83
<b>WxDxH(SH) in inches:</b>	57,87x37,40x26,77(17,32)	74,41x37,40x26,77(17,32)	90,95x37,40x26,77(17,32)	90,95x37,40x26,77(17,32)

## Configurations

<b>Frame:</b>	Metal- wooden construction
<b>Legs:</b>	Metal Bronze with leather fiber glides
<b>Surcharge:</b>	Black Grey
<b>Upholstery:</b>	
<b>Seat, Stool cushion:</b>	Fixed webbing, pocket springs and polyurethane foams sandwich layered with dacron overlay
<b>Arm-, Backrest:</b>	Polyurethane foams sandwich layered with dacron overlay
<b>Back Cushion:</b>	100% Feather filling with polyurethane core
<b>Cover:</b>	
<b>Arm-, Backrest:</b>	Fixed cover
<b>Seat (plain):</b>	Fixed cover
<b>Seat (stitched):</b>	Fixed cover with stitched seam, concealed-tacking
<b>Back Cushion:</b>	Removable cover
<b>Tray:</b>	Walnut veneer
<b>Surcharge:</b>	Covered in leather

## Ausführungen

<b>Gestell:</b>	Metall- Holzkonstruktion
<b>Beine:</b>	Metall Bronze mit Lederfasergleitern
<b>Aufpreis:</b>	Metall Black Grey
<b>Polsterung:</b>	
<b>Sitz, Hockerablage:</b>	Starre Begurtung, Taschenfederkern und Polymousse Sandwichaufbau mit Vliesabdeckung
<b>Arm-, Rückenlehne:</b>	Polymousse Sandwichaufbau mit Vliesabdeckung
<b>Lehnkissen:</b>	100% Federnfüllung mit Polymousse Kern
<b>Bezug:</b>	
<b>Arm-, Rückenlehne:</b>	Fixbezug
<b>Sitz (glatt):</b>	Fixbezug
<b>Sitz (geheftet):</b>	Fixbezug mit Steppnaht, Blindheftung
<b>Lehnkissen:</b>	Bezug abnehmbar
<b>Ablage:</b>	Nuss furniert
<b>Aufpreis:</b>	Lederbezogen

# PLAYTIME Design: Soda Designers

26262

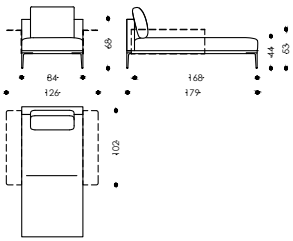

26263

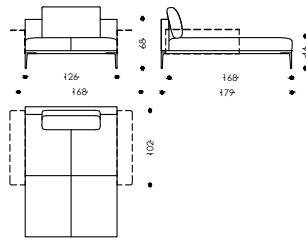

26264

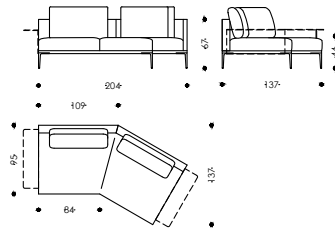

26265

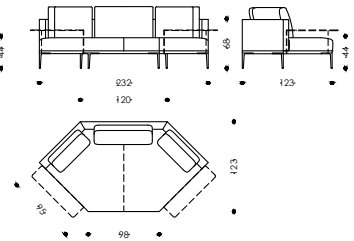

26362

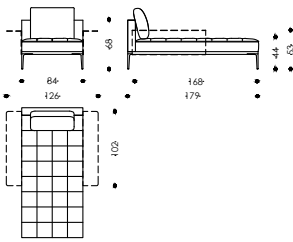

26363

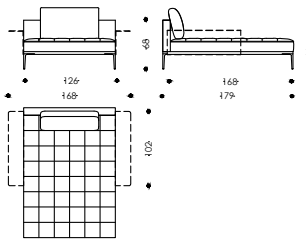

26269

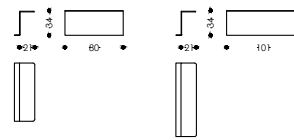

26270

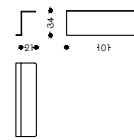

Elements can be combined with leather-covered armrests/ Elemente sind mit lederbezogenen Armteilen kombinierbar

For element groups please attach a drawing to the order/ Bei einer Gruppenbestellung ist unbedingt eine Skizze beizufügen

	26262/ 26362	26263/ 26363	26264	26265	26269	26270
Seat width in cm: Sitzbreite in cm:	84	168	204	232	-	-
Seat width in inches: Sitzbreite in inches:	33,07	66,14	80,32	91,34	-	-
Seat depth in cm: Sitztiefe in cm:	153	58	64	92	-	-
Seat depth in inches: Sitztiefe in inches:	60,24	22,83	25,20	36,22	-	-
WxDxH(SH) in inches:	33,07x70,47x 32,29(17,32)	66,14x70,47x 32,29(17,32)	80,32x53,94x 32,29(17,32)	91,34x36,22x 26,77(17,32)	90,95x37,40x 26,77(17,32)	90,95x37,40x 26,77(17,32)

## Configurations

<b>Frame:</b>	Metal- wooden construction
<b>Legs:</b>	Metal Bronze with leather fiber glides
<b>Surcharge:</b>	Black Grey
<b>Upholstery:</b>	
<b>Seat, Stool cushion:</b>	Fixed webbing, pocket springs and polyurethane foams sandwich layered with dacron overlay
<b>Arm-, Backrest:</b>	Polyurethane foams sandwich layered with dacron overlay
<b>Back Cushion:</b>	100% Feather filling with polyurethane core
<b>Cover:</b>	
<b>Arm-, Backrest:</b>	Fixed cover in leather
<b>Seat (plain):</b>	Fixed cover
<b>Seat (stitched):</b>	Fixed cover with stitched seam, concealed-tacking
<b>Back Cushion:</b>	Removable cover

## Ausführungen

<b>Gestell:</b>	Metall- Holzkonstruktion
<b>Beine:</b>	Metall Bronze mit Lederfasergleitern
<b>Aufpreis:</b>	Metall Black Grey
<b>Polsterung:</b>	
<b>Sitz, Hockerablage:</b>	Starre Begurtung, Taschenfederkern und Polymousse Sandwichaufbau mit Vliesabdeckung
<b>Arm-, Rückenlehne:</b>	Polymousse Sandwichaufbau mit Vliesabdeckung
<b>Lehnkissen:</b>	100% Federnfüllung mit Polymousse Kern
<b>Bezug:</b>	
<b>Arm-, Rückenlehne:</b>	Fixbezug in Leder
<b>Sitz (glatt):</b>	Fixbezug
<b>Sitz (geheftet):</b>	Fixbezug mit Steppnaht, Blindheftung
<b>Lehnkissen:</b>	Bezug abnehmbar

# SALON Recreation Josef Hoffmann\*

19512

19520

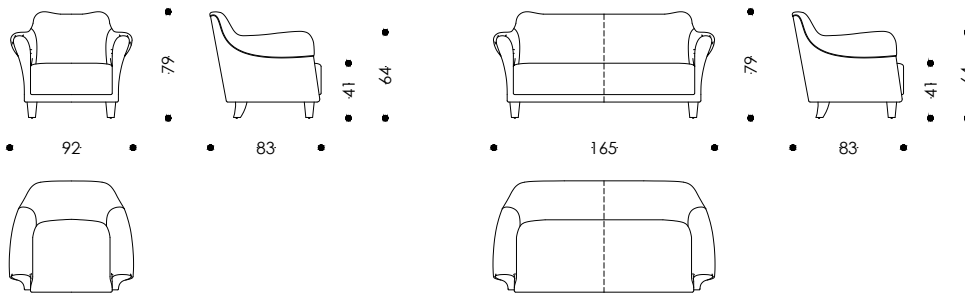

\*after a signed, undated sketch by Josef Hoffmann/ nach einer signierten, undatierten Zeichnung von Josef Hoffmann

Please note that this product will be individually produced and the delivery time has to be requested/  
Bitte beachten Sie, dass dieses Modell in Einzelanfertigung hergestellt wird, daher ist die Lieferzeit vor Auftrag anzufagen

	19512	19520
Seat width in cm: <i>Sitzbreite in cm:</i>	58	131
Seat width in inches: <i>Sitzbreite in inches:</i>	22,83	51,58
Seat depth in cm: <i>Sitztiefe in cm:</i>	54	54
Seat depth in inches: <i>Sitztiefe in inches:</i>	21,26	21,26
WxDxH(SH) in inches:	36,22x32,68x31,10(16,14)	64,96x32,68x31,10(16,14)

## Configurations

<b>Frame:</b>	Wooden construction
<b>Legs:</b>	Beech solid Black with felt glides
<b>Upholstery:</b>	
<b>Seat:</b>	Fixed webbing, coil springs with jute overlay, polyurethane foams sandwich layered with dacron overlay
<b>Arm-, Backrest:</b>	Elastic webbing, polyurethane foams sandwich layered with dacron overlay
<b>Cover:</b>	Fixed cover with piping
<b>Piping:</b>	Same as cover

## Ausführungen

<b>Gestell:</b>	Holzkonstruktion
<b>Beine:</b>	Buche massiv Schwarz mit Filzgleitern
<b>Polsterung:</b>	
<b>Sitz:</b>	Starre Begurtung, Federkern mit Juteabdeckung, Polymousse Sandwichaufbau mit Vliesabdeckung
<b>Arm-, Rückenlehne:</b>	Elastische Begurtung, Polymousse Sandwichaufbau mit Vliesabdeckung
<b>Bezug:</b>	Fixbezug mit Keder
<b>Keder:</b>	Wie Bezug



# SITZMASCHINE Recreation Josef Hoffmann (Design: 1905)

93012

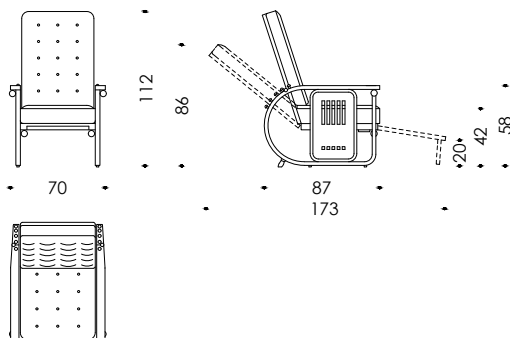

*\*after a signed, undated sketch by Josef Hoffmann/ nach einer signierten, undatierten Zeichnung von Josef Hoffmann*

Please note that this product will be individually produced and the delivery time has to be requested/  
*Bitte beachten Sie, dass dieses Modell in Einzelanfertigung hergestellt wird, daher ist die Lieferzeit vor Auftrag anzufragen*

No TSCA Title VI Standard - Delivery to the USA is therefore not possible/  
*Keine TSCA Title VI Norm - daher keine Lieferung in die USA möglich*

93012	
Seat width in cm: <i>Sitzbreite in cm:</i>	50
Seat width in inches: <i>Sitzbreite in inches:</i>	19,68
Seat depth in cm: <i>Sitztiefe in cm:</i>	51/ 60
Seat depth in inches: <i>Sitztiefe in inches:</i>	20,08/ 23,62
WxDxH(SH) in inches:	27,56x34,25x44,09(16,54)

## Configurations

<b>Frame:</b>	Beech solid Black with brass screws
<b>Upholstery:</b>	
Seat:	Polyurethane foams with dacron overlay
Backrest:	Polyurethane foams and latex with dacron overlay
<b>Cover:</b>	Fixed cover with piping and upholstered buttons, fastening loop with press button
<b>Piping, Buttons:</b>	Same as cover

## Ausführungen

<b>Gestell:</b>	Buche massiv Schwarz mit Messingschrauben
<b>Polsterung:</b>	
Sitzteil:	Polymousse mit Vliesabdeckung
Lehnteil:	Polymousse und Latex mit Vliesabdeckung
<b>Bezug:</b>	Fixbezug mit Keder und gepolsterten Zierknöpfen, Halterungsschlaufe mit Druckknopf
<b>Keder, Zierknöpfe:</b>	Wie Bezug

# VILLA GALLIA Recreation Josef Hoffmann (Design: 1913)

8712

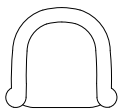
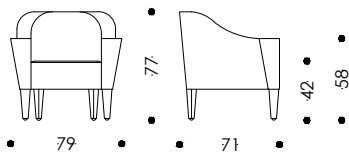

8720

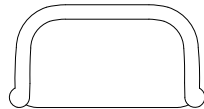
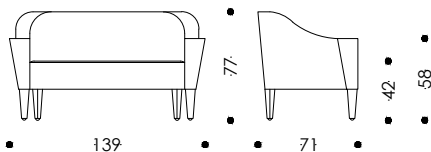

	8712	8720
<b>Seat width in cm:</b> <i>Sitzbreite in cm:</i>	50	110
<b>Seat width in inches:</b> <i>Sitzbreite in inches:</i>	19,69	43,31
<b>Seat depth in cm:</b> <i>Sitztiefe in cm:</i>	53	53
<b>Seat depth in inches:</b> <i>Sitztiefe in inches:</i>	20,87	20,87
<b>WxDxH(SH) in inches:</b>	36,61x32,28x36,22(16,14)	62,20x32,28x36,22(16,14)

## Configurations

<b>Frame:</b>	Wooden construction
<b>Legs:</b>	Beech solid Black with felt glides
<b>Upholstery:</b>	
<b>Seat:</b>	Elastic webbing, Polyurethane foams and Latex sandwich layered with dacron overlay
<b>Arm-/Backrest:</b>	Elastic webbing, polyurethane foams sandwich layered with dacron overlay
<b>Cover:</b>	Fixed cover with piping or braid
<b>Piping:</b>	Same as cover
<b>Without surcharge:</b>	Leather in standard colours Color Atlantic, Black, Cognac, Dark grey, Mocca, Sand, Siena and Taupe
<b>Braid:</b>	Black
<b>Without surcharge:</b>	Black&White
<b>Surcharge:</b>	Matching the fabric (single-/ two-tone)

## Ausführungen

<b>Gestell:</b>	Holzkonstruktion
<b>Beine:</b>	Buche massiv Schwarz mit Filzgleitern
<b>Polsterung:</b>	
<b>Sitz:</b>	Elastische Begurtung, Polymousse und Latex Sandwichaufbau mit Vliesabdeckung
<b>Arm-/Rückenlehne:</b>	Elastische Begurtung, Polymousse Sandwichaufbau mit Vliesabdeckung
<b>Bezug:</b>	Fixbezug mit Keder oder Borte
<b>Keder:</b>	wie Bezug
<b>Auf Wunsch:</b>	Leder in Standardfarben Color Atlantic, Black, Cognac, Dark grey, Mocca, Sand, Siena und Taupe
<b>Borte:</b>	Schwarz
<b>Auf Wunsch:</b>	Schwarz&Weiß
<b>Aufpreis:</b>	passend zum Stoff (ein-/ zweifärbig)

<b>Cover in Streif 4:</b>	Fixed cover with piping or braid
<b>Piping:</b>	Streif 4 fabric uni-black or uni-white without surcharge
<b>Braid:</b>	Black or Black&White without surcharge

<b>Bezug in Streif 4:</b>	Fixbezug mit Keder oder Borte
<b>Keder:</b>	Streif 4 Stoff Uni-Schwarz oder Uni-Weiß auf Wunsch
<b>Borte:</b>	Schwarz oder Schwarz&Weiß auf Wunsch

# VUELTA Design: Jaime Hayon

25712

25717

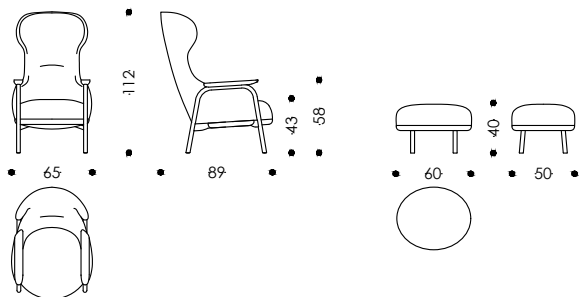

25701

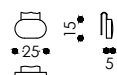

	25712	25717	25701
<b>Seat width in cm:</b> <b>Sitzbreite in cm:</b>	51	60	-
<b>Seat width in inches:</b> <b>Sitzbreite in inches:</b>	20,08	23,62	-
<b>Seat depth in cm:</b> <b>Sitztiefe in cm:</b>	56	50	-
<b>Seat depth in inches:</b> <b>Sitztiefe in inches:</b>	22,05	19,69	-
<b>WxDxH(SH) in inches:</b>	25,59x35,04x44,09(16,93)	23,62x19,69x15,75	9,84x1,97x5,91

## Configurations

<b>Frame:</b>	Metal- wooden construction
<b>Legs:</b>	Beech solid Black with felt glides
<b>Surcharge:</b>	Beech solid stained to walnut
<b>Armrest:</b>	Beech solid Black (legs black-coloured)
<b>Surcharge:</b>	Walnut solid (legs walnut-coloured)
<b>Upholstery:</b>	
<b>Seat:</b>	Fixed webbing, Pocket springs and Polyurethane foams sandwich layered with dacron overlay
<b>Shell:</b>	Polyurethane foams sandwich layered with dacron overlay
<b>Cover:</b>	Fixed cover

## Ausführungen

<b>Gestell:</b>	<i>Metall- Holzkonstruktion</i>
<b>Beine:</b>	<i>Buche massiv Schwarz mit Filzgleitern</i>
<b>Surcharge:</b>	<i>Buche massiv zu Nuss gebeizt</i>
<b>Armteil:</b>	<i>Buche massiv Schwarz (Beine schwarzfärbig)</i>
<b>Surcharge:</b>	<i>Nuss massiv (Beine nussfärbig)</i>
<b>Polsterung:</b>	
<b>Sitz:</b>	<i>Starre Begurtung, Taschenfederkern und Polymousse Sandwichaufbau mit Vliesabdeckung</i>
<b>Schale:</b>	<i>Polymousse Sandwichaufbau mit Vliesabdeckung</i>
<b>Bezug:</b>	<i>Fixbezug</i>

# VUELTA Design: Jaime Hayon

25612

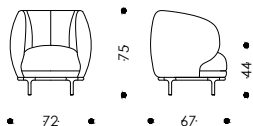

25613

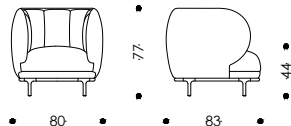

25612D

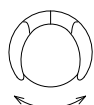
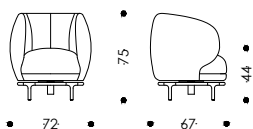

360° swivel with automatic return  
360° drehbar mit Rückholautomatik

25613D

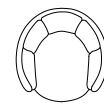
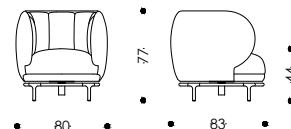

360° swivel with automatic return  
360° drehbar mit Rückholautomatik

	25612/ 25612D	25613/ 25613D
<b>Seat width in cm:</b> <b>Sitzbreite in cm:</b>	45	55
<b>Seat width in inches:</b> <b>Sitzbreite in inches:</b>	17,72	21,65
<b>Seat depth in cm:</b> <b>Sitztiefe in cm:</b>	51	56
<b>Seat depth in inches:</b> <b>Sitztiefe in inches:</b>	20,08	22,05
<b>WxDxH(SH) in inches:</b>	28,35x26,38x29,53(17,32)	31,50x32,28x30,31(17,32)

## Configurations

### Frame:

25612, 25612D: Metal- wooden construction

25613, 25613D: Wooden construction

**Legs:** Metal Bronze with leather fiber glides

**Surcharge:** Black Grey, Chrome, Black Chrome or 24k Gold plated

**Seat height:** 44cm

**Surcharge:** Legs height -2cm, +3cm, +4cm or +5cm

### Upholstery:

**Seat:** Fixed webbing, coil springs with jute overlay and polyurethane foams sandwich layered with dacron overlay

**Shell:** high-resilient polyurethane foams with polyurethane pads and dacron overlay

**Cover:** Fixed cover

## Ausführungen

### Gestell:

25612, 25612D: Metall- Holzkonstruktion

25613, 25613D: Holzkonstruktion

**Beine:** Metall Bronze mit Lederfasergleitern

**Surcharge:** Black Grey, Chrom, Schwarzchrom oder 24k vergoldet

**Sitzhöhe:** 44cm

**Surcharge:** Beinhöhe -2cm, +3cm, +4cm oder +5cm

### Polsterung:

**Sitz:** Starre Begurtung, Federkern mit Juteabdeckung und Polymousse Sandwichaufbau mit Vliesabdeckung

**Schale:** Hoch belastbarer Polymousse mit Polymousse-Auflage und Vliesabdeckung

**Bezug:** Fixbezug

# VUELTA Design: Jaime Hayon

25618

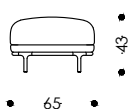

25640

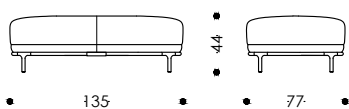

25641

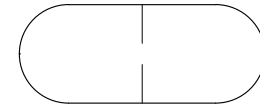
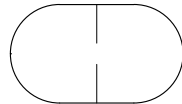
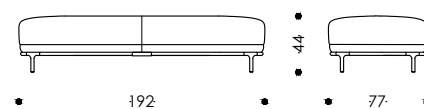

25642

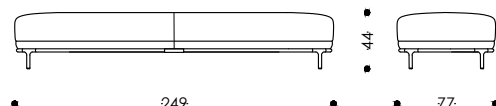

25643

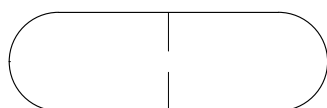
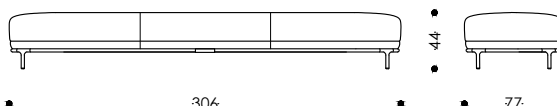

	25618	25640	25641	25642	25643
<b>Seat width in cm:</b> <b>Sitzbreite in cm:</b>	Ø65	135	192	249	306
<b>Seat width in inches:</b> <b>Sitzbreite in inches:</b>	Ø25,59	53,15	75,59	90,09	120,47
<b>Seat depth in cm:</b> <b>Sitztiefe in cm:</b>	Ø65	77	77	77	77
<b>Seat depth in inches:</b> <b>Sitztiefe in inches:</b>	Ø25,59	30,31	30,31	30,31	30,31
<b>WxDxH(SH) in inches:</b>	Ø25,59x16,93	53,15x30,31x17,32	75,59x30,31x17,32	90,09x30,31x17,32	120,47x30,31x17,32

## Configurations

<b>Frame:</b>	Wooden construction
<b>Legs:</b>	Metal Bronze with leather fiber glides
<b>Surcharge:</b>	Black Grey, Chrome, Black Chrome or 24k Gold plated
<b>Seat height:</b>	44cm
<b>Surcharge:</b>	Legs height -2cm, +3cm, +4cm or +5cm
<b>Upholstery:</b>	Polyurethane foams sandwich layered with dacron overlay
<b>Cover:</b>	Fixed cover

## Ausführungen

<b>Gestell:</b>	Holzkonstruktion
<b>Beine:</b>	Metall Bronze mit Lederfasergleitern
<b>Surcharge:</b>	Black Grey, Chrom, Schwarzchrom oder 24k vergoldet
<b>Sitzhöhe:</b>	44cm
<b>Surcharge:</b>	Beinhöhe -2cm, +3cm, +4cm oder +5cm
<b>Polsterung:</b>	Polymousse Sandwichaufbau mit Vliesabdeckung
<b>Bezug:</b>	Fixbezug

# VUELTA

Design: Jaime Hayon

25615

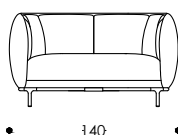

77

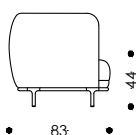

44

140

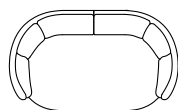

25620

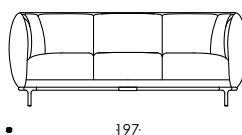

77

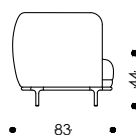

44

197

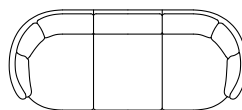

25625

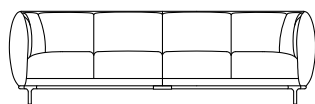

77

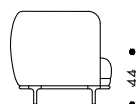

44

254

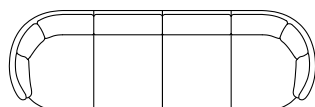

25630

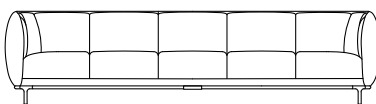

77

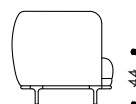

44

311

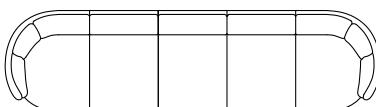

	25615	25620	25625	25630
<b>Seat width in cm:</b> <i>Sitzbreite in cm:</i>	85	142	199	256
<b>Seat width in inches:</b> <i>Sitzbreite in inches:</i>	33,46	55,91	78,35	100,79
<b>Seat depth in cm:</b> <i>Sitztiefe in cm:</i>	59	59	59	59
<b>Seat depth in inches:</b> <i>Sitztiefe in inches:</i>	23,23	23,23	23,23	23,23
<b>WxDxH(SH) in inches:</b>	55,12x32,68x30,31(17,32)	77,56x32,68x30,31(17,32)	100,00x32,68x30,31(17,32)	122,44x32,68x30,31(17,32)

## Configurations

<b>Frame:</b>	Metal- wooden construction
<b>Legs:</b>	Metal Bronze with leather fiber glides
<b>Surcharge:</b>	Black Grey, Chrome, Black Chrome or 24k Gold plated
<b>Seat height:</b>	44cm
<b>Surcharge:</b>	Legs height -2cm, +3cm, +4cm or +5cm
<b>Upholstery:</b>	
<b>Seat:</b>	Fixed webbing, coil springs with jute overlay and polyurethane foams sandwich layered with dacron overlay
<b>Shell:</b>	Polyurethane foams sandwich layered with dacron overlay
<b>Cover:</b>	Fixed cover

## Ausführungen

<b>Gestell:</b>	Metall- Holzkonstruktion
<b>Beine:</b>	Metall Bronze mit Lederfasergleitern
<b>Surcharge:</b>	Black Grey, Chrom, Schwarzchrom oder 24k vergoldet
<b>Sitzhöhe:</b>	44cm
<b>Surcharge:</b>	Beinhöhe -2cm, +3cm, +4cm oder +5cm
<b>Polsterung:</b>	
<b>Sitz:</b>	Starre Begurtung, Federkern mit Juteabdeckung und Polymousse Sandwichaufbau mit Vliesabdeckung
<b>Schale:</b>	Polymousse Sandwichaufbau mit Vliesabdeckung
<b>Bezug:</b>	Fixbezug

# VUELTA Design: Jaime Hayon

25636(R)/ 25632(L)

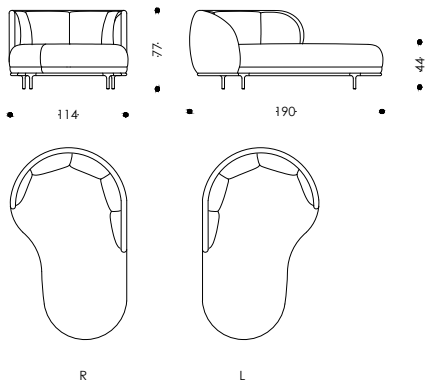

25637(R)/ 25634(L)

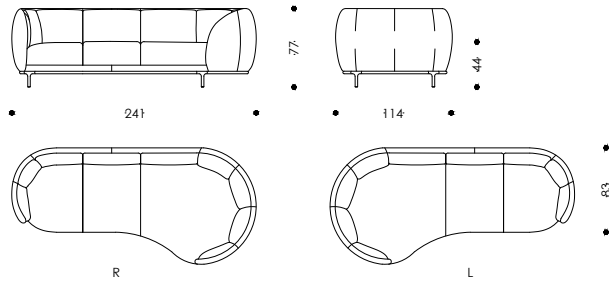

25638(R)/ 25635(L)

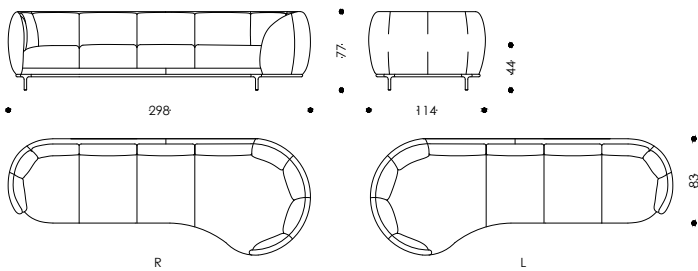

25633

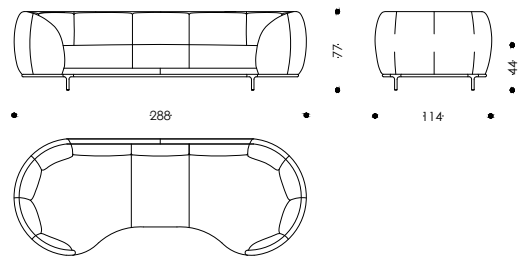

	25636/ 25632	25637/ 25634	25638/ 25635	25633
<b>Seat width in cm:</b> <i>Sitzbreite in cm:</i>	93	197	254	237
<b>Seat width in inches:</b> <i>Sitzbreite in inches:</i>	36,61	77,56	100,00	93,31
<b>Seat depth in cm:</b> <i>Sitztiefe in cm:</i>	170	70/ 94	70/ 94	70/ 94
<b>Seat depth in inches:</b> <i>Sitztiefe in inches:</i>	66,93	27,56/ 37,01	27,56/ 37,01	27,56/37,01
<b>WxDxH(SH) in inches:</b>	78,70x44,88x30,31(17,32)	94,98x44,88x30,31(17,32)	117,32x44,88x30,31(17,32)	113,39x44,88x30,31(17,32)

## Configurations

<b>Frame:</b>	Metal- wooden construction
<b>Legs:</b>	Metal Bronze with leather fiber glides
<b>Surcharge:</b>	Black Grey, Chrome, Black Chrome or 24k Gold plated
<b>Seat height:</b>	44cm
<b>Surcharge:</b>	Legs height -2cm, +3cm, +4cm or +5cm
<b>Upholstery:</b>	
<b>Seat:</b>	Fixed webbing, coil springs with jute overlay and polyurethane foams sandwich layered with dacron overlay
<b>Shell:</b>	Polyurethane foams sandwich layered with dacron overlay
<b>Cover:</b>	Fixed cover

## Ausführungen

<b>Gestell:</b>	Metall- Holzkonstruktion
<b>Beine:</b>	Metall Bronze mit Lederfasergleitern
<b>Surcharge:</b>	Black Grey, Chrom, Schwarzchrom oder 24k vergoldet
<b>Sitzhöhe:</b>	44cm
<b>Surcharge:</b>	Beinhöhe -2cm, +3cm, +4cm oder +5cm
<b>Polsterung:</b>	
<b>Sitz:</b>	Starre Begurtung, Federkern mit Juteabdeckung und Polymousse Sandwichaufbau mit Vliesabdeckung
<b>Schale:</b>	Polymousse Sandwichaufbau mit Vliesabdeckung
<b>Bezug:</b>	Fixbezug

# VUELTA

Design: Jaime Hayon

25601

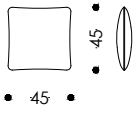

25602

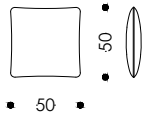

	25601	25602
<b>WxDxH in cm:</b>	45x45	50x50
<b>BxTxH in cm:</b>		
<b>WxDxH in inches:</b>	17,72x17,72	19,67x19,67

## Configurations

<b>Upholstery:</b>	Feather filling with foam flakes
<b>Cover:</b>	Fixed cover with piping
<b>Piping:</b>	Same as cover

## Ausführungen

<b>Polsterung:</b>	Federnfüllung mit Schaumstofflocken
<b>Bezug:</b>	Fixbezug mit Keder
<b>Keder:</b>	Wie Bezug



# VUELTA Design: Jaime Hayon

## Combination Examples/ Kombinationsbeispiele

Combination Example 1/ Kombinationsbeispiel 1

- 1x End Element L/ Abschlusselement L (27701)
- 1x End Element R/ Abschlusselement R (27702)

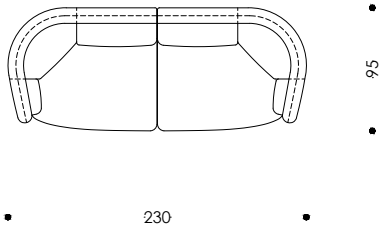

Kombinationsbeispiel 2/ Combination Example 2

- 1x End Element L/ Abschlusselement L (27701)
- 2x Middle Element curved/ Zwischenelement gebogen (27704)
- 1x End Element R/ Abschlusselement R (27702)

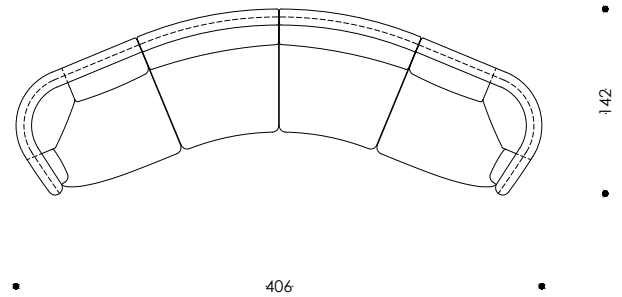

Combination Example 3/ Kombinationsbeispiel 3

- 1x Chaise Longue L/ Chaiselongue L (27705)
- 1x Middle Element/ Zwischenelement (27703)
- 1x End Element R/ Abschlusselement R (27702)

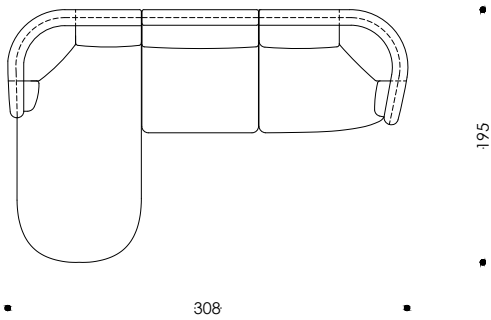

Combination Example 4/ Kombinationsbeispiel 4

- 1x End Element L/ Abschlusselement L (27701)
- 1x End Element R/ Abschlusselement R (27702)
- 2x Corner Element/ Eckelement (27707)
- 5x Middle Element/ Zwischenelement (27703)

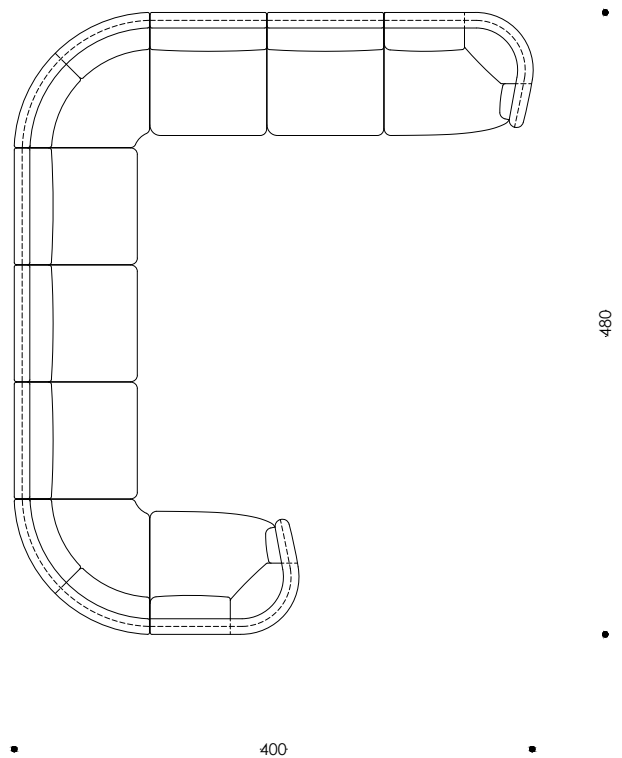

Combination Example 5/ Kombinationsbeispiel 5

- 1x End Element L/ Abschlusselement L (27701)
- 1x Corner Element/ Eckelement (27707)
- 1x Middle Element/ Zwischenelement (27703)
- 1x End Element R/ Abschlusselement R (27702)

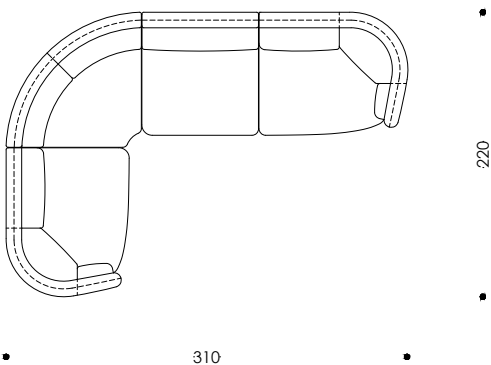

# VUELTA Design: Jaime Hayon

## Combination Examples/ Kombinationsbeispiele

Combination Example 6/ Kombinationsbeispiel 6

- 1x End Element L/ Abschlusselement L (27701)
- 1x Middle Table Element/ Zwischentischelement (27790)
- 1x End Element R/ Abschlusselement R (27702)

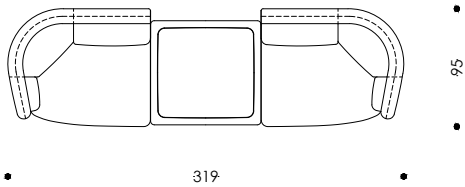

Combination Example 7/ Kombinationsbeispiel 7

- 1x End Element L/ Abschlusselement L (27701)
- 1x Corner Element/ Eckelement (27707)
- 2x Middle Element/ Zwischenelement (27703)
- 1x Corner Table Element/ Ecktischelement (27791)
- 1x End Element R/ Abschlusselement R (27702)

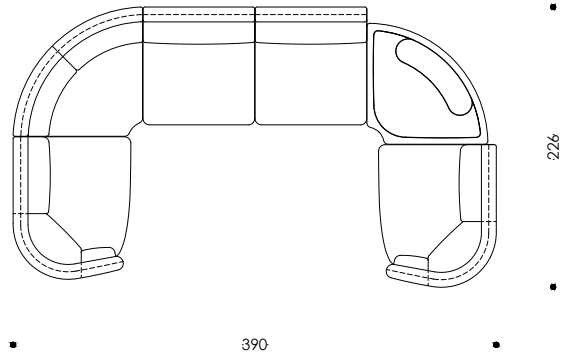

Combination Example 8/ Kombinationsbeispiel 8

- 1x End Element L/ Abschlusselement L (27701)
- 1x Middle Element/ Zwischenelement (27703)
- 1x Middle Table Element/ Zwischentischelement (27790)
- 1x Chaise Longue R/ Chaiselongue R (27706)

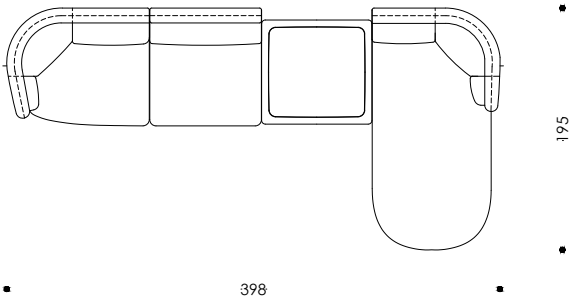

Combination Example 9/ Kombinationsbeispiel 9

- 1x End Element L/ Abschlusselement L (27701)
- 1x Middle Table Element/ Zwischentischelement (27790)
- 1x Corner Element/ Eckelement (27707)
- 2x Middle Element/ Zwischenelement (27703)
- 1x Corner Table Element/ Ecktischelement (27791)
- 1x End Element R/ Abschlusselement R (27702)

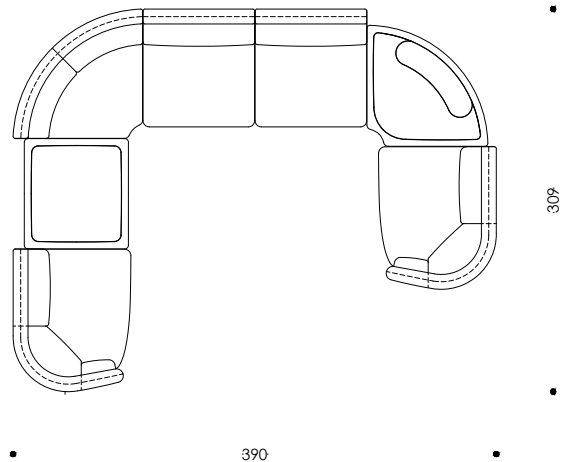

Combination Example 10/ Kombinationsbeispiel 10

- 1x End Element L/ Abschlusselement L (27701)
- 2x Middle Element/ Zwischenelement (27703)
- 1x Corner Table Element/ Ecktischelement (27791)
- 1x End Element R/ Abschlusselement R (27702)

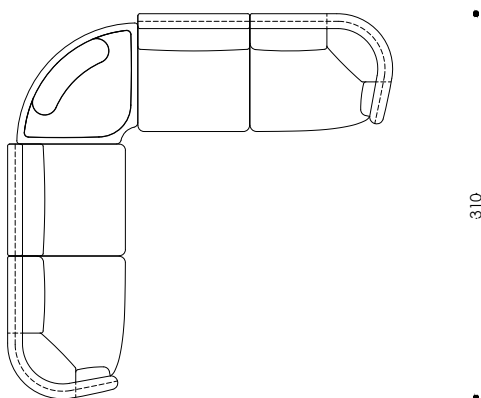

# VUELTA Design: Jaime Hayon

27702(R)/ 27701(L)

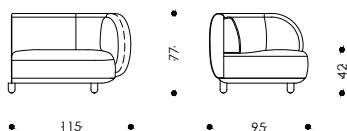

27706(R)/ 27705(L)

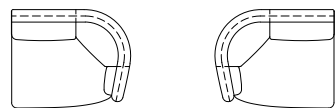
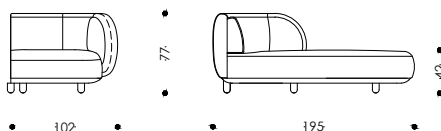

R

L

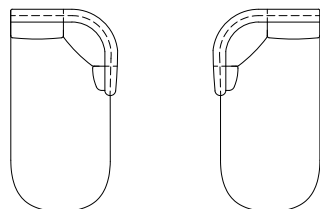

R

L

Configuration/ Konfiguration

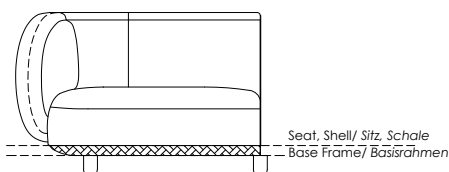

Seat, Shell/ Sitz, Schale  
Base Frame/ Basisrahmen

Base frame can be executed in different coloured leather/  
Basisrahmen kann in andersfarbigem Leder ausgeführt werden

Elements are not free-standing. Feet are used as element connectors/  
Die Elemente sind nicht freistehend. Die Füße fungieren als Elementverbinder

For element groups please attach a drawing to the order/ Bei einer Gruppenbestellung ist unbedingt eine Skizze beizufügen

	27702/ 27701	27706/ 27705
<b>Seat width in cm:</b> <b>Sitzbreite in cm:</b>	90	96
<b>Seat width in inches:</b> <b>Sitzbreite in inches:</b>	35,43	37,80
<b>Seat depth in cm:</b> <b>Sitztiefe in cm:</b>	65	160
<b>Seat depth in inches:</b> <b>Sitztiefe in inches:</b>	25,59	62,99
<b>WxDxH(SH) in inches:</b>	44,09x37,40x29,13(16,54)	40,55x75,20x29,13(16,54)

## Configurations

<b>Frame:</b>	Wooden construction
<b>Legs:</b>	Beech solid Black with height-adjustable felt glides
<b>Upholstery:</b>	
<b>Seat:</b>	Pocket springs, polyurethane foams sandwich layered with dacron overlay
<b>Backrest, Shell:</b>	Polyurethane foams sandwich layered with dacron overlay
<b>Cover:</b>	Fixed cover
<b>unicolour:</b>	Base Frame same as cover
<b>multicolour:</b>	Base Frame in different coloured leather

## Ausführungen

<b>Gestell:</b>	Holzkonstruktion
<b>Beine:</b>	Buche massiv Schwarz mit höhenverstellbaren Filzgleitern
<b>Polsterung:</b>	
<b>Sitz:</b>	Taschenfederkern, Polymousse Sandwichaufbau mit Vliesabdeckung
<b>Lehne, Schale:</b>	Polymousse Sandwichaufbau mit Vliesabdeckung
<b>Bezug:</b>	Fixbezug
<b>einfärbig:</b>	Basisrahmen wie Bezug
<b>mehrfärbig:</b>	Basisrahmen in andersfarbigem Leder

# VUELTA Design: Jaime Hayon

27703

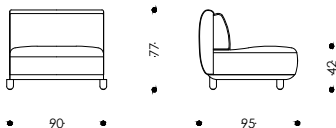

27704

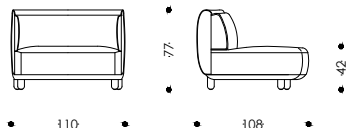

27707

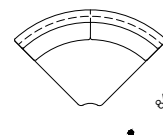
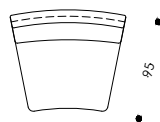
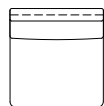
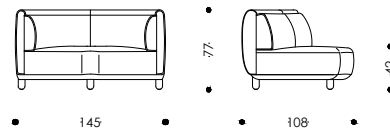

Configuration/ Konfiguration

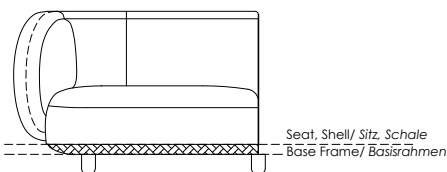

Base frame can be executed in different coloured leather/  
Basisrahmen kann in andersfarbigem Leder ausgeführt werden

Elements are not free-standing. Feet are used as element connectors/  
Die Elemente sind nicht freistehend. Die Füße fungieren als Elementverbinder

For element groups please attach a drawing to the order/ Bei einer Gruppenbestellung ist unbedingt eine Skizze beizufügen

These elements can not be used as end elements/ Diese Elemente können nicht als Abschluss verwendet werden

	27703	27704	27707
<b>Seat width in cm:</b> <b>Sitzbreite in cm:</b>	90	100	108
<b>Seat width in inches:</b> <b>Sitzbreite in inches:</b>	35,43	39,37	42,52
<b>Seat depth in cm:</b> <b>Sitztiefe in cm:</b>	65	65	65
<b>Seat depth in inches:</b> <b>Sitztiefe in inches:</b>	25,59	25,59	25,59
<b>WxDxH(SH) in inches:</b>	35,43x37,40x29,13(16,54)	43,70x42,52x29,13(16,54)	60,24x42,52x29,13(16,54)

## Configurations

<b>Frame:</b>	Wooden construction
<b>Legs:</b>	Beech solid Black with height-adjustable felt glides
<b>Upholstery:</b>	
<b>Seat:</b>	Pocket springs, polyurethane foams sandwich layered with dacron overlay
<b>Backrest, Shell:</b>	Polyurethane foams sandwich layered with dacron overlay
<b>Cover:</b>	Fixed cover
<b>unicolour:</b>	Base Frame same as cover
<b>multicolour:</b>	Base Frame in different coloured leather

## Ausführungen

<b>Gestell:</b>	Holzkonstruktion
<b>Beine:</b>	Buche massiv Schwarz mit höhenverstellbaren Filzgleitern
<b>Polsterung:</b>	
<b>Sitz:</b>	Taschenfederkern, Polymousse Sandwichaufbau mit Vliesabdeckung
<b>Lehne, Schale:</b>	Polymousse Sandwichaufbau mit Vliesabdeckung
<b>Bezug:</b>	Fixbezug
<b>einfärbig:</b>	Basisrahmen wie Bezug
<b>mehrfärbig:</b>	Basisrahmen in andersfarbigem Leder

# VUELTA Design: Jaime Hayon

27790

27791

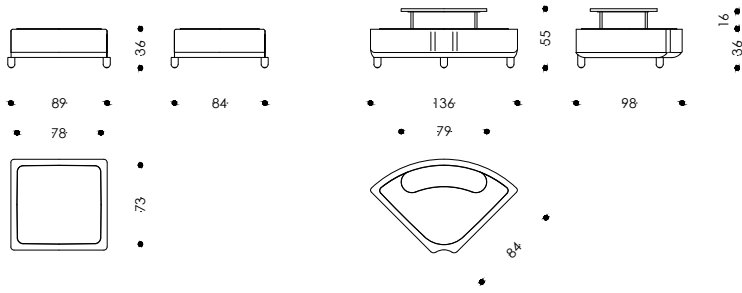

For element groups please attach a drawing to the order/ *Bei einer Gruppenbestellung ist unbedingt eine Skizze beizufügen*

Elements are not free-standing. Feet are used as element connectors/

*Die Elemente sind nicht freistehend. Die Füße fungieren als Elementverbinder*

These elements can not be used as end elements/ *Diese Elemente können nicht als Abschluss verwendet werden*

	27790	27791
<b>WxDxH (leg room) in cm:</b>	89x84x36	50x10x50
<b>BxTxH (Beinfreiheit) in cm:</b>		
<b>WxDxH (leg room) in inches:</b>	35,04x33,07x14,17	53,54x38,58x21,65

## Configurations

<b>Frame:</b>	Wooden construction with dacron overlay
<b>Columns (27791):</b>	Metal Black Grey
<b>Legs:</b>	Beech solid Black with height-adjustable felt glides
<b>Cover:</b>	Fixed cover
<b>unicolour:</b>	Base same as cover
<b>multicolour:</b>	Base in different coloured leather
<b>Tabletop:</b>	Leather covered in Nappa
<b>Surcharge:</b>	Marble Carrara White Corner Table Element: tabletops always unicolour

## Ausführungen

<b>Gestell:</b>	Holzkonstruktion mit Vliesabdeckung
<b>Säule (27791):</b>	Metall Black Grey
<b>Beine:</b>	Buche massiv Schwarz mit höhenverstellbaren Filzgleitern
<b>Bezug:</b>	Fixbezug
<b>einfärbig:</b>	Basis wie Bezug
<b>mehrfärbig:</b>	Basis in andersfärbigen Leder
<b>Tischplatte:</b>	Lederbezogen in Nappa
<b>Aufpreis:</b>	Marmor Carrara White Ecktschelement: Tischplatten immer einfärbig

# BERLIN

Design: Kai Stania, Christian Horner

17883

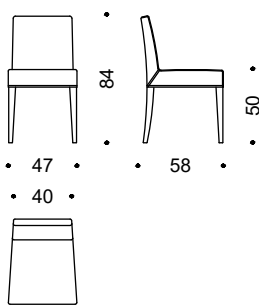

17863

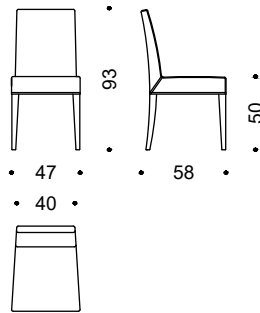

17884

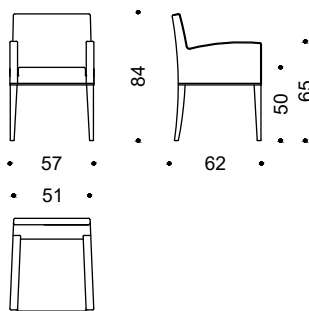

17864

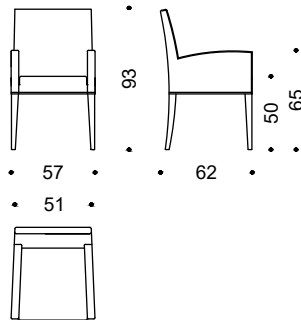

	17883	17863	17884	17864
<b>Seat width in cm:</b> <i>Sitzbreite in cm:</i>	45	45	45	45
<b>Seat width in inches:</b> <i>Sitzbreite in inches:</i>	17,72	17,72	17,72	17,72
<b>Seat depth in cm:</b> <i>Sitztiefe in cm:</i>	44	44	47	47
<b>Seat depth in inches:</b> <i>Sitztiefe in inches:</i>	17,42	17,42	18,50	18,50
<b>WxDxH(SH) in inches:</b>	18,50x22,83x33,07(19,69)	18,50x22,83x36,61(19,69)	22,44x24,41x33,07(19,69)	22,44x24,41x36,61(19,69)

## Configurations

<b>Frame:</b>	Metal- wooden construction
<b>Legs:</b>	Beech solid Black with Teflon glides
<b>Surcharge:</b>	In Wittmann standard RAL colours, Oak solid or Walnut solid
<b>Upholstery:</b>	
<b>Seat:</b>	Fixed webbing with pocket springs and polyurethane foams with dacron overlay
<b>Arm-, Backrest:</b>	polyurethane foams with dacron overlay
<b>Cover:</b>	Fixed cover
<b>Surcharge:</b>	Removable cover (fabric only)

## Ausführungen

<b>Gestell:</b>	<i>Metall- Holzkonstruktion</i>
<b>Beine:</b>	<i>Buche massiv Schwarz mit Teflongleitern</i>
<b>Aufpreis:</b>	<i>In Wittmann Standard RAL Farben, Eiche massiv oder Nuss massiv</i>
<b>Polsterung:</b>	
<b>Sitz, Rückenlehne:</b>	<i>Starre Begurtung, Taschenfederkern und Polymousse mit Vliesabdeckung</i>
<b>Arm-, Rückenlehne:</b>	<i>Polymousse mit Vliesabdeckung</i>
<b>Bezug:</b>	<i>Fixbezug</i>
<b>Aufpreis:</b>	<i>Bezug abnehmbar (Nur Stoff)</i>

# CARINZIA

Design: LucidiPevere

28163

28165

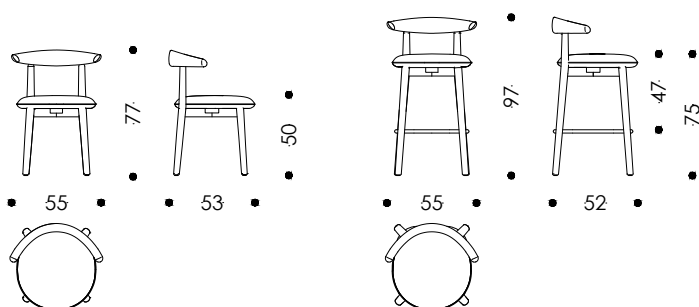

	28163	28165
Seat width in cm: <i>Sitzbreite in cm:</i>	Ø50	Ø50
Seat width in inches: <i>Sitzbreite in inches:</i>	Ø19,69	Ø19,69
Seat depth in cm: <i>Sitztiefe in cm:</i>	Ø50	Ø50
Seat depth in inches: <i>Sitztiefe in inches:</i>	Ø19,69	Ø19,69
WxDxH(SH) in inches:	21,65x20,87x30,31(19,69)	21,65x20,87x38,19(29,53)

## Configurations

<b>Frame:</b>	Ash solid Black with Teflon glides
<b>Surcharge:</b>	in Wittmann standard RAL colours
<b>Foot Ring: (Barstool)</b>	Metal Black Grey
<b>Upholstery:</b>	Pocket springs and polyurethane foams sandwich layered with dacron overlay
<b>Cover:</b>	Fixed cover with piping
<b>Piping:</b>	Same as cover

## Ausführungen

<b>Gestell:</b>	Esche massiv Schwarz mit Teflongleitern
<b>Aufpreis:</b>	In Wittmann Standard RAL Farben
<b>Fußring: (Barstuhl)</b>	Metall Black Grey
<b>Polsterung:</b>	Taschenfederkern und Polymousse Sandwichaufbau mit Vliesabdeckung
<b>Bezug:</b>	Fixbezug mit Keder
<b>Keder:</b>	Wie Bezug

# FAME Design: Christophe Pillet

22364

Figure with armrest cushions/  
Abbildung mit Armteilkissen

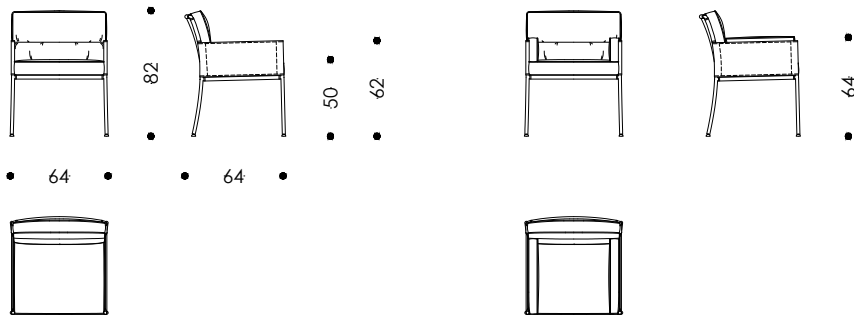

## Armrest cushions mountable afterwards/ Armteilkissen nachträglich montierbar

22364	
Seat width in cm: <i>Sitzbreite in cm:</i>	58 (45)
Seat width in inches: <i>Sitzbreite in inches:</i>	22,83 (17,72)
Seat depth in cm: <i>Sitztiefe in cm:</i>	45
Seat depth in inches: <i>Sitztiefe in inches:</i>	17,72
WxDxH(SH) in inches:	25,20x25,20x32,28(19,69)

### Configurations

<b>Frame:</b>	Metal Black Grey with belted frame and felt glides
<b>Surcharge:</b>	Bronze
<b>Shell:</b>	Saddle leather colour Black
<b>Without surcharge:</b>	Saddle leather colour Sand
<b>Upholstery:</b>	
<b>Seat cushion:</b>	Loose cushion with pocket springs, polyurethane foams sandwich layered with dacron overlay
<b>Back cushion:</b>	Mounted on the frame, polyurethane foams sandwich layered with dacron overlay
<b>Armrest cushion: (additional)</b>	2x loose cushions attachable with velcro, polyurethane foams sandwich layered with dacron overlay
<b>Cover:</b>	Fixed cover with piping
<b>Piping:</b>	Same as cover

### Ausführungen

<b>Gestell:</b>	Metall Black Grey mit begurtetem Rahmen und Filzgleitern
<b>Aufpreis:</b>	Bronze
<b>Schale:</b>	Kernleder Farbe Schwarz
<b>Auf Wunsch:</b>	Kernleder Farbe Sand
<b>Polsterung:</b>	
<b>Sitzkissen:</b>	Loses Kissen mit Taschenfederkern, Polymousse Sandwichaufbau mit Vliesabdeckung
<b>Lehnkissen:</b>	montiert am Gestell, Polymousse Sandwichaufbau mit Vliesabdeckung
<b>Armteilkissen: (zusätzlich)</b>	2x lose Kissen mit Klettband fixierbar, Polymousse Sandwichaufbau mit Vliesabdeckung
<b>Bezug:</b>	Fixbezug mit Keder
<b>Keder:</b>	Wie Bezug



# FLEDERMAUS

Recreation Josef Hoffmann (Design: 1907)

8412

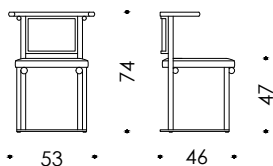

Please note that this product will be individually produced and the delivery time has to be requested/  
Bitte beachten Sie, dass dieses Modell in Einzelanfertigung hergestellt wird, daher ist die Lieferzeit vor Auftrag anzufagen

	8412
Seat width in cm: <i>Sitzbreite in cm:</i>	53
Seat width in inches: <i>Sitzbreite in inches:</i>	20,87
Seat depth in cm: <i>Sitztiefe in cm:</i>	46
Seat depth in inches: <i>Sitztiefe in inches:</i>	18,11
WxDxH(SH) in inches:	20,87x18,11x29,13(18,50)

## Configurations

<b>Frame:</b>	Beech solid Black with felt glides
<b>Upholstery:</b>	Polyurethane foams
<b>Cover:</b>	Fixed cover

## Ausführungen

<b>Gestell:</b>	Buche massiv Schwarz mit Filzgleitern
<b>Polsterung:</b>	Polymousse
<b>Bezug:</b>	Fixbezug

# JOSEPH Design: Philippe Nigro

27812

27813

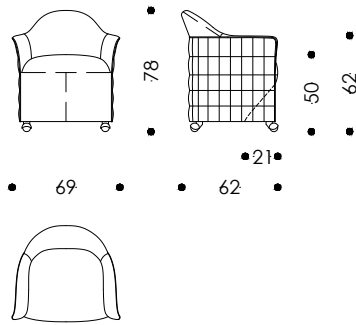
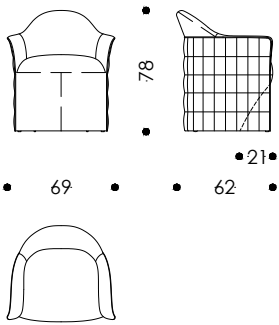

	27812	27813
Seat width in cm: <i>Sitzbreite in cm:</i>	48	48
Seat width in inches: <i>Sitzbreite in inches:</i>	18,90	18,90
Seat depth in cm: <i>Sitztiefe in cm:</i>	47	47
Seat depth in inches: <i>Sitztiefe in inches:</i>	18,50	18,50
<b>WxDxH(SH) in inches:</b>	27,17x24,41x30,17(19,69)	27,17x24,41x30,17(19,69)

## Configurations

<b>Frame:</b>	Metal- wooden construction
<b>Feet:</b>	
27812:	4x recessed castors (suitable for hard- and soft floors)
27813:	4x Castors in black- or chrome colour (suitable for hard floors)
<b>Upholstery:</b>	
Seat, Backrest:	Fixed webbing, pocket springs and polyurethane foams sandwich layered with dacron overlay
Shell:	polyurethane foams with dacron overlay
<b>Cover:</b>	Fixed cover with piping on the shell
unicolour:	Shell same as seat/ backrest
multicolour:	Shell in different colour
<b>Piping:</b>	Same as shell

## Ausführungen

<b>Gestell:</b>	Metall- Holzkonstruktion
<b>FüÙe:</b>	
27812:	4x versenkte Rollen (geeignet für harte- und weiche Böden)
27813:	4x Sichtrollen in Schwarz- oder Chromfarbe (geeignet für harte Böden)
<b>Polsterung:</b>	
Sitz, Rückenlehne:	Starre Begurtung, Taschenfederkern und Polymousse Sandwichaufbau mit Vliesabdeckung
Schale:	Polymousse mit Vliesabdeckung
<b>Bezug:</b>	Fixbezug mit Keder auf der Schale
einfärbig:	Schale wie Sitz/ Rückenlehne
mehrfärbig:	Schale andersfärbig
<b>Keder:</b>	Wie Schale

# LESLIE Design: Soda Designers

20863

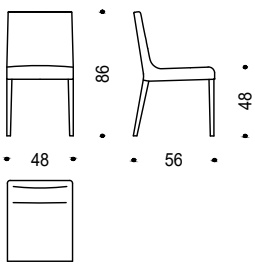

24363

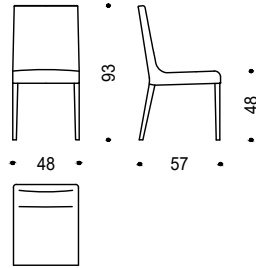

20864

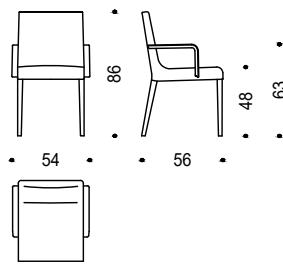

24364

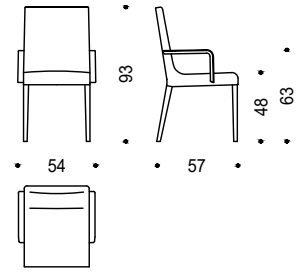

20883

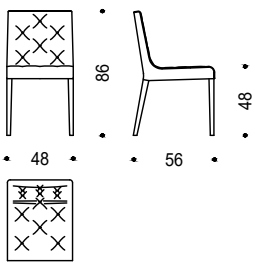

24383

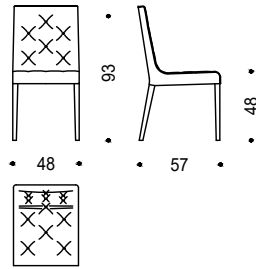

20884

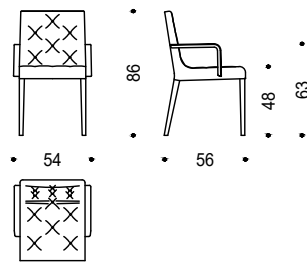

24384

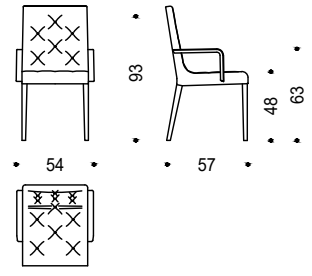

	20863/ 20883	24363/ 24383	20864/ 20884	24364/ 24384
<b>Seat width in cm:</b> <i>Sitzbreite in cm:</i>	48	48	48	48
<b>Seat width in inches:</b> <i>Sitzbreite in inches:</i>	18,90	18,90	18,90	18,90
<b>Seat depth in cm:</b> <i>Sitztiefe in cm:</i>	44	44	44	44
<b>Seat depth in inches:</b> <i>Sitztiefe in inches:</i>	17,42	17,42	17,42	17,42
<b>WxDxH(SH) in inches:</b>	18,90x25,59x33,86(18,90) 18,90x25,59x36,61(18,90) 21,26x35,59x33,86(18,90) 21,26x25,59x36,61(18,90)			

## Configurations

<b>Frame:</b>	Metal- wooden construction with steel spring
<b>Legs, Armrests:</b>	Beech solid Black with Teflon glides
<b>Surcharge:</b>	Oak solid or Walnut solid
<b>Upper armrests:</b>	Leather-covered (all colours)
<b>Upholstery:</b>	
<b>Seat:</b>	Fixed webbing with pocket springs and polyurethane foams with dacron overlay
<b>Arm-, Backrest:</b>	polyurethane foams with dacron overlay
<b>Cover:</b>	
<b>Plain:</b>	Fixed cover with flat piping
<b>Stitched:</b>	Fixed cover with tacked buttons and flat piping
<b>Flat piping:</b>	Same as cover

## Ausführungen

<b>Gestell:</b>	<i>Metall- Holzkonstruktion mit Stahlfeder</i>
<b>Beine, Armteile:</b>	<i>Buche massiv Schwarz mit Teflongleitern</i>
<b>Aufpreis:</b>	<i>Eiche massiv oder Nuss massiv</i>
<b>Armteile Oberteil:</b>	<i>Lederbezogen (alle Farben)</i>
<b>Polsterung:</b>	
<b>Sitz, Rückenlehne:</b>	<i>Starre Begurtung, Taschenfederkern und Polymousse mit Vliesabdeckung</i>
<b>Arm-, Rückenlehne:</b>	<i>Polymousse mit Vliesabdeckung</i>
<b>Bezug:</b>	
<b>Glatt:</b>	<i>Fixbezug mit Biese</i>
<b>Geheftet:</b>	<i>Fixbezug mit Knopfheftung und Biese</i>
<b>Biese:</b>	<i>Wie Bezug</i>

# LESLIE Design: Soda Designers

20865

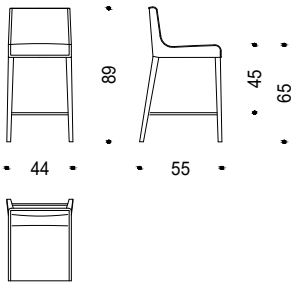

20866

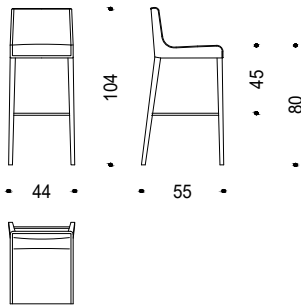

20885

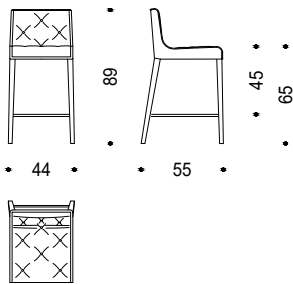

20886

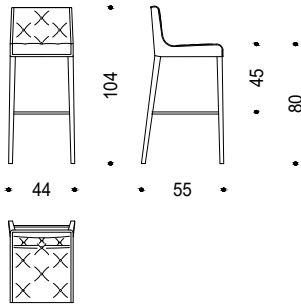

	20865/ 20885	20866/ 20886
<b>Seat width in cm:</b> <i>Sitzbreite in cm:</i>	42	42
<b>Seat width in inches:</b> <i>Sitzbreite in inches:</i>	16,54	16,54
<b>Seat depth in cm:</b> <i>Sitztiefe in cm:</i>	37	37
<b>Seat depth in inches:</b> <i>Sitztiefe in inches:</i>	14,57	14,57
<b>WxDxH(SH) in inches:</b>	17,32x21,65x35,04(25,59)	17,32x21,65x40,94(31,50)

## Configurations

<b>Frame:</b>	Metal- wooden construction
<b>Legs:</b>	Beech solid Black with Metal Black Grey foot ring and Teflon glides
<b>Surcharge:</b>	Oak solid or Walnut solid
<b>Upholstery:</b>	Fixed webbing with pocket springs and polyurethane foams sandwich layered with dacron overlay
<b>Cover:</b>	
Plain:	Fixed cover with flat piping
Stitched:	Fixed cover with tacked buttons and flat piping
<b>Flat piping:</b>	Same as cover

## Ausführungen

<b>Gestell:</b>	Metall- Holzkonstruktion
<b>Beine:</b>	Buche massiv Schwarz mit Metall Black Grey Fußring und Teflongleitern
<b>Aufpreis:</b>	Eiche massiv oder Nuss massiv
<b>Polsterung:</b>	Starre Begurtung, Taschenfederkern und Polymousse Sandwichaufbau mit Vliesabdeckung
<b>Bezug:</b>	
Glatt:	Fixbezug mit Biese
Geheftet:	Fixbezug mit Knopfheftung und Biese
<b>Biese:</b>	Wie Bezug

# MERWYN

Design: Sebastian Herkner

29363

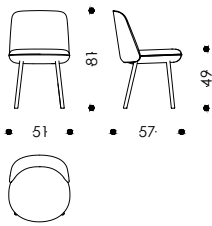

29364

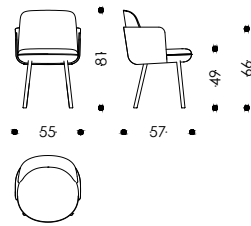

29365

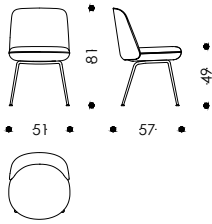

29366

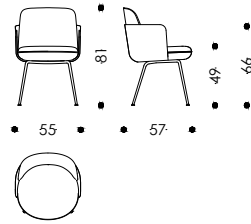

	29363	29364	29365	29366
<b>Seat width in cm:</b> <i>Sitzbreite in cm:</i>	51	51	51	51
<b>Seat width in inches:</b> <i>Sitzbreite in inches:</i>	20,08	20,08	20,08	20,08
<b>Seat depth in cm:</b> <i>Sitztiefe in cm:</i>	47	47	47	47
<b>Seat depth in inches:</b> <i>Sitztiefe in inches:</i>	18,50	18,50	18,50	18,50
<b>WxDxH(SH) in inches:</b>	20,08x21,65x31,89(19,29)	21,65x22,44x31,89(19,29)	20,08x21,65x31,89(19,29)	21,65x22,44x31,89(19,29)

## Configurations

<b>Frame:</b>	Metal- wooden construction
<b>Wooden legs:</b>	Beech solid Black with Teflon glides
<b>Surcharge:</b>	In Wittmann standard RAL colours or Oak solid
<b>Metal legs:</b>	Black Grey with Teflon glides
<b>Surcharge:</b>	Brass Satin Matt or Soft Copper
<b>Upholstery:</b>	
<b>Seat:</b>	High-resilient polyurethane foams foams with pocket springs and dacron overlay
<b>Backrest:</b>	High-resilient polyurethane foams with dacron overlay
<b>Armrest shell:</b> (29364, 29366)	Glass fiber reinforced nylon with dacron overlay
<b>Cover:</b>	
<b>Seat:</b>	Fixed cover with piping
<b>Backrest:</b>	Fixed cover
<b>Armrest shell:</b> (29364, 29366)	Fixed cover in leather
<b>Piping:</b>	Same as cover
<b>Without surcharge:</b>	Same as armrest shell or leather in standard colours Color Atlantic, Black, Cognac, Dark grey, Mocca, Sand, Siena and Taupe

## Ausführungen

<b>Gestell:</b>	<i>Metall- Holzkonstruktion</i>
<b>Holzbeine:</b>	<i>Buche massiv Schwarz mit Teflongleitern</i>
<b>Aufpreis:</b>	<i>In Wittmann Standard RAL Farben oder Eiche massiv</i>
<b>Metallbeine:</b>	<i>Black Grey mit Teflongleitern</i>
<b>Aufpreis:</b>	<i>Messing Satin Matt oder Soft Copper</i>
<b>Polsterung:</b>	
<b>Sitz:</b>	<i>Hoch belastbarer Polyurethan Schaumstoff mit Taschenfederkern und Vliesabdeckung</i>
<b>Rückenlehne:</b>	<i>Hoch belastbarer Polyurethan Schaumstoff mit Vliesabdeckung</i>
<b>Armteilschale:</b> (29364, 29366)	<i>Glasfaserverstärktes Polyamid mit Vliesabdeckung</i>
<b>Bezug:</b>	
<b>Sitz:</b>	<i>Fixbezug mit Keder</i>
<b>Lehne:</b>	<i>Fixbezug</i>
<b>Armteilschale:</b> (29364, 29366)	<i>Fixbezug in Leder</i>
<b>Keder:</b>	<i>Wie Bezug</i>
<b>Auf Wunsch:</b>	<i>Wie Armteilschale oder Leder in Standardfarben Color Atlantic, black, Cognac, Dark grey, Mocca, Sand, Siena und Taupe</i>

# MERWYN Design: Sebastian Herkner

29367

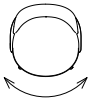
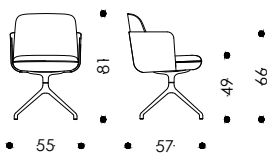

360° swivel  
360° drehbar

29368

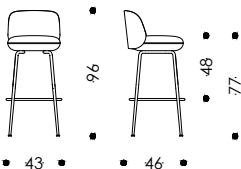

360° swivel  
360° drehbar

29369

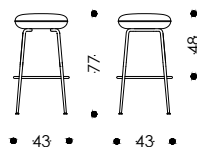

360° swivel  
360° drehbar

	29367	29368	29369
<b>Seat width in cm:</b> <b>Sitzbreite in cm:</b>	51	Ø43	Ø43
<b>Seat width in inches:</b> <b>Sitzbreite in inches:</b>	20,08	Ø16,93	Ø16,93
<b>Seat depth in cm:</b> <b>Sitztiefe in cm:</b>	47	Ø43	Ø43
<b>Seat depth in inches:</b> <b>Sitztiefe in inches:</b>	18,50	Ø16,93	Ø16,93
<b>WxDxH(SH) in inches:</b>	21,65x22,44x31,89(19,29)	16,93x18,11x37,80(30,32)	16,93x16,93x30,32

## Configurations

<b>Frame:</b>	Metal- wooden construction
<b>Legs (Chair):</b>	Metal Black Grey
<b>Surcharge:</b>	Aluminium polished
<b>Legs (Barstool):</b>	Metal Black Grey with Teflon glides
<b>Surcharge:</b>	Brass Satin Matt or Soft Copper
<b>Upholstery:</b>	
<b>Seat:</b>	High-resilient polyurethane foams with pocket springs and dacron overlay
<b>Backrest:</b>	High-resilient polyurethane foams with dacron overlay
<b>Armrest shell: (29367)</b>	Glass fiber reinforced nylon with dacron overlay
<b>Barstool:</b>	Polyurethane foams sandwich layered with dacron overlay Standard: British fire code
<b>Cover:</b>	
<b>Seat:</b>	Fixed cover with piping
<b>Backrest:</b>	Fixed cover
<b>Armrest shell: (29366)</b>	Fixed cover in leather
<b>Piping:</b>	Same as cover
<b>Without surcharge:</b>	Leather in standard colours Color Atlantic, Black, Cognac, Dark grey, Mocca, Sand, Siena and Taupe or same as armrest shell (29366)

## Ausführungen

<b>Gestell:</b>	Metall- Holzkonstruktion
<b>Beine (Stuhl):</b>	Metall Black Grey
<b>Aufpreis:</b>	Aluminium poliert
<b>Beine (Barstuhl):</b>	Metall Black Grey mit Teflongleitern
<b>Aufpreis:</b>	Messing Satin Matt oder Soft Copper
<b>Polsterung:</b>	
<b>Sitz:</b>	Hoch belastbarer Polyurethan Schaumstoff mit Taschenfederkern und Vliesabdeckung
<b>Rückenlehne:</b>	Hoch belastbarer Polyurethan Schaumstoff mit Vliesabdeckung
<b>Armteilschale: (29367)</b>	Glasfaserverstärktes Polyamid mit Vliesabdeckung
<b>Barstuhl:</b>	Polymousse Sandwichaufbau mit Vliesabdeckung Standard: British Feuercode
<b>Bezug:</b>	
<b>Sitz:</b>	Fixbezug mit Keder
<b>Lehne:</b>	Fixbezug
<b>Armteilschale: (29366)</b>	Fixbezug in Leder
<b>Keder:</b>	Wie Bezug
<b>Auf Wunsch:</b>	Leder in Standardfarben Color Atlantic, black, Cognac, Dark grey, Mocca, Sand, Siena und Taupe oder wie Armteilschale (29366)

# MERWYN DINING

Design: Sebastian Herkner

29712

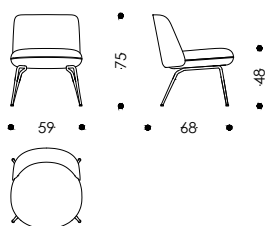

29713

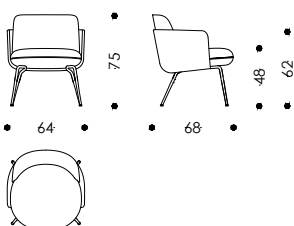

29720

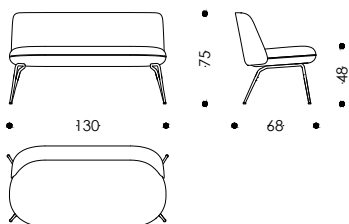

29725

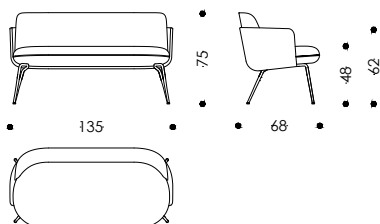

	29712	29713	29720	29725
<b>Seat width in cm:</b> <b>Sitzbreite in cm:</b>	59	59	130	130
<b>Seat width in inches:</b> <b>Sitzbreite in inches:</b>	23,23	23,23	51,18	51,18
<b>Seat depth in cm:</b> <b>Sitztiefe in cm:</b>	53	53	53	53
<b>Seat depth in inches:</b> <b>Sitztiefe in inches:</b>	20,87	20,87	20,87	20,87
<b>WxDxH(SH) in inches:</b>	23,23x26,77x29,53(18,90)	25,20x26,77x29,53(18,90)	51,18x26,77x29,53(18,90)	53,15x29,53x26,77(18,90)

## Configurations

<b>Frame:</b>	Metal- wooden construction
<b>Legs:</b>	Metal Black Grey with Teflon glides
<b>Surcharge:</b>	Brass Satin Matt or Soft Copper
<b>Upholstery:</b>	
<b>Seat:</b>	High-resilient polyurethane foams with pocket springs and dacron overlay
<b>Backrest:</b>	High-resilient polyurethane foams with dacron overlay
<b>Armrest shell:</b> (Neue Nr., 29725)	Glass fiber reinforced nylon with dacron overlay
<b>Cover:</b>	
<b>Seat:</b>	Fixed cover with piping
<b>Backrest:</b>	Fixed cover
<b>Armrest shell:</b> (Neue Nr., 29725)	Fixed cover in leather
<b>Piping:</b>	Same as cover
<b>Without surcharge:</b>	Leather in standard colours Color Atlantic, Black, Cognac, Dark grey, Mocca, Sand, Siena and Taupe or same as armrest shell (Neue Nr., 29725)

## Ausführungen

<b>Gestell:</b>	<i>Metall- Holzkonstruktion</i>
<b>Beine:</b>	<i>Metall Black Grey mit Teflongleitern</i>
<b>Aufpreis:</b>	<i>Messing Satin Matt oder Soft Copper</i>
<b>Polsterung:</b>	
<b>Sitz:</b>	<i>Hoch belastbarer Polyurethan Schaumstoff mit Taschenfederkern und Vliesabdeckung</i>
<b>Rückenlehne:</b>	<i>Hoch belastbarer Polyurethan Schaumstoff mit Vliesabdeckung</i>
<b>Armteilschale:</b> (Neue Nr., 29725)	<i>Glasfaserverstärktes Polyamid mit Vliesabdeckung</i>
<b>Bezug:</b>	
<b>Sitz:</b>	<i>Fixbezug mit Keder</i>
<b>Lehne:</b>	<i>Fixbezug</i>
<b>Armteilschale:</b> (Neue Nr., 29725)	<i>Fixbezug in Leder</i>
<b>Keder:</b>	<i>Wie Bezug</i>
<b>Auf Wunsch:</b>	<i>Leder in Standardfarben Color Atlantic, Black, Cognac, Dark grey, Mocca, Sand, Siena und Taupe oder wie Armteilschale (Neue Nr., 29725)</i>

# MILES DINING Design: Sebastian Herkner

27112

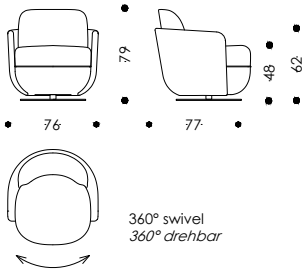

27120

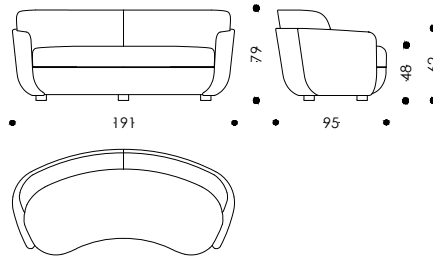

27125

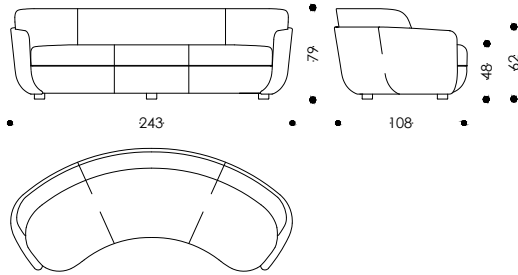

27130

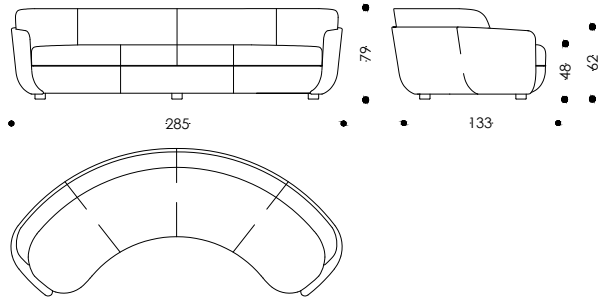

	27112	27120	27125	27130
<b>Seat width in cm:</b> <b>Sitzbreite in cm:</b>	65	172	218	257
<b>Seat width in inches:</b> <b>Sitzbreite in inches:</b>	25,59	67,72	85,83	101,18
<b>Seat depth in cm:</b> <b>Sitztiefe in cm:</b>	57	57	57	57
<b>Seat depth in inches:</b> <b>Sitztiefe in inches:</b>	22,44	22,44	22,44	22,44
<b>WxDxH(SH) in inches:</b>	29,92x30,32x29,53(18,90)	75,20x37,00x29,13(18,90)	95,66x42,52x29,13(18,90)	95,66x42,52x29,13(18,90)

## Configurations

### Frame:

Armchair, Sofa: Metal- wooden construction  
Stool: Wooden construction

### Feet:

Armchair: Black metal swivel base with felt glides  
Sofa: Black plastic feet with felt glides

### Upholstery:

Seat: Coil springs with polyurethane foams sandwich layered and dacron overlay  
Backrest: Polyurethane foams sandwich layered with dacron overlay  
Armrest shell: High resilience polyurethane foams with dacron overlay  
Stool: Polyurethane foams sandwich layered with dacron overlay  
Cover: Fixed cover with piping  
Piping: Same as cover  
Without surcharge: Leather in standard colours Color Atlantic, Black, Cognac, Dark grey, Mocca, Sand, Siena and Taupe

## Ausführungen

### Gestell:

Fauteuil, Sofa: Metall- Holzkonstruktion  
Hocker: Holzkonstruktion

### FüÙe:

Fauteuil: Metall Drehteller Schwarz mit Filzgleitern  
Sofa: Schwarze KunststofffüÙe mit Filzgleitern

### Polsterung:

Sitz: Federkern mit Polymousse Sandwichaufbau und Vliesabdeckung  
Rückenlehne: Polymousse Sandwichaufbau mit Vliesabdeckung  
Armteilschale: Hoch belastbarer Polyurethan Schaumstoff mit Vliesabdeckung  
Hocker: Polymousse Sandwichaufbau mit Vliesabdeckung  
Bezug: Fixbezug mit Keder  
Keder: Wie Bezug  
Auf Wunsch: Leder in Standardfarben Color Atlantic, Black, Cognac, Dark grey, Mocca, Sand, Siena und Taupe



# MONO

Design: Marco Dessi

26112

26142

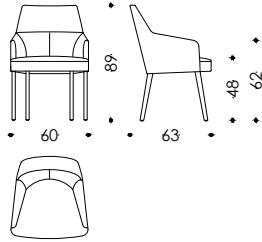
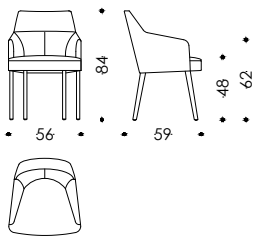

	26112	26142
Seat width in cm: <i>Sitzbreite in cm:</i>	49	53
Seat width in inches: <i>Sitzbreite in inches:</i>	19,29	20,87
Seat depth in cm: <i>Sitztiefe in cm:</i>	43	47
Seat depth in inches: <i>Sitztiefe in inches:</i>	16,93	18,50
<b>WxDxH(SH) in inches:</b>	22,05x23,23x33,07(18,90)	23,62x24,80x35,04(18,90)

## Configurations

<b>Frame:</b>	Metal construction
<b>Legs:</b>	Beech solid Black with Teflon glides
<b>Surcharge:</b>	In Wittmann standard RAL colours, Oak solid or Walnut solid
<b>Upholstery:</b>	
<b>Seat:</b>	Elastic webbing, polyurethane foams sandwich layered with dacron overlay
<b>Shell:</b>	High-resilience polyurethane foams with dacron overlay
<b>Cover:</b>	Fixed cover

## Ausführungen

<b>Gestell:</b>	Metallkonstruktion
<b>Beine:</b>	Buche massiv Schwarz mit Teflingleitern
<b>Aufpreis:</b>	In Wittmann Standard RAL Farben, Eiche massiv oder Nuss massiv
<b>Polsterung:</b>	
<b>Sitz:</b>	Elastische Begurtung, Polymousse Sandwichaufbau mit Vliesabdeckung
<b>Schale:</b>	Hoch belastbarer Polyurethan Schaumstoff mit Vliesabdeckung
<b>Bezug:</b>	Fixbezug

# MORTON Design: Sebastian Herkner

22195

22196

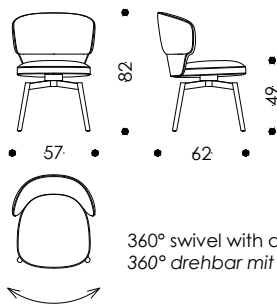
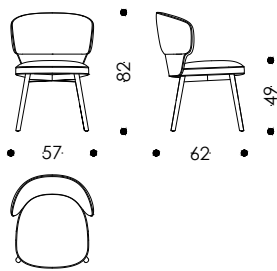

360° swivel with automatic return  
360° drehbar mit Rückholautomatik

22194

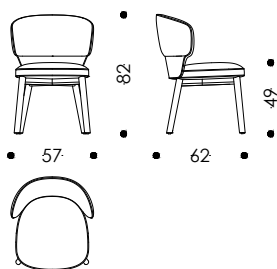

	22195	22196	22194
Seat width in cm: <i>Sitzbreite in cm:</i>	48	48	48
Seat width in inches: <i>Sitzbreite in inches:</i>	18,90	18,90	18,90
Seat depth in cm: <i>Sitztiefe in cm:</i>	50	50	50
Seat depth in inches: <i>Sitztiefe in inches:</i>	19,69	19,69	19,69
<b>WxDxH(SH) in inches:</b>	22,44x24,41x32,28(19,29)	22,44x24,41x32,28(19,29)	22,44x24,41x32,28(19,29)

## Configurations

<b>Frame:</b>	Wooden construction with slightly flexible shell
<b>Legs (22195):</b>	Metal Black Grey with Teflon glides
<b>Legs (22196):</b>	Metal Black Grey with Teflon glides, swivel mechanism with automatic return
<b>Legs (22194):</b>	Ash solid Black with Teflon glides
<b>Surcharge:</b>	Walnut solid
<b>Upholstery:</b>	
<b>Seat:</b>	Pocket springs and polyurethane foams sandwich layered with dacron overlay
<b>Shell:</b>	Polyurethane foams sandwich layered with dacron overlay
<b>Cover:</b>	Fixed cover with piping
<b>Piping:</b>	Same as cover (unicolour), same as seat (multicolour)
<b>Without surcharge:</b>	Leather in standard colours Color Atlantic, Black, Cognac, Dark grey, Mocca, Sand, Siena and Taupe

## Ausführungen

<b>Gestell:</b>	Holzkonstruktion mit leicht flexibler Schale
<b>Beine (22195):</b>	Metall Black Grey mit Teflingleitern
<b>Beine (22196):</b>	Metall Black Grey mit Teflingleitern, Drehmechanismus mit Rückholautomatik
<b>Beine (22194):</b>	Esche massiv Schwarz mit Teflingleitern
<b>Aufpreis:</b>	Nuss massiv
<b>Polsterung:</b>	
<b>Sitz:</b>	Taschenfederkern und Polymousse Sandwichaufbau mit Vliesabdeckung
<b>Schale:</b>	Polymousse Sandwichaufbau mit Vliesabdeckung
<b>Bezug:</b>	Fixbezug mit Keder
<b>Keder:</b>	Wie Bezug (einfärbig), Wie Sitz (mehrfärbig)
<b>Auf Wunsch:</b>	Leder in Standardfarben Color Atlantic, Black, Cognac, Dark grey, Mocca, Sand, Siena und Taupe

# MORTON FD

Design: Sebastian Herkner

22165

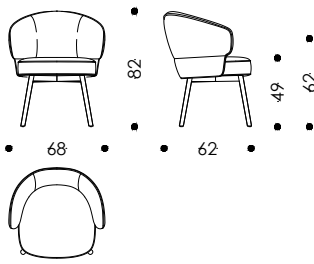

22166

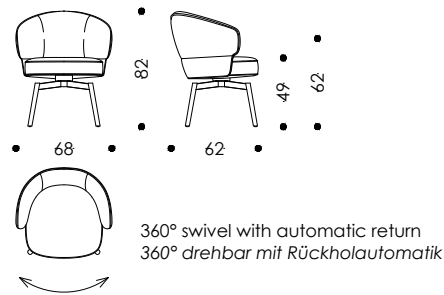

22164

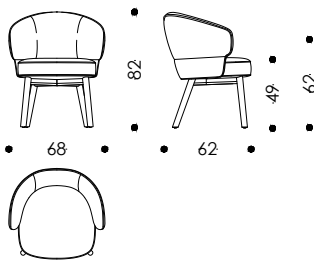

	22165	22166	22164
<b>Seat width in cm:</b> <b>Sitzbreite in cm:</b>	56	56	56
<b>Seat width in inches:</b> <b>Sitzbreite in inches:</b>	22,05	22,05	22,05
<b>Seat depth in cm:</b> <b>Sitztiefe in cm:</b>	52	52	52
<b>Seat depth in inches:</b> <b>Sitztiefe in inches:</b>	20,48	20,48	20,48
<b>WxDxH(SH) in inches:</b>	26,78x24,41x32,28(19,29)	26,78x24,41x32,28(19,29)	26,78x24,41x32,28(19,29)

## Configurations

<b>Frame:</b>	Wooden construction with slightly flexible shell
<b>Legs (22165):</b>	Metal Black Grey with Teflon glides
<b>Legs (22166):</b>	Metal Black Grey with Teflon glides, swivel mechanism with automatic return
<b>Legs (22164):</b>	Ash solid Black with Teflon glides
<b>Surcharge:</b>	Walnut solid
<b>Upholstery:</b>	
<b>Seat:</b>	Pocket springs and polyurethane foams sandwich layered with dacron overlay
<b>Shell:</b>	Polyurethane foams sandwich layered with dacron overlay
<b>Cover:</b>	Fixed cover with piping
<b>Piping:</b>	Same as cover (unicolour), same as seat (multicolour)
<b>Without surcharge:</b>	Leather in standard colours Color Atlantic, Black, Cognac, Dark grey, Mocca, Sand, Siena and Taupe

## Ausführungen

<b>Gestell:</b>	Holzkonstruktion mit leicht flexibler Schale
<b>Beine (22165):</b>	Metall Black Grey mit Teflingleitern
<b>Beine (22166):</b>	Metall Black Grey mit Teflingleitern, Drehmechanismus mit Rückholautomatik
<b>Beine (22164):</b>	Esche massiv Schwarz mit Teflingleitern
<b>Aufpreis:</b>	Nuss massiv
<b>Polsterung:</b>	
<b>Sitz:</b>	Taschenfederkern und Polymousse Sandwichaufbau mit Vliesabdeckung
<b>Schale:</b>	Polymousse Sandwichaufbau mit Vliesabdeckung
<b>Bezug:</b>	Fixbezug mit Keder
<b>Keder:</b>	Wie Bezug (einfärbig), Wie Sitz (mehrfärbig)
<b>Auf Wunsch:</b>	Leder in Standardfarben Color Atlantic, Black, Cognac, Dark grey, Mocca, Sand, Siena und Taupe

# NILS Design: Soda Designers

23563

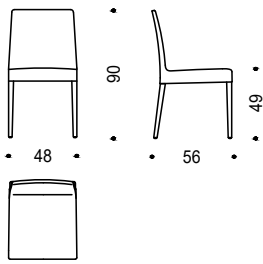

23566

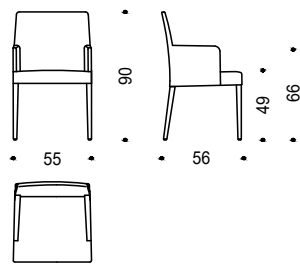

23564

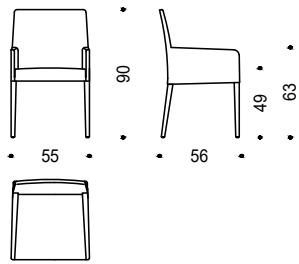

23565

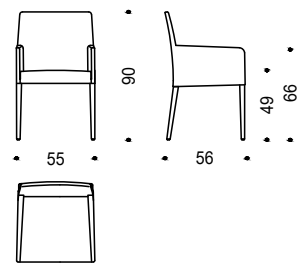

	23563	23566	23564	23565
<b>Seat width in cm:</b> <i>Sitzbreite in cm:</i>	47	48	48	48
<b>Seat width in inches:</b> <i>Sitzbreite in inches:</i>	18,50	18,90	18,90	18,90
<b>Seat depth in cm:</b> <i>Sitztiefe in cm:</i>	45	45	45	45
<b>Seat depth in inches:</b> <i>Sitztiefe in inches:</i>	17,72	17,72	17,72	17,72
<b>WxDxH(SH) in inches:</b>	18,90x22,05x35,43(19,29)	21,65x22,05x35,43(19,29)	21,65x22,05x35,43(19,29)	21,65x22,05x35,43(19,29)

## Configurations

<b>Frame:</b>	Metal- wooden construction
<b>Legs:</b>	Beech solid Black with Teflon glides
<b>Surcharge:</b>	in Wittmann standard RAL colours, Oak solid or Walnut solid
<b>Upholstery:</b>	
<b>Seat:</b>	Elastic webbing, pocket springs and polyurethane foams sandwich layered with dacron overlay
<b>Arm-, Backrest:</b>	Polyurethane foams with dacron overlay
<b>Cover:</b>	Fixed cover
<b>Surcharge:</b>	Removable cover (fabric only)

## Ausführungen

<b>Gestell:</b>	Metall- Holzkonstruktion
<b>Beine:</b>	Buche massiv Schwarz mit Teflingleitern
<b>Aufpreis:</b>	In Wittmann Standard RAL Farben, Eiche massiv oder Nuss massiv
<b>Polsterung:</b>	
<b>Sitz:</b>	Elastische Begurtung, Taschenfederkern und Polymousse Sandwichaufbau mit Vliesabdeckung
<b>Arm-, Rückenlehne:</b>	Polymousse mit Vliesabdeckung
<b>Bezug:</b>	Fixbezug
<b>Aufpreis:</b>	Bezug abnehmbar (nur Stoff)

# ODEON Design: Marco Dessi

25325

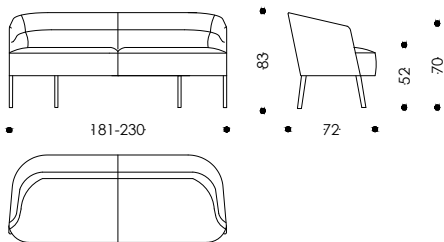

25330

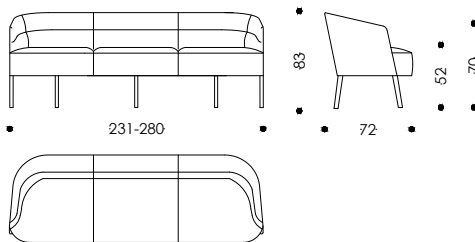

25335

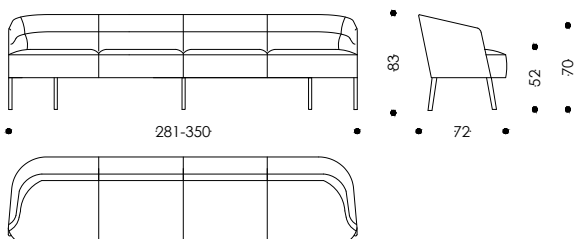

Measurement is freely selectable in indicated ranges. Please specify desired width to the order.  
Das Maß ist frei wählbar in den angegebenen Bereichen. Bitte bei der Bestellung die gewünschte Breite angeben.

	25325	25330	25335
<b>Seat width in cm:</b> <i>Sitzbreite in cm:</i>	161 - 210	211 - 260	261 - 330
<b>Seat width in inches:</b> <i>Sitzbreite in inches:</i>	63,39 - 82,68	83,07 - 102,36	102,76 - 129,92
<b>Seat depth in cm:</b> <i>Sitztiefe in cm:</i>	45	45	45
<b>Seat depth in inches:</b> <i>Sitztiefe in inches:</i>	17,72	17,72	17,72
<b>WxDxH(SH) in inches:</b>	71,26-90,55x28,35x 32,68(20,47)	90,94-110,24x28,35x 32,68(20,47)	110,63-130,80x28,35x 32,68(20,47)

## Configurations

<b>Frame:</b>	Metal- wooden construction
<b>Legs:</b>	Beech solid Black with Teflon glides
<b>Surcharge:</b>	In Wittmann standard RAL colours or Walnut solid
<b>Upholstery:</b>	
<b>Seat:</b>	Coil springs with jute overlay and polyurethane foams sandwich layered
<b>Arm-, Backrest:</b>	Polyurethane foams sandwich layered
<b>Cover:</b>	Fixed cover with piping

## Ausführungen

<b>Gestell:</b>	Metal- Holzkonstruktion
<b>Beine:</b>	Buche massiv Schwarz mit Teflongleitern
<b>Aufpreis:</b>	In Wittmann Standard RAL Farben oder Nuss massiv
<b>Polsterung:</b>	
<b>Sitz:</b>	Federkern mit Juteabdeckung und Polymousse Sandwichaufbau
<b>Arm-, Rückenlehne:</b>	Polymousse Sandwichaufbau
<b>Bezug:</b>	Fixbezug mit Keder

# PARADISE BIRD

Design: Luca Nichetto

26464

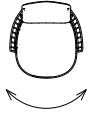
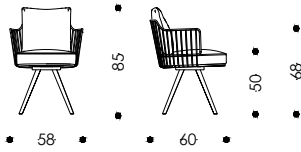

360° swivel with automatic return  
360° drehbar mit Rückholautomatik

26464	
Seat width in cm: <i>Sitzbreite in cm:</i>	48
Seat width in inches: <i>Sitzbreite in inches:</i>	18,90
Seat depth in cm: <i>Sitztiefe in cm:</i>	42
Seat depth in inches: <i>Sitztiefe in inches:</i>	16,54
WxDxH(SH) in inches:	22,83x23,62x33,46(19,69)

## Configurations

<b>Corpus:</b>	Metal- wooden construction
<b>Frame, Legs:</b>	Metal Black Grey with Teflon glides
<b>Surcharge:</b>	Brass Satin Matt or Soft Copper
<b>Upholstery:</b>	
<b>Seat:</b>	Pocket springs and polyurethane foams sandwich layered with dacron overlay
<b>Back Cushion:</b>	100% feather filling with polyurethane core
<b>Cover:</b>	
<b>Seat:</b>	Fixed cover with piping
<b>Cushion:</b>	Removable cover with piping, same as seat
<b>Piping:</b>	Same as cover
<b>Without surcharge:</b>	Leather in standard colours Color Atlantic, Black, Cognac, Dark grey, Mocca, Sand, Siena and Taupe

## Ausführungen

<b>Korpus:</b>	Metal- Holzkonstruktion
<b>Gestell, Beine:</b>	Metal Black Grey mit Teflingleitern
<b>Aufpreis:</b>	Messing Satin Matt oder Soft Copper
<b>Polsterung:</b>	
<b>Sitz:</b>	Taschenfederkern und Polymousse Sandwichaufbau mit Vliesabdeckung
<b>Lehnkissen:</b>	100% Federnfüllung mit Polymousse Kern
<b>Bezug:</b>	
<b>Sitz:</b>	Fixbezug mit Keder
<b>Kissen:</b>	Bezug abnehmbar mit Keder, wie Sitz
<b>Keder:</b>	Wie Bezug
<b>Auf Wunsch:</b>	Leder in Standardfarben Color Atlantic, Black, Cognac, Dark grey, Mocca, Sand, Siena und Taupe

# SEDAN

Design: Jan Armgardt

11063

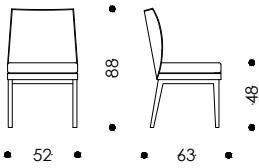

11064

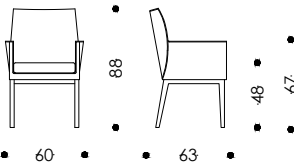

	11063	11064
Seat width in cm: <i>Sitzbreite in cm:</i>	52	44
Seat width in inches: <i>Sitzbreite in inches:</i>	20,47	17,32
Seat depth in cm: <i>Sitztiefe in cm:</i>	44	44
Seat depth in inches: <i>Sitztiefe in inches:</i>	17,32	17,32
WxDxH(SH) in inches:	20,47x24,80x34,65(18,90)	23,62x24,80x34,65(18,90)

## Configurations

<b>Frame:</b>	Metal- wooden construction
<b>Legs:</b>	Beech solid Black with Teflon glides
<b>Surcharge:</b>	In Wittmann standard RAL colours, Oak solid or Walnut solid
<b>Upholstery:</b>	
<b>Seat cushion:</b>	Loose cushion attachable with velcro, elastic webbing, Polyurethane foams with dacron overlay
<b>Arm-, Backrest:</b>	Polyurethane foams with dacron overlay
<b>Cover:</b>	Fixed cover with flat piping
<b>Flat piping:</b>	Same as cover (Cover in leather or unicoloured fabric)  In unicoloured fabric (Cover in patterned fabric)
<b>Without surcharge:</b>	Leather in standard colours Color Atlantic, Black, Cognac, Dark grey, Mocca, Sand, Siena and Taupe

## Ausführungen

<b>Gestell:</b>	<i>Metall- Holzkonstruktion</i>
<b>Beine:</b>	<i>Buche massiv Schwarz mit Teflungleitern</i>
<b>Aufpreis:</b>	<i>In Wittmann Standard RAL Farben, Eiche massiv oder Nuss massiv</i>
<b>Polsterung:</b>	
<b>Sitzkissen:</b>	<i>Lose Kissen mit Klettband fixierbar, elastische Begurtung, Polymousse mit Vliesabdeckung</i>
<b>Arm-, Rückenlehne:</b>	<i>Polymousse mit Vliesabdeckung</i>
<b>Bezug:</b>	<i>Fixbezug mit Biese</i>
<b>Biese:</b>	<i>Wie Bezug (Bezug in Leder oder einfarbigem Stoff)  In einfarbigem Stoff (Bezug in gemustertem Stoff)</i>
<b>Auf Wunsch:</b>	<i>Leder in Standardfarben Color Atlantic, Black, Cognac, Dark grey, Mocca, Sand, Siena und Taupe</i>

# TOGA Design: Jan Armgardt

22663

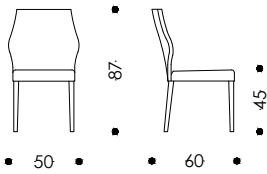

22664

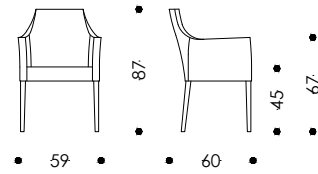

	22663	22664
<b>Seat width in cm:</b> <i>Sitzbreite in cm:</i>	47	45
<b>Seat width in inches:</b> <i>Sitzbreite in inches:</i>	18,50	17,72
<b>Seat depth in cm:</b> <i>Sitztiefe in cm:</i>	44	44
<b>Seat depth in inches:</b> <i>Sitztiefe in inches:</i>	17,32	17,32
<b>WxDxH(SH) in inches:</b>	19,69x23,62x34,25(17,72)	23,23x23,62x34,25(17,72)

## Configurations

<b>Frame:</b>	Metal- wooden construction
<b>Legs:</b>	Beech solid Black with Teflon glides
<b>Surcharge:</b>	In Wittmann standard RAL colours
<b>Upholstery:</b>	
<b>Seat:</b>	Elastic webbing, Polyurethane foams with dacron overlay
<b>Arm-, Backrest:</b>	Elastic covering, polyurethane foams with dacron overlay
<b>Cover:</b>	Fixed cover with zip on rear side (22664)

## Ausführungen

<b>Gestell:</b>	Metal- Holzkonstruktion
<b>Beine:</b>	Buche massiv Schwarz mit Teflungleitern
<b>Aufpreis:</b>	In Wittmann Standard RAL Farben
<b>Polsterung:</b>	
<b>Sitz:</b>	Elastische Begurtung, Polymousse mit Vliesabdeckung
<b>Arm-, Rückenlehne:</b>	Elastische Bespannung, Polymousse mit Vliesabdeckung
<b>Bezug:</b>	Fixbezug mit Zipp auf der Hinterseite (22664)



# VUELTA FD Design: Jaime Hayon

25663

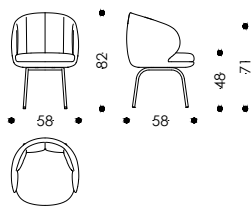

25665

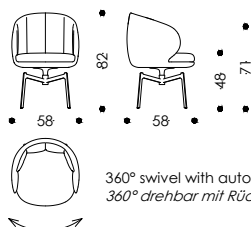

360° swivel with automatic return  
360° drehbar mit Rückholautomatik

25664

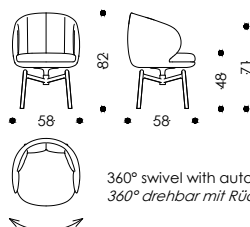

360° swivel with automatic return  
360° drehbar mit Rückholautomatik

	25663	25665/ 25664
<b>Seat width in cm:</b> <i>Sitzbreite in cm:</i>	46	46
<b>Seat width in inches:</b> <i>Sitzbreite in inches:</i>	18,11	18,11
<b>Seat depth in cm:</b> <i>Sitztiefe in cm:</i>	47	47
<b>Seat depth in inches:</b> <i>Sitztiefe in inches:</i>	18,50	18,50
<b>WxDxH(SH) in inches:</b>	22,83x22,83x32,28(18,90)	22,83x22,83x32,28(18,90)

## Configurations

<b>Frame:</b>	Metal- wooden construction
<b>Legs (25663):</b>	Metal Black Grey with Teflon glides
Surcharge:	Brass Satin Matt
<b>Legs: (25665, 25664)</b>	Metal Black Grey with swivel mechanism and Teflon glides
Surcharge:	Swivel mechanism with automatic return
<b>Foot sleeves: (25664)</b>	Beech solid Black with magnets
Surcharge:	In Wittmann standard RAL colours, Oak solid or Walnut solid
<b>Upholstery:</b>	High resilience polyurethane foams with polyurethane pads and dacron overlay
<b>Cover:</b>	Stitched fixed cover with seams

## Ausführungen

<b>Gestell:</b>	Metall- Holzkonstruktion
<b>Beine (25663):</b>	Metall Black Grey mit Teflongleitern
Aufpreis:	Messing Satin Matt
<b>Beine: (25665, 25664)</b>	Metall Black Grey mit Drehmechanismus und Teflongleitern
Aufpreis:	Drehmechanismus mit Rückholautomatik
<b>Fußhülsen: (25664)</b>	Buche massiv Schwarz mit Magneten
Aufpreis:	In Wittmann Standard RAL Farben, Eiche massiv oder Nuss massiv
<b>Polsterung:</b>	Hoch belastbarer Polyurethan Schaumstoff mit Polyurethan-Pads und Vliesabdeckung
<b>Bezug:</b>	Gesteppter Fixbezug mit Steppnaht

# ACACIA

Design: Luca Nichetto

26490

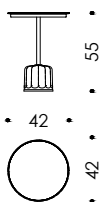

26490

**WxDxH (leg room) in cm:**

Ø42x55

**BxTxH (Beinfreiheit) in cm:**

**WxDxH (leg room) in inches:**

Ø16,54x21,65

## Configurations

**Frame:** Metal Black Chrome, tray liner covered in black felt

**Tabletop:** Leather tray in Color or Nappa

**Base:** Murano Glass Clear

Without surcharge: Murano Glass Verde

## Ausführungen

**Gestell:** Metall Schwarzchrom, Tabletteinlage in schwarzen Filzstoff bezogen

**Tischplatte:** Ledertablett in Color oder Nappa

**Sockel:** Murano Glas Clear

Auf Wunsch: Murano Glas Verde

# ADÈLE Design: Philippe Nigro

28490

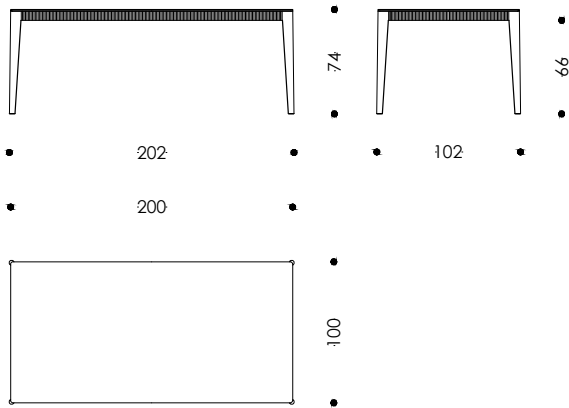

28493

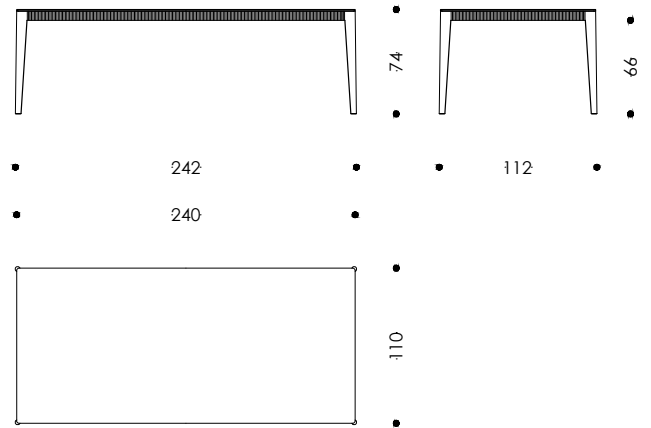

Detailed view/ *Detailansicht*

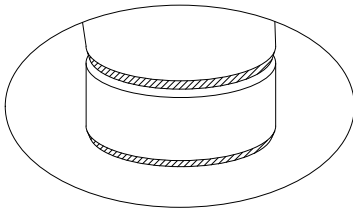

Riser for table height 75cm/  
*Fußaufsatz für Tischhöhe 75cm*

	28490	28493
<b>WxDxH (leg room) in cm:</b>		
<b>BxTxH (Beinfreiheit) in cm:</b>	202x102x74(66)	242x112x74(66)
<b>WxDxH (leg room) in inches:</b>	79,53x40,16x29,13(25,98)	95,28x44,09x29,13(25,98)

## Configurations

**Frame:** Ash solid Black with felt glides  
**Tabletop:** Covered in leather Nappa Schwarz or Basalt  
**Table height:** 74cm  
**Surcharge:** 75cm with 4x risers, Metal Black Grey

## Ausführungen

**Gestell:** Esche massiv Schwarz mit Filzgleitern  
**Tischplatte:** Lederbezogen in Nappa Schwarz oder Basalt  
**Tischhöhe:** 74cm  
**Aufpreis:** 75cm mit 4x Fußaufsätzen, Metall Black Grey

# ANDES Design: Luca Nichetto

26912

26913

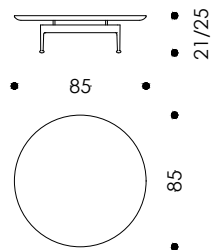
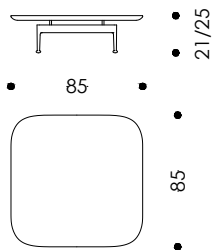

	29612	29613
<b>WxDxH (leg room) in cm:</b>	85x85x21/25	Ø85x21/25
<b>BxTxH (Beinfreiheit) in cm:</b>	85x85x21/25	Ø85x21/25
<b>WxDxH (leg room) in inches:</b>	33,46x33,46x8,27/9,84	Ø33,46x8,27/9,84

## Configurations

**Legs:** Metal Black Grey with leather fiber glides  
 Surcharge: Brass Satin Matt  
**Tabletop:** Walnut veneer  
 Surcharge: Marble Frappuccino  
**Table height:** 21cm  
 Without surcharge: 25cm

## Ausführungen

**Beine:** Metall Black Grey mit Lederfasergleitern  
 Aufpreis: Messing Satin Matt  
**Tischplatte:** Nuss furniert  
 Aufpreis: Marmor Frappuccino  
**Tischhöhe:** 21cm  
 Auf Wunsch: 25cm

# ANTILLES

Design: Luca Nichetto

26990 (BLU)

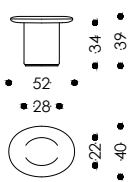

26991 (GIALLO)

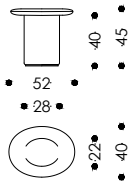

26992 (ROSSO)

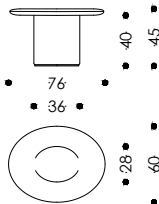

26993 (VERDE)

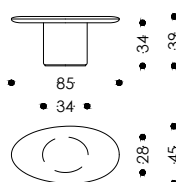

	26990	26991	26992	26993
<b>WxDxH (leg room) in cm:</b>				
<b>BxTxH (Beinfreiheit) in cm:</b>	52x40x39(34)	52x40x45(40)	76x60x45(40)	85x45x39(34)
<b>WxDxH (leg room) in inches:</b>	20,47x15,75x15,35(13,39)	20,47x15,75x17,72(15,75)	29,92x23,62x17,72(15,75)	33,46x17,72x15,35(13,39)

## Configurations

**Base:** Leather covered in Color Black with felt glides

### Tabletop:

BLU (26990): Granite Labrador Blue Pearl

GIALLO (26991): Marble Giallo Reale

ROSSO (26992): Marble Rosso Asiago

VERDE (26993): Marble Verde Guatemala

## Ausführungen

**Socket:** Lederbezogen in Color Black mit Filzgleitern

### Tischplatte:

BLU (26990): Granit Labrador Blue Pearl

GIALLO (26991): Marmor Giallo Reale

ROSSO (26992): Marmor Rosso Asiago

VERDE (26993): Marmor Verde Guatemala

# ANTILLES DINING

Design: Luca Nichetto

26980

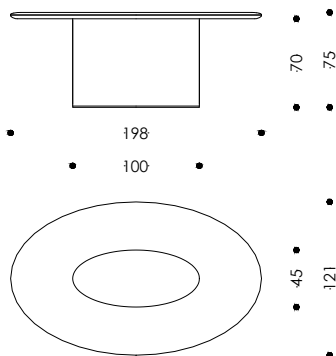

26981

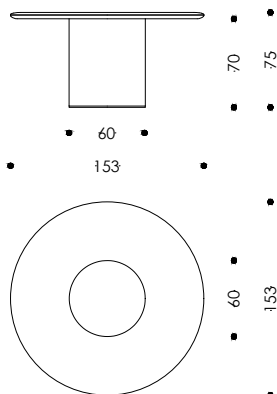

	26980	26981
<b>WxDxH (leg room) in cm:</b>	198x121x75(70)	Ø153x75(70)
<b>BxTxH (Beinfreiheit) in cm:</b>	198x121x75(70)	Ø153x75(70)
<b>WxDxH (leg room) in inches:</b>	77,95x47,64x 29,53(27,56)	Ø60,24x29,53(27,56)

## Configurations

**Base:** Leather covered in Color Black with felt glides  
**Tabletop:** Marble Emperador Silver  
 Without surcharge: Marble Carrara White

## Ausführungen

**Socket:** Lederbezogen in Color Black mit Filzgleitern  
**Tischplatte:** Marmor Emperador Silver  
 Auf Wunsch: Marmor Carrara White

# BATON Design: Neri&Hu

24990

24991

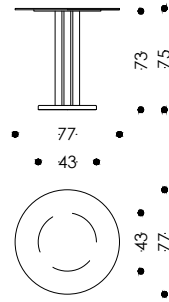
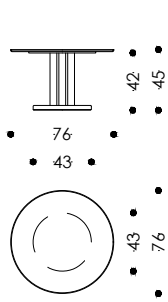

Perspective View / Perspektivansicht

24990

24991

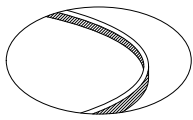

Bowl-shaped tabletop/  
Tischplatte schalenförmig

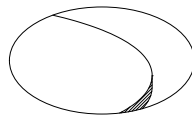

Plain tabletop/  
Tischplatte glatt

	24990	24991
<b>WxDxH (leg room) in cm:</b>		
<b>BxTxH (Beinfreiheit) in cm:</b>	Ø76x45(42)	Ø77x75(73)
<b>WxDxH (leg room) in inches:</b>	Ø29,92x17,72(16,54)	Ø30,32x29,53(28,74)

## Configurations

<b>Frame:</b>	Metal Black Grey
<b>Tabletop:</b>	Metal Black Grey
<b>Columns:</b>	Metal construction, leather-covered
<b>Base:</b>	Marble on black metal plate with felt glides
<b>Variants:</b>	Base: Marble Nero Marquina Columns: Nappa Schwarz  Base: Marble Nero Marquina Columns: Nappa Siena  Base: Marble Verde Guatemala Columns: Nappa Verde

## Ausführungen

<b>Gestell:</b>	Metall Black Grey
<b>Tischplatte:</b>	Metall Black Grey
<b>Säule:</b>	Metallkonstruktion lederbezogen
<b>Socket:</b>	Marmor auf schwarzer Metallplatte mit Filzgleitern
<b>Variante:</b>	Socket: Marmor Nero Marquina Säule: Nappa Schwarz  Socket: Marmor Nero Marquina Säule: Nappa Siena  Socket: Marmor Verde Guatemala Säule: Nappa Verde

# CONTESSA 1956

Design: Wittmann Workshop

26590

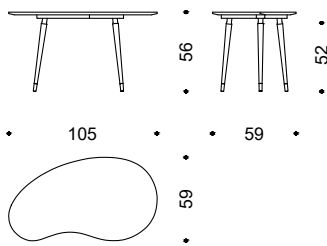

26590

**WxDxH (leg room) in cm:** 105x59x56(52)  
**BxTxH (Beinfreiheit) in cm:**

**WxDxH (leg room) in inches:** 41,34x23,23x22,05(20,47)

## Configurations

**Tabletop:** Fenix Nero Ingo  
**Legs:** Beech solid Black  
**Foot base:** Stainless steel brushed  
Without surcharge: Brass polished

## Ausführungen

**Tischplatte:** Fenix Nero Ingo  
**Beine:** Buche massiv Schwarz  
**Fußabschluss:** Edelstahl gebürstet  
**Auf Wunsch:** Messing poliert



# DD TABLE Design: Jaime Hayon

25893

25892

25891

25890

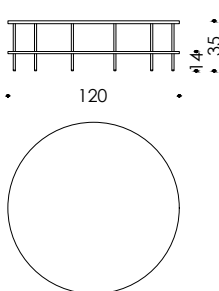
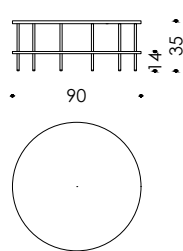
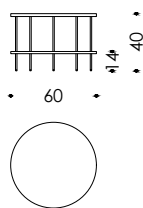
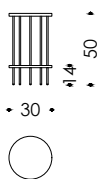

	25893	25892	25891	25890
<b>WxDxH (leg room) in cm:</b>	Ø30x50	Ø60x40	Ø90x35	Ø120x35
<b>BxTxH (Beinfreiheit) in cm:</b>				
<b>WxDxH (leg room) in inches:</b>	Ø11,81x19,69	Ø23,62x15,75	Ø35,43x13,78	Ø47,24x13,78

## Configurations

- upper tabletop:** Marble Nero Marquina
- Without surcharge: Marble Frappuccino, Emperador Dark or Carrara White
- lower tabletop:** leather covered in Color or Nappa
- Legs, columns:** Metal Bronze with felt glides
- Surcharge: Black Grey, Brass Satin Matt, Chrome, Black Chrome or 24k Gold plated

## Ausführungen

- obere Tischplatte:** Marmor Nero Marquina
- Auf Wunsch: Marmor Frappuccino, Emperador Dark oder Carrara White
- untere Tischplatte:** lederbezogen in Color oder Nappa
- Beine, Säule:** Metall Bronze mit Filzgleitern
- Aufpreis: Black Grey, Messing Satin Matt, Chrom, Schwarzchrom oder 24k vergoldet

# DETOUR

Design: Nendo

26390

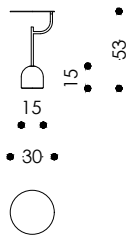

26390	
<b>WxDxH (leg room) in cm:</b>	Ø30x53
<b>BxTxH (Beinfreiheit) in cm:</b>	
<b>WxDxH (leg room) in inches:</b>	Ø11,81x20,87
<b>Configurations</b>	<b>Ausführungen</b>
<b>Tabletop:</b>	Metal Black Grey <i>Tischplatte: Metall Black Grey</i>
<b>Frame:</b>	Metal Black Grey <i>Gestell: Metall Black Grey</i>
<b>Base:</b>	Marble Nero Marquina on black metal plate with velvet pad <i>Sockel: Marmor Nero Marquina auf schwarzer Metallplatte mit Samtboden</i>

# GRAIN CUT TABLE Design: Jaime Hayon

25992

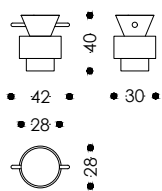

25992	
<b>WxDxH in cm:</b>	42x30x40
<b>BxTxH in cm:</b>	
<b>WxDxH in inches:</b>	16,54x11,81x15,75

Configurations		Ausführungen	
<b>Table:</b>	Ash solid Black	<b>Tisch:</b>	Esche massiv Schwarz
Surcharge:	In Wittmann standard RAL colours	<b>Aufpreis:</b>	In Wittmann Standard RAL Farben

# HELICE TABLE Design: Jaime Hayon

24780

Side view tabletop with leather pad/  
Seitenansicht Tischplatte mit Lederauflage

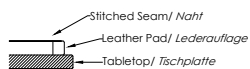
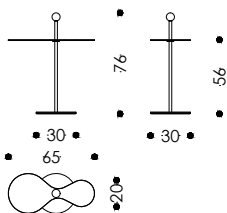

**Leather pad not mountable afterwards/ Lederauflage nachträglich nicht montierbar**

24780

**WxDxH (leg room) in cm:** 65x30x76  
**BxTxH (Beinfreiheit) in cm:**

**WxDxH (leg room) in inches:** 25,59x11,81x29,92

## Configurations

**Frame:** Metal Black Grey with felt glides and 24k Gold plated ball  
**Tabletop:** Metal Black Grey  
**Surcharge:** Fixed leather pad in Color or Nappa

## Ausführungen

**Gestell:** Metall Black Grey mit Filzgleitern und 24k vergoldeter Kugel  
**Tischplatte:** Metall Black Grey  
**Aufpreis:** Fixierte Lederauflage in Color oder Nappa

# LEATHER SIDE TABLE Design: Jaime Hayon

25990

25991



45

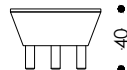

40

• 30 •

• 60 •

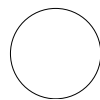

	25990	25991
<b>WxDxH (leg room) in cm:</b>	Ø30x45	Ø60x40
<b>BxTxH (Beinfreiheit) in cm:</b>		
<b>WxDxH (leg room) in inches:</b>	Ø11,81x17,72	Ø23,62x15,75

## Configurations

**Frame:** Wooden construction with felt glides, leather covered in Color or Nappa

**Tabletop:** Marble Nero Marquina

Without surcharge: Marble Frappuccino, Emperador Dark or Carrara White

## Ausführungen

**Gestell:** Holzkonstruktion mit Filzgleitern, lederbezogen in Color oder Nappa

**Tischplatte:** Marmor Nero Marquina

*Auf Wunsch:* Marmor Frappuccino, Emperador Dark oder Carrara White

# MERWYN

Design: Sebastian Herkner

29390

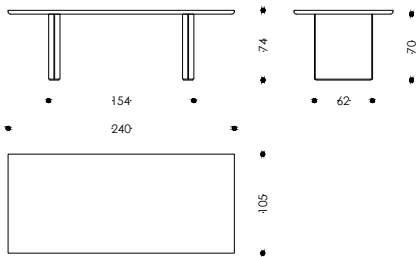

29391

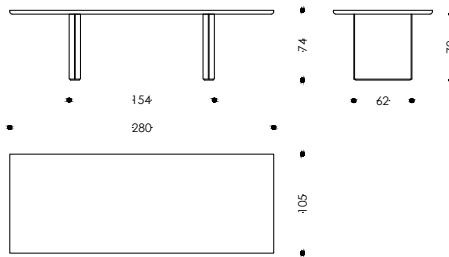

29392

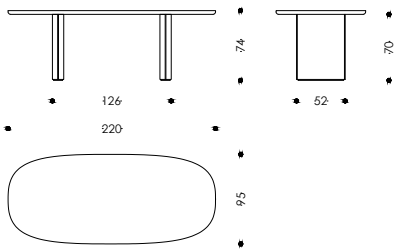

	29390	29391	29392
<b>WxDxH (leg room) in cm:</b>			
<b>BxTxH (Beinfreiheit) in cm:</b>	240x105x74(70)	280x105x74(70)	220x95x74(70)
<b>WxDxH (leg room) in inches:</b>	94,49x41,34x29,13(27,56)	110,24x41,34x29,13(27,56)	86,61x37,40x29,13(70)

## Configurations

<b>Legs:</b>	Wooden construction with black foot base and felt glides, covered in leather
<b>Cover (Legs):</b>	Fixed cover with piping
<b>Piping:</b>	Same as cover
<b>Without surcharge:</b>	Leather in standard colours Color Atlantic, Black, Cognac, Dark grey, Mocca, Sand, Siena and Taupe
<b>Tabletop:</b>	Oak solid, brushed
<b>Surcharge:</b>	Walnut solid

## Ausführungen

<b>Beine:</b>	Holzkonstruktion mit schwarzem Fußabschluss und Filzgleitern, lederbezogen
<b>Bezug (Beine):</b>	Fixbezug mit Keder
<b>Keder:</b>	Wie Bezug
<b>Auf Wunsch:</b>	Leder in Standardfarben Color Atlantic, Black, Cognac, Dark grey, Mocca, Sand, Siena und Taupe
<b>Tischplatte:</b>	Eiche massiv, gebürstet
<b>Aufpreis:</b>	Nuss massiv

# MILES Design: Sebastian Herkner

29890

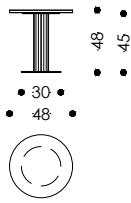

29891

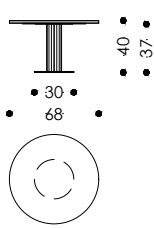

29896

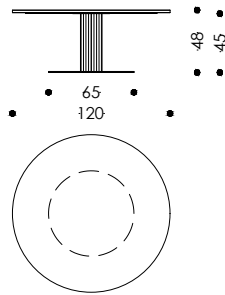

29892

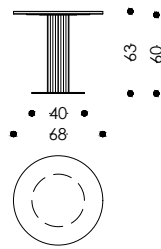

29895

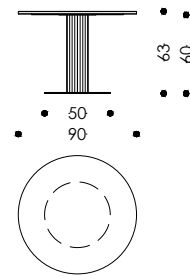

	29890	29891	29896	29892	29895
<b>WxDxH (leg room) in cm:</b>	Ø48x48(45)	Ø68x40(37)	Ø120x48(45)	Ø68x63(60)	Ø90x63(60)
<b>BxTxH (Beinfreiheit) in cm:</b>					
<b>WxDxH (leg room) in inches:</b>	Ø18,90x18,90(17,72)	Ø26,77x15,75(14,57)	Ø47,24x18,90(17,72)	Ø26,77x24,80(23,62)	Ø35,43x24,80(23,62)

## Configurations

<b>Base plate:</b>	Metal Black Grey with felt glides
<b>Surcharge:</b>	Brass Satin Matt
<b>Columns:</b>	Metal Black Grey
<b>Surcharge:</b>	Brass Satin Matt or leather covered in Color or Nappa
<b>Tabletop:</b>	Oak solid
<b>Surcharge:</b>	Marble Nero Marquina, White Carrara, Emperador Dark or Frappuccino

## Ausführungen

<b>Bodenplatte:</b>	Metall Black Grey mit Filzgleitern
<b>Aufpreis:</b>	Messing Satin Matt
<b>Säule:</b>	Metall Black Grey
<b>Aufpreis:</b>	Messing Satin Matt oder lederbezogen in Color oder Nappa
<b>Tischplatte:</b>	Eiche massiv
<b>Aufpreis:</b>	Marmor Nero Marquina, White Carrara, Emperador Dark oder Frappuccino

# MILES Design: Sebastian Herkner

29893

29894

29897

29898

29899

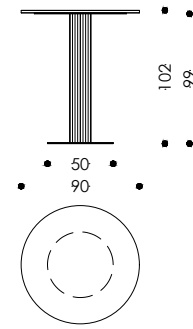
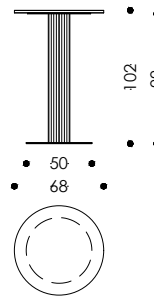
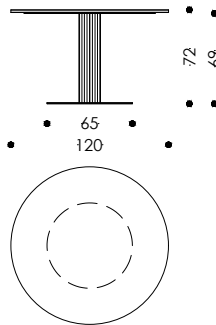
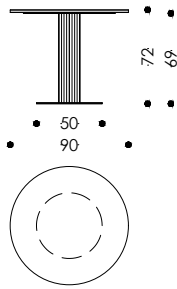
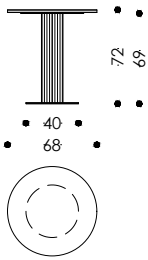

	29893	29894	29897	29898	29899
<b>WxDxH (leg room) in cm:</b>					
<b>BxTxH (Beinfreiheit) in cm:</b>	Ø68x72(69)	Ø90x72(69)	Ø120x72(69)	Ø68x102(99)	Ø90x102(99)
<b>WxDxH (leg room) in inches:</b>	Ø26,77x28,35(27,17)	Ø35,43x28,35(27,17)	Ø47,24x28,35(27,17)	Ø26,77x40,16(38,98)	Ø35,43x40,16(38,98)

## Configurations

<b>Base plate:</b>	Metal Black Grey with felt glides
<b>Surcharge:</b>	Brass Satin Matt
<b>Columns:</b>	Metal Black Grey
<b>Surcharge:</b>	Brass Satin Matt or leather covered in Color or Nappa
<b>Tabletop:</b>	Oak solid
<b>Surcharge:</b>	Marble Nero Marquina, White Carrara, Emperador Dark or Frappuccino

## Ausführungen

<b>Bodenplatte:</b>	Metall Black Grey mit Filzgleitern
<b>Aufpreis:</b>	Messing Satin Matt
<b>Säule:</b>	Metall Black Grey
<b>Aufpreis:</b>	Messing Satin Matt oder Lederbezogen in Color oder Nappa
<b>Tischplatte:</b>	Eiche massiv
<b>Aufpreis:</b>	Marmor Nero Marquina, White Carrara, Emperador Dark oder Frappuccino



# PARADISE BIRD

Design: Luca Nichetto

26440

26441

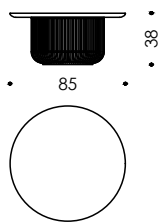
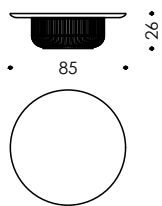

	26440	26441
<b>WxDxH (leg room) in cm:</b>		
<b>BxTxH (Beinfreiheit) in cm:</b>	Ø85x26	Ø85x38
<b>WxDxH (leg room) in inches:</b>	Ø33,46x10,24	Ø33,46x14,96

## Configurations

<b>Frame:</b>	Metal Black Grey with felt glides
Surcharge:	Brass Satin Matt or Soft Copper
<b>Tabletop:</b>	Walnut veneer
Surcharge:	Marble Frappuccino

## Ausführungen

<b>Gestell:</b>	Metall Black Grey mit Filzgleitern
Aufpreis:	Messing Satin Matt oder Soft Copper
<b>Tischplatte:</b>	Nuss furniert
Aufpreis:	Marmor Frappuccino

# PARADISE BIRD

Design: Luca Nichetto

26443 (R)/ 26442 (L)

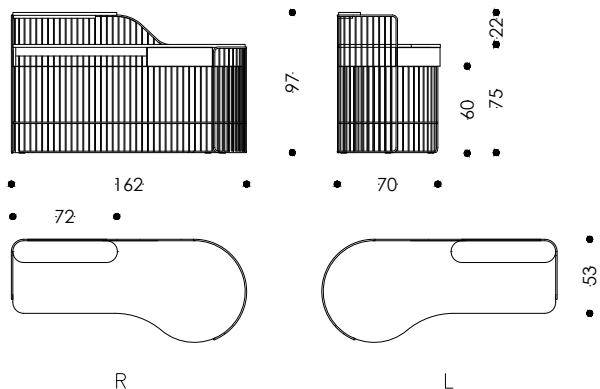

26443/ 26442	
<b>WxDxH (leg room) in cm:</b>	162x70x97
<b>BxTxH (Beinfreiheit) in cm:</b>	
<b>WxDxH (leg room) in inches:</b>	63,78x27,56x38,19
<b>Configurations</b>	
<b>Frame:</b>	Metal Black Grey with felt glides
<b>Surcharge:</b>	Brass Satin Matt or Soft Copper
<b>Corpus:</b>	Wooden construction, drawer with soft-close mechanism
<b>Tray-, Tabletop:</b>	Top surface in Fenix Nero Ingo
<b>Side surfaces, Drawer front:</b>	Walnut veneer
<b>Without surcharge:</b>	Ash Black veneer
<b>Ausführungen</b>	
<b>Gestell:</b>	Metall Black Grey mit Filzgleitern
<b>Aufpreis:</b>	Messing Satin Matt oder Soft Copper
<b>Korpus:</b>	Holzkonstruktion, Schublade mit Soft-Close Mechanismus
<b>Ablage-, Tischplatte:</b>	Oberfläche in Fenix Nero Ingo
<b>Seitenflächen, Schublade Front:</b>	Nuss furniert
<b>Auf Wunsch:</b>	Esche Schwarz furniert

# PARADISE BIRD OUTDOOR

Design: Luca Nichetto

27590

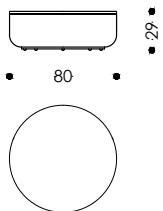

27590

**WxDxH in cm:**

Ø80x29

**BxTxH in cm:**

**WxDxH in inches:**

Ø31,50x11,42

## Configurations

<b>Frame:</b>	Aluminium construction woven with ropes, plastic glides produced in partnership with Ethimo
<b>Corpus:</b>	Lava Grey
Without surcharge:	Light Grey or Lava&Light Grey
<b>Tabletop:</b>	Lavastone Ardesia
<b>Rain Cover:</b>	Ethi-Care Fabric, Light grey

## Ausführungen

<b>Gestell:</b>	Aluminiumkonstruktion mit Seilen gewebt, Kunststoffgleiter produziert in Partnerschaft mit Ethimo
<b>Korpus:</b>	Lava Grey
Auf Wunsch:	Light Grey oder Lava&Light Grey
<b>Tischplatte:</b>	Lavastein Ardesia
<b>Abdeckhaube:</b>	Ethi-Care Stoff, Hellgrau

# SATZTISCHE Recreation Josef Hoffmann (Design: ca. 1900)

8890

Dimension of single tables / *Maße von Einzeltischen*

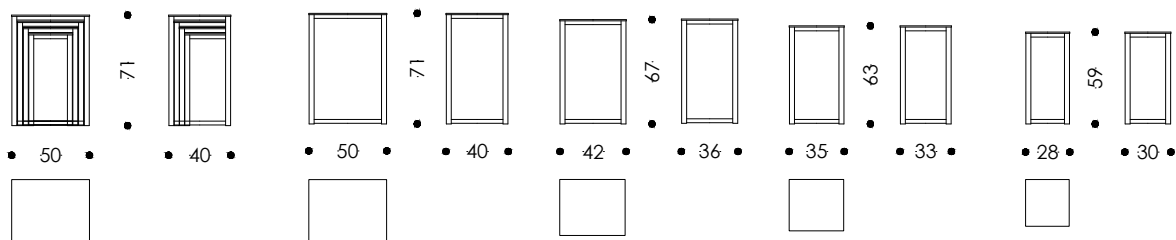

Side view of nesting tables / *Seitenansicht von Satz-tischen*

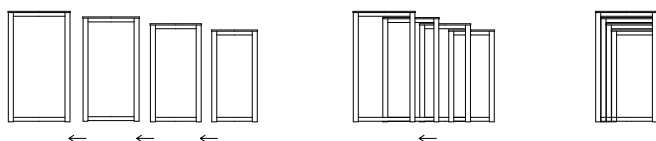

Order placement of single tables not possible / *Bestellung von Einzeltischen nicht möglich*

8890

**WxDxH (leg room) in cm:** 50x40x71

**BxTxH (Beinfreiheit) in cm:**

**WxDxH (leg room) in inches:** 19,67x15,75x27,95

## Configurations

**Frame:** Ash solid Black  
**Tabletop:** Ash Black veneer

## Ausführungen

**Gestell:** Esche massiv Schwarz  
**Tischplatte:** Esche Schwarz furniert

# STICKS TABLE Design: Jaime Hayon

24782

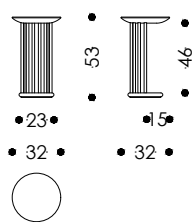

24781

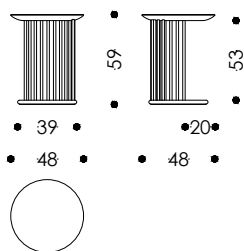

	24782	24781
<b>WxDxH (leg room) in cm:</b>	Ø32x53	Ø48x59
<b>BxTxH (Beinfreiheit) in cm:</b>		
<b>WxDxH (leg room) in inches:</b>	Ø12,60x20,87	Ø18,90x23,23

## Configurations

**Table:** Ash solid Black with felt glides  
**Surcharge:** In Wittmann standard RAL colours

## Ausführungen

**Tisch:** Esche massiv Schwarz mit Filzgleitern  
**Aufpreis:** In Wittmann Standard RAL Farben

# TUKY

Design: Luca Nichetto

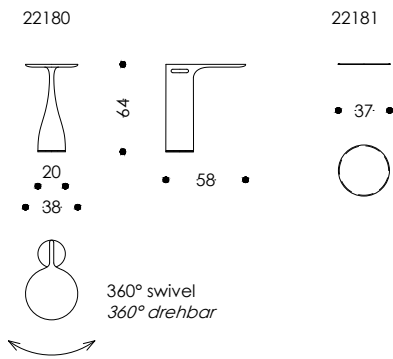

	22180	22181
<b>WxDxH in cm (Weight):</b>	38x58x64 (18kg)	Ø37
<b>BxTxH in cm (Gewicht):</b>		
<b>WxDxH (leg room) in inches:</b>	14,96x22,83x25,20	Ø14,57
<b>Max. edge load:</b>		
<b>Max. Randbelastung:</b>	3kg	

## Configurations

<b>Base:</b>	Black swivel metal plate
<b>Table:</b>	Ash solid Black with built-in magnets for leather pad fixation
<b>Surcharge:</b>	In Wittmann standard RAL colours
<b>Leather pad:</b>	leather covered in Color or Nappa

## Ausführungen

<b>Basis:</b>	Metalldrehteller Schwarz
<b>Tisch:</b>	Esche massiv Schwarz mit eingebauten Magneten zur Befestigung der Lederauflage
<b>Aufpreis:</b>	In Wittmann Standard RAL Farben
<b>Lederauflage:</b>	Lederbezogen in Color oder Nappa

# ACACIA

Design: Luca Nichetto

26492

26493

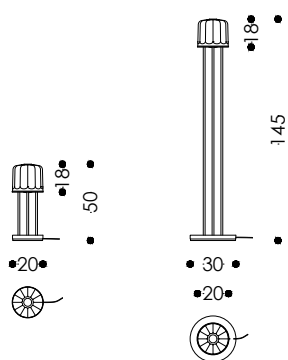

	26492	26493
<b>WxDxH in cm:</b>	Ø20x50	Ø30x145
<b>BxTxH in cm:</b>		
<b>WxDxH in inches:</b>	Ø7,87x19,69	Ø11,81x57,09

## Configurations

<b>Frame:</b>	Black Chrome
<b>Lamp shade:</b>	Murano Glass Grey/ Fumé
Without surcharge:	Murano Glass Verde
<b>Socket/ Light source:</b>	Customised LED bulb, dimmable
Table Lamp:	15,5W, 410lm
Floor Lamp:	15,5W, 1000lm
<b>Certification:</b>	CE (currently only available for EU and CH)

## Ausführungen

<b>Gestell:</b>	Schwarzchrom
<b>Lampenschirm:</b>	Murano Glas Grey/ Fumé
Auf Wunsch:	Murano Glas Verde
<b>Fassung/ Leuchtmittel:</b>	LED Sonderleuchtmittel, dimmbar
Tischleuchte:	15,5W, 410lm
Stehleuchte:	15,5W, 1000lm
<b>Zertifizierung:</b>	CE (derzeit nur für EU und CH verfügbar)

# ANTIGUA Design: Luca Nichetto

86301

86302

86303

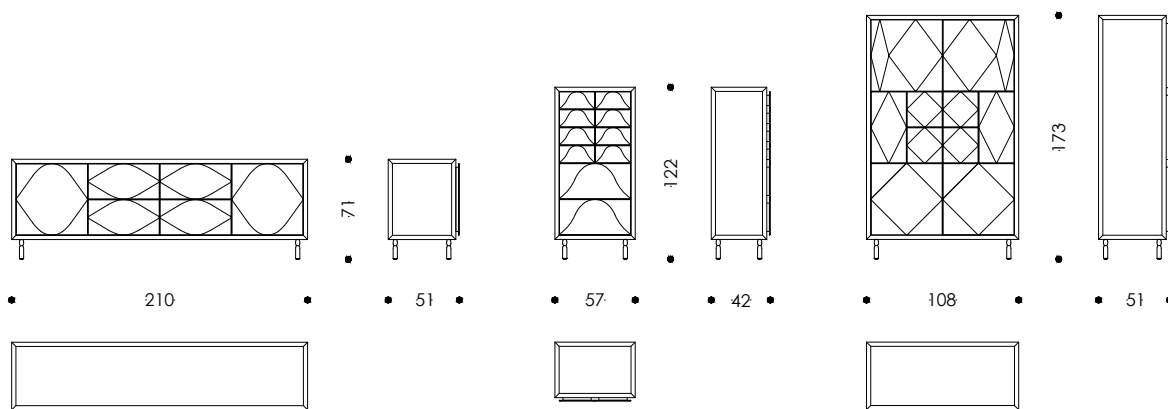

	86301	86302	86303
<b>WxDxH in cm:</b>	210x51x71	57x42x122	108x51x173
<b>BxTxH in cm:</b>			
<b>WxDxH in inches:</b>	82,68x20,08x27,95	22,44x16,54x48,03	42,52x20,08x68,11

## Configurations

<b>Frame:</b>	Frame in Walnut solid, corpus Ash veneer
<b>Drawers:</b>	Construction in Walnut solid with soft-close mechanism, front same as corpus with leather-covered handles
<b>Corpus, Fronts:</b>	Ash veneer Traffic White
Without surcharge:	Ash veneer Sand Yellow or Pigeon Blue
<b>Handles:</b>	Leather Color Black
Without surcharge:	Leather Color Mokka or Sand
<b>Feet:</b>	Metal Soft Copper

## Ausführungen

<b>Gestell:</b>	Korpusrahmen in Nuss massiv, Korpus Esche furniert
<b>Schubladen:</b>	Konstruktion in Nuss massiv mit Soft-Close Mechanismus, Front wie Korpus mit lederbezogenen Griffen
<b>Korpus, Fronten:</b>	Esche furniert Verkehrsweiß
Auf Wunsch:	Esche furniert Sandgelb oder Taubenblau
<b>Griffe:</b>	Leder Color Black
Auf Wunsch:	Leder Color Mokka oder Sand
<b>FüÙe:</b>	Metall Soft Copper



# BATON Design: Neri&Hu

24993

24992

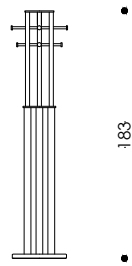
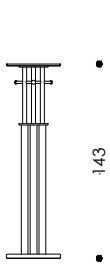

• 40 •

• 40 •



Perspective View/ *Perspektivansicht*

24993

24992

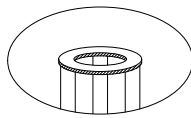
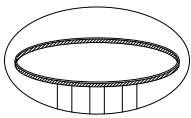

Bowl-shaped tray/  
*Ablage schalenförmig*

Metal ring/ *Metallring*

	24993	24992
<b>WxDxH in cm:</b>	Ø40x143	Ø40x183
<b>BxTxH in cm:</b>		
<b>WxDxH in inches:</b>	Ø15,75x56,30	Ø15,75x72,05

## Configurations

<b>Frame:</b>	Metal Black Grey, lower columns covered in leather
<b>Base:</b>	Marble on black metal plate with felt glides
<b>Variants:</b>	Base: Marble Nero Marquina Lower columns: Nappa Schwarz  Base: Marble Nero Marquina Lower columns: Nappa Siena  Base: Marble Verde Guatemala Lower columns: Nappa Verde

## Ausführungen

<b>Gestell:</b>	Metall Black Grey, untere Säule lederbezogen
<b>Sockel:</b>	Marmor auf schwarzer Metallplatte mit Filzgleitern
<b>Variante:</b>	Sockel: Marmor Nero Marquina Untere Säule: Nappa Schwarz  Sockel: Marmor Nero Marquina Untere Säule: Nappa Siena  Sockel: Marmor Verde Guatemala Untere Säule: Nappa Verde

# DETOUR Design: Nendo

26391

26392

26393

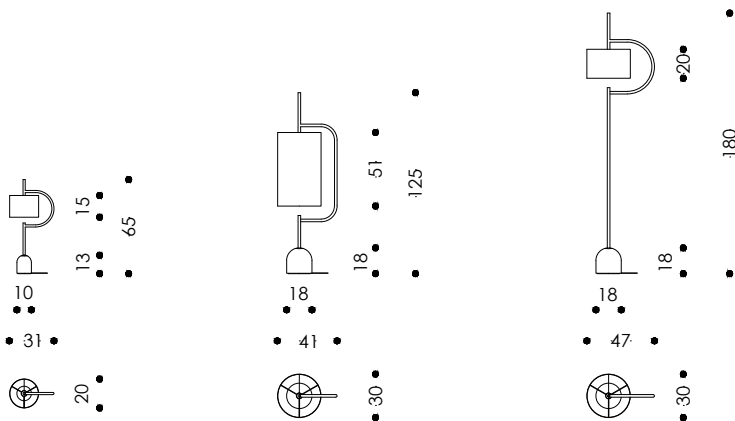

Light bulbs not included/ Leuchtmittel nicht im Lieferumfang enthalten

	26391	26392	26393
<b>WxDxH in cm:</b>			
<b>BxTxH in cm:</b>	31x20x65	41x30x125	47x30x180
<b>WxDxH in inches:</b>	12,20x7,87x25,59	16,14x11,81x49,21	18,50x11,81x70,87

## Configurations

**Frame:** Metal Black Grey  
**Lamp shade:** White textile, film-coated inside  
**Base:** Marble Nero Marquina on black metal plate with velvet pad, dimmer connected with black textile cable

## Socket/ Light source:

Table Lamp: E 14 LED 6,5W 806lm, 2700K DIMM  
 Floor Lamp: E 27 LED 10,5W 1055lm, 2700K DIMM  
**Certification:** IP 20 CE (currently only available for EU and CH)

## Ausführungen

**Gestell:** Metall Black Grey  
**Lampenschirm:** Weißes Textil, innen folienbeschichtet  
**Socket:** Marmor Nero Marquina auf schwarzer Metallplatte mit Samtboden, Dimmer mit schwarzem Textilkabel verbunden

## Fassung/ Leuchtmittel:

Tischleuchte: E 14 LED 6,5W 806lm, 2700K DIMM  
 Stehleuchte: E 27 LED 10,5W 1055lm, 2700K DIMM  
**Zertifizierung:** IP 20 CE (derzeit nur für EU und CH verfügbar)

# FORME Design: Arthur Arbesser

32503 (SELLA)

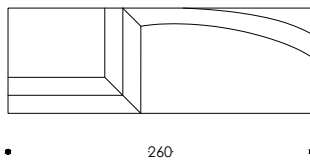

32504 (SELLA)

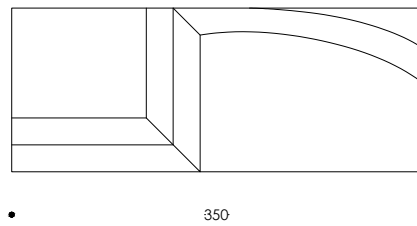

32501 (SCALA)

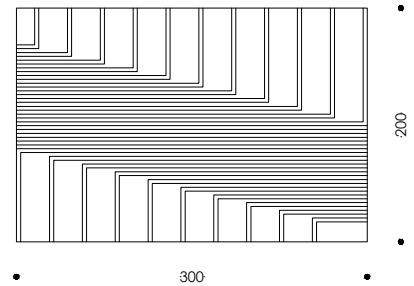

32502 (CHESS)

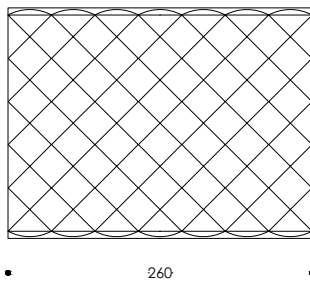

32505 (BLOCK)

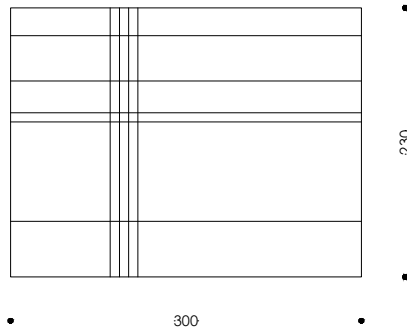

All rugs available in stated standard format as well as by square meters/  
*Alle Teppiche sind sowohl im Standardformat als auch nach Quadratmetern erhältlich*

	32503	32504	32501	32502	32505
<b>WxDxH in cm (Weight):</b>	260x90 (15kg)	350x140 (29kg)	300x200 (33kg)	260x200 (29kg)	300x230 (37kg)
<b>BxTxH in cm (Gewicht):</b>					
<b>WxDxH in inches:</b>	102,36x35,43	137,80x55,12	118,11x78,74	102,36x78,74	118,11x90,55
<b>Weight in pounds:</b>	33,07lb	63,93lb	72,75lb	63,93lb	81,57lb

## Configurations

**Production:** Hand-tufted in India, in partnership with cc-tapis

## Variants, Colours:

**SELLA:** Bianco, Nero & Oro: Ivory, black and gold  
**CHESS:** Azzurro & Grigio Verde: Blue and gray-green  
 Bianco & Nero: Black and white  
 Bordeaux & Azzurro: Wine-red and blue  
**SCALA:** Bianco Latte & Nero: Milk-white and black  
 Blu & Oro: Blue and gold  
**BLOCK:** Multicolour  
**Materials:** Wool; SCALA Blu & Oro: Wool and tencels

## Ausführungen

**Produktion:** Handgetuftet in Indien, in Partnerschaft mit cc-tapis

## Variante, Farben:

**SELLA:** Bianco, Nero & Oro: Ivory, Schwarz und Gold  
**CHESS:** Azzurro & Grigio Verde: Blau und Graugrün  
 Bianco & Nero: Schwarz und Weiß  
 Bordeaux & Azzurro: Bordeaux und Blau  
**SCALA:** Bianco Latte & Nero: Milchweiß und Schwarz  
 Blu & Oro: Blau und Gold  
**BLOCK:** Mehrfärbig  
**Materialien:** Wolle; SCALA Blu & Oro: Wolle und Tencel

# MD SHELF

Design: Jaime Hayon

84901

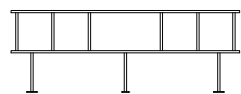

197



• 36 •



84902

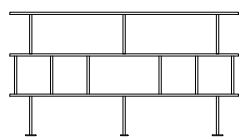

197

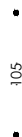

• 36 •



84903

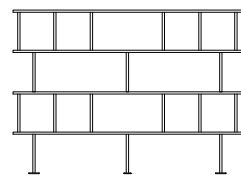

197



• 36 •



**Shelf height 140cm wall mounting necessary/ Regal Höhe 140cm Wandmontage erforderlich**

	84901	84902	84903
<b>WxDxH in cm:</b>	197x36x70	197x36x105	197x36x140
<b>BxTxH in cm:</b>			
<b>WxDxH in inches:</b>	77,56x14,17x27,56	77,56x14,17x41,34	77,56x14,17x55,12

## Configurations

<b>Frame:</b>	Metal Bronze with felt glides
<b>Surcharge:</b>	Black Grey or in Wittmann standard RAL colours
<b>Shelf panels:</b>	Leather covered in Nappa

## Ausführungen

<b>Gestell:</b>	Metall Bronze mit Filzgleitern
<b>Aufpreis:</b>	Black Grey oder In Wittmann Standard RAL Farben
<b>Regalböden:</b>	Lederbezogen in Nappa

# MONKEY MIRROR

Design: Jaime Hayon

25690

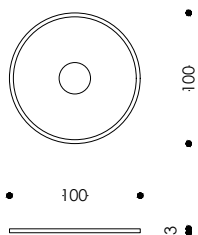

25691

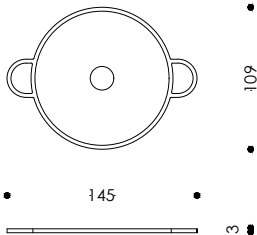

25692

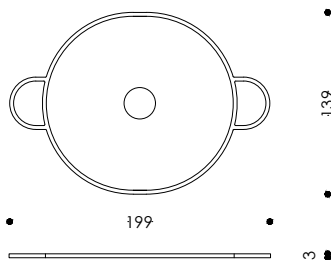

	25690	25691	25692
<b>WxDxH in cm:</b>	100x3x100	145x3x109	199x3x139
<b>BxTxH in cm:</b>			
<b>WxDxH in inches:</b>	39,37x1,18x39,37	57,09x1,18x42,91	78,35x1,18x54,72

## Configurations

**Frame:** Wooden frame, sepia brown  
 Without surcharge: In Wittmann standard RAL colours

## Ausführungen

**Rahmen:** Holzrahmen, Sepiabraun  
 Auf Wunsch: In Wittmann Standard RAL Farben

# OUVERT Design: Note

27390

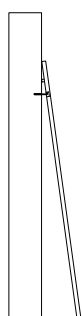
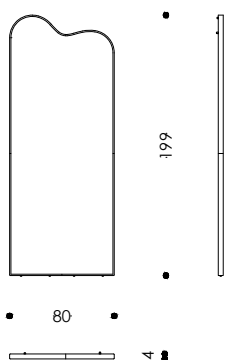

Mirror leaning/  
*Spiegel lehrend*



Mirror hanging/  
*Spiegel hängend*

The mirror can be leaned against the wall or hung on the wall/ *Der Spiegel kann an der Wand angelehnt oder hängend montiert werden*

27390

**WxDxH in cm:**

80x4x199

**BxTxH in cm:**

**WxDxH in inches:**

31,50x1,57x78,35

## Configurations

### Frame:

Wooden construction, frame covered in leather Nappa Mocca or Schwarz with plastic feet

## Ausführungen

### Rahmen:

Holzkonstruktion, Rahmen lederbezogen in Nappa Mocca oder Schwarz mit Kunststofffüßen

# TACT Design: Arthur Arbesser

9510

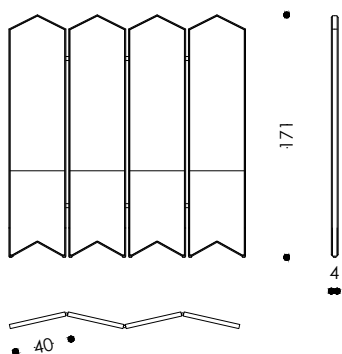

Configuration/ Ausführung

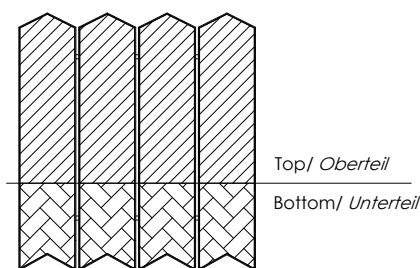

All panels are executed identically/  
Alle Paneele werden gleich ausgeführt

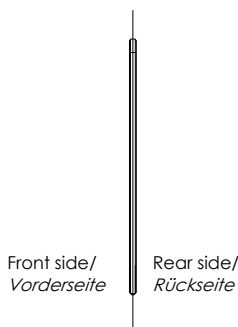

Front side and rear side can be executed in different colours/  
Vorderseite und Rückseite können andersfärbig ausgeführt werden

Due to material characteristics, leather Toro is not applicable/ Aufgrund der Materialeigenschaften ist Leder Toro ausgenommen

	9510
<b>WxDxH in cm (per panel):</b>	40x5x181
<b>BxTxH in cm (pro Paneele):</b>	
<b>WxDxH in inches (per panel):</b>	15,75x1,97x71,26

## Configurations

<b>Frame:</b>	Wooden construction of 4x upholstered panels with black hinges and height-adjustable plastic feet, frame covered in leather Nappa Schwarz
<b>Upholstery:</b>	Polyurethane foams with dacron overlay
<b>Cover:</b>	Covered in fabric or leather, all panels in same configuration
<b>Variants:</b>	
unicolour:	Top and bottom in same colour, Front side and rear side in same colour
multicolour:	Top and bottom in different colours and rear side in different colours

## Ausführungen

<b>Gestell:</b>	Holzkonstruktion aus 4x gepolsterten Paneelen mit schwarzen Scharnieren und höhenverstellbaren Kunststofffüßen, Rahmen lederbezogen in Nappa Schwarz
<b>Polsterung:</b>	Polymousse mit Vliesabdeckung
<b>Bezug:</b>	Stoff- oder lederbezogen; alle Paneele in gleicher Ausführung
<b>Variante:</b>	
einfärbig:	Oberteil und Unterteil gleichfärbig, Vorderseite und Rückseite gleichfärbig
mehrfärbig:	Oberteil und Unterteil andersfärbig und Rückseite andersfärbig

# Cushions/ Kissen

## Wittmann Standard Cushions/ Wittmann Standard Zierkissen

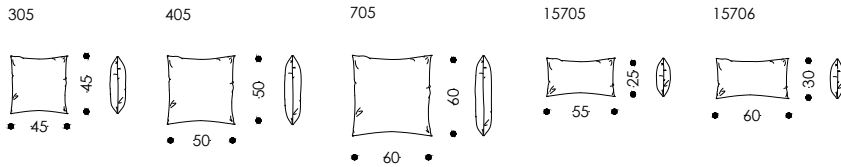

Combination Example/ *Kombinationsbeispiel*  
 1x BLOCKS Sofa 285/ *BLOCKS Sofa 285* (22220)  
 1x Cushion 45/ *Zierkissen 45* (305)  
 1x Cushion 55/ *Zierkissen 55* (15705)

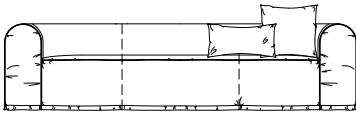

	305	405	705	15705	15706
<b>WxDxH in cm:</b>	45x45	50x50	60x60	55x25	60x30
<b>BxTxH in cm:</b>					
<b>WxDxH in inches:</b>	17,72x17,72	19,69x19,69	23,62x23,62	21,65x9,84	23,62x11,81

### Configurations

**Filling:** Feather filling with foam flakes  
**Cover:** Removable cover

### Ausführungen

**Füllung:** Federnfüllung mit Schaumstofflocken  
**Bezug:** Bezug abnehmbar

## BUN Cushions/ BUN Zierkissen

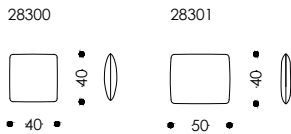

Combination Example/ *Kombinationsbeispiel*  
 1x BUN Sofa 160/ *BUN Sofa 160* (28320)  
 1x BUN Cushion square/ *BUN Zierkissen quadratisch* (28300)  
 1x BUN Cushion rectangular/ *BUN Zierkissen rechteckig* (28301)

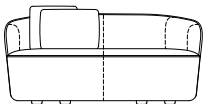

Combination Example/ *Kombinationsbeispiel*  
 1x BUN Lounge Chair/ *BUN Fauteuil* (28312)  
 1x BUN Cushion square/ *BUN Zierkissen quadratisch* (28300)

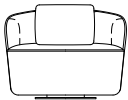

## VUELTA Cushions/ VUELTA Zierkissen

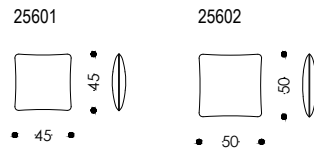

Combination Example/ *Kombinationsbeispiel*  
 1x VUELTA Lounge Sofa 298 L/ *VUELTA Lounge Sofa 298 L* (25635)  
 1x VUELTA Cushion 50/ *VUELTA Zierkissen 50* (25601)  
 2x VUELTA Cushion 45/ *VUELTA Zierkissen 45* (25602)

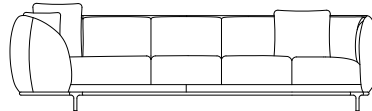

	28300	28301	25601	25602
<b>WxDxH in cm:</b>	40x40	50x40	45x45	50x50
<b>BxTxH in cm:</b>				
<b>WxDxH in inches:</b>	15,75x15,75	19,69x15,75	17,72x17,72	19,69x19,69

### Configurations

**Filling:** Feather filling with foam flakes  
**Cover:** Removable cover  
 BUN Cushions: Removable cover  
 VUELTA Cushions: Removable cover with piping

### Ausführungen

**Füllung:** Federnfüllung mit Schaumstofflocken  
**Bezug:** Bezug abnehmbar  
 BUN Zierkissen: Bezug abnehmbar  
 VUELTA Zierkissen: Bezug abnehmbar mit Keder



# INHALT / CONTENT

<b>Design Line</b>	Übersichtstabelle / Overview	145
Komplettbetten / <i>Complete beds</i>	Andes	146
	Joyce Cushion	147
	Joyce Niche	148
	Paradise Bird	149
	Wings	150
<b>Classic Line</b>	Übersichtstabelle / Overview	151
Komplettbetten / <i>Complete beds</i>	Caden	152
	Heather	153
	Metis Soft	154
	Stan	155
	Themis	156
<b>Advanced Line</b>	Übersichtstabelle / Overview	157
Kopfhäupter / <i>Headboards</i>	Alena	158
	Bryan	159
	Caden	160
	Heather	161
	Metis Soft	162
	Queens	163
	Regent	164
	Stan	165
	Themis	166
<b>Advanced Line</b>	Übersichtstabelle / Overview	167
Bettbasen / <i>Bed bases</i>	Frame	168
	Frame Slim	169
	Spring	170
	Spring Slim	171
<b>Einsätze</b>	Information	172
<i>Inserts</i>	Einreihenlattenrost / <i>Single-row-slatted frame</i>	173
	Comfort, Superior	174
	Motoren Einsatz / <i>Motor insert</i>	175
<b>Matratzen &amp; Auflagen</b>	Information	176
<i>Mattresses &amp; toppers</i>	Naturkautschuk / <i>Natural rubber</i>	177
	Sandmann Pocket 3	178
	Sandmann Deluxe Pocket	179
	Sandmann Imperial Pocket	181
	Zippverbindung / <i>Zipper</i>	183
	Matratzenauflage / <i>Topper Eden</i>	184
	Matratzenauflage / <i>Topper Princess</i>	185
	Matratzenauflagen / <i>Toppers</i>	186

## Design Line

Komplettbetten / *Complete Beds*



**Andes**



**Joyce Cushion**



**Joyce Niche**



**Paradise Bird**



**Wings**

## Classic Line

Komplettbetten / *Complete Beds*



**Caden**



**Heather**



**Metis Soft**



**Stan**



**Themis**

## Advanced Line

Kopfhäupter / *Headboards*



**Alena**



**Bryan**

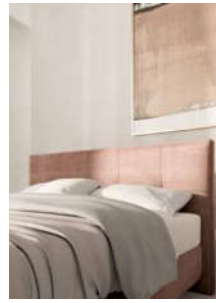

**Caden**

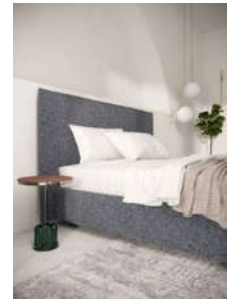

**Heather**



**Metis Soft**



**Queens**



**Regent**



**Stan**



**Themis**

## Advanced Line

Bettbasen / *Bed bases*



**Wittmann Frame**  
(mit Kopfhaupt Queens /  
*with headboard Queens*)



**Wittmann Frame Slim**  
(mit Kopfhaupt Bryan /  
*with headboard Bryan*)



**Wittmann Spring**  
(mit Kopfhaupt Caden /  
*with headboard Caden*)



**Wittmann Spring Slim**  
(mit Kopfhaupt Alena /  
*with headboard Alena*)

## Einsätze

*Inserts*



**Einreihen Lattenrost**  
*Single-row-slatted frame*



**Comfort**



**Superior**



**Motoren Einsatz**  
*Motor insert*

## Matratzen & Auflagen

*Mattresses & toppers*



**Naturkautschuk**  
*Natural rubber*



**Sandmann Pocket 3**



**Sandmann Deluxe Pocket**



**Sandmann Imperial Pocket**



**Matratzenauflage / Topper Eden**



**Matratzenauflage / Topper Princess**

# DESIGN LINE

## Komplettbetten / Complete Beds

S: Standard, A: Aufpreis / Surcharge, M: Minderpreis / Lowered price  
D: Durchgehend / Continuous, G: Geteilt / Split

ANDES (Bettbasis/Bed base: ANDES BOXSPRING)  
PARADISE BIRD (Bettbasis/Bed base: WITTMANN FRAME)  
WINGS (Bettbasis/Bed base: WITTMANN SPRING)  
JOYCE CUSHION (Bettbasis/Bed base: JOYCE FRAME)  
JOYCE NICHE (Bettbasis/Bed base: JOYCE FRAME)

### Ausführung / Configuration

<sup>1</sup> Kopfhauptbreite entspricht Bettbasisbreite mit Ausnahme Bettbasisbreite 90 cm, US Queen Size und US King Size  
Headboard width is equal to bed base width, except for 90 cm, US Queen Size and US King Size bed bases.  
<sup>2</sup> Auch in US Queen und US King Länge verfügbar.  
Also available in US Queen and US King length.

Bezug / Covering	Kopfhaupt & Basis / Headboard & base				
Kopfhaupt Rückseite bezogen (statt Drell) / Headboard reverse covered (instead of drill)	S	S	S	S	S
Kopfhaupt Bezug fix / Headboard fixed cover			S	S	S
Kopfhaupt Bezug abnehmbar / Headboard removable cover	S	S			
Bettbasis Bezug fix / Bed base fixed cover				S	S
Bettbasis Bezug abnehmbar / Bed base removable cover	S	S	S		
<b>Fußhöhe / Foot height</b>					
Fußhöhe 8 cm / Foot height 8 cm		S	S		
Fußhöhe 13 cm / Foot height 13 cm	S				
Fußhöhe 16 cm / Foot height 16 cm			S		
Fußhöhe 17 cm / Foot height 17 cm	S				
Fußhöhe 20 cm / Foot height 20 cm				S	S
<b>Fuß / Foot</b>					
Rundrohrfuß 8 cm / Tubular foot 8 cm					
Sichtfuß 8 cm / Visible foot 8 cm					
Sichtfuß 16 cm / Visible foot 16 cm					
Kufe (schwebend) 8 cm oder 16 cm / Runner (floating) 8 cm or 16 cm			S		
JOYCE Fuß 20 cm / JOYCE foot 20 cm				S	S
ANDES Fuß 13 cm oder 17 cm / ANDES foot 13 cm or 17 cm	S				
Sockel 8 cm / Plinth base 8 cm		S			
<b>Ablage / Bedside tray</b>					
Links/rechts (Holz oder Marmor) / Left/right (wood or marble)		S			
Links/rechts (Holz lederbezogen) / Left/right (wood leather covered)			S		
<b>Kopfhaupthöhe, -montage / Headboard height, mounting</b>					
Höhe 100 cm (JOYCE CUSHION 68 cm, JOYCE NICHE 82 cm) Height 100 cm (JOYCE CUSHION 68 cm, JOYCE NICHE 82 cm)	S			S	S
Höhe 120 cm / Height 120 cm		S	S		
Basis Unterkante bündig / Lower edge flush with base	S			S	S
Bodenstehend / Floorstanding		S	S		
<b>Kopfhauptbreite / Headboard width</b>					
Breite 40 cm / Width 40 cm					
Breite 100 cm / Width 100 cm					
Breite 120 cm / Width 120 cm					
Breite 140 cm / Width 140 cm					
Breite 160 cm / Width 160 cm	S	S	S	S	S
Breite 180 cm / Width 180 cm	S	S	S	S	S
Breite 200 cm / Width 200 cm	S	S	S	S	S
<b>Bettbasisbreite <sup>1</sup> / Bed base width <sup>1</sup> (Matratzenmaß / Mattress dimensions)</b>					
Breite 90 cm (Kopfhaupt 100 cm) / Width 90 cm (headboard 100 cm)					
Breite 100 cm / Width 100 cm					
Breite 120 cm / Width 120 cm					
Breite 140 cm / Width 140 cm					
US Queen Size 153x203 cm (Kopfhaupt 160 cm, JOYCE & ANDES bündig) US Queen Size 153x203 cm (headboard 160 cm, JOYCE & ANDES flush)	D	D	D	D	D
Breite 160 cm / Width 160 cm	D	D	D	D	D
Breite 180 cm / Width 180 cm	G	D	G	D	D
US King Size 193x203 cm (Kopfhaupt 200 cm, JOYCE & ANDES bündig) US King Size 193x203 cm (headboard 200 cm, JOYCE & ANDES flush)	G	D	G	D	D
Breite 200 cm / Width 200 cm	G	D	G	D	D
<b>Bettbasislänge <sup>2</sup> / Bed base length <sup>2</sup> (Matratzenmaß / Mattress dimensions)</b>					
Länge 200 cm / Length 200 cm	S	S	S	S	S
Länge 210 cm / Length 210 cm	S	S	S	S	S
<b>Einsatz, Unterfederung / Insert, substrate</b>					
Boxspring / Boxspring	S		S		
Comfort (160 cm durchgehend und geteilt, ab 180 cm geteilt) Comfort (160 cm continuous or split, from 180 cm split)		S		S	S
Superior (160 cm durchgehend und geteilt, ab 180 cm geteilt) Superior (160 cm continuous or split, from 180 cm split)		A		A	A
Motoren-Einsatz (160 cm durchgehend und geteilt, ab 180 cm geteilt) Motor insert (160 cm continuous or split, from 180 cm split)		A		A	A
Einreihen-Lattenrost (ab 160 cm geteilt, nicht für US Queen Size) Single-row-slatted frame (from 160 cm split, not for US Queen Size)		M		M	M

Anm.: Komplettbett exkludiert Matratzen  
Note: Complete bed excluding mattresses

# ANDES *Design: Luca Nichetto (2021)*

890XX

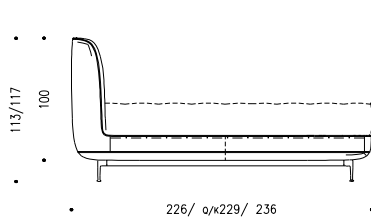

Einsetzkante  
Upper edge of insert

Basisoberkante  
Base Upper edge

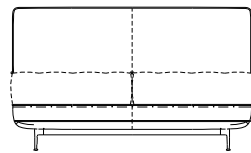

805

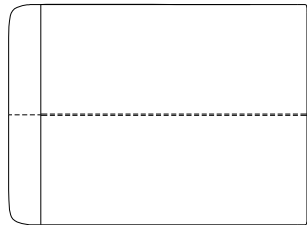
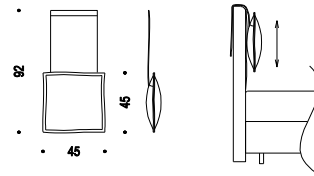

0153/160/180/k193/200

----- Teilungsnaht bei Leder oder Stoff Schnittkarte /  
Dividing seam for leather or fabric right way / off the bolt

• 34 / 38 •

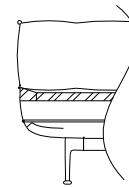

• 32 / 36 •

## Complete Bed

US King L 90,16 x W 75,98 x H 44,49/46,06 in  
US Queen L 90,16 x W 60,24 x H 44,49/46,06 in

## Base

US King Inside Frame L 79,92 x W 75,98 x H 12,60/14,17 in  
US Queen Inside Frame L 79,92 x W 60,24 x H 12,60/14,17 in

## Ausführungen:

<b>Kopfhauptkissen (KH):</b>	mit umlaufender Biese und Lappen mit Gegengewicht für stufenlose Höhenverstellung
Füllung	Federkissen
Bezug	Standard: Abnehmbar
<b>Basis:</b>	Andes Boxspring (Holzkonstruktion)
Breite	160, 180, 200 cm, US Queen, US King (Matratzenmaß)
Länge	200, 210 cm, US Queen, US King (Matratzenmaß)
Polsterung	Tonnentaschenfederkern, Polymousse, Vliesabdeckung
Bezug	Abnehmbar
Keder	Standard: wie Bezug oder Leder in den Standardfarben <sup>1</sup>
Einsatz	Boxspring
Fuß	Standard: Black grey
	Aufpreis: Messing satin matt
Fußhöhe	13, 17 cm
<b>Kopfhaupt:</b>	Holzkonstruktion
Breite	160, 180, 200 cm, US Queen, US King (Matratzenmaß)
Höhe	100 cm
Polsterung	Polymousse-Sandwichaufbau, Vliesabdeckung
Bezug	Abnehmbar
Rückseite	Wie Bezug
Kopfhauptmontage	Aufgesetzt auf Basis
Keder	Standard: wie Bezug oder Leder in den Standardfarben <sup>1</sup>

## Configurations:

<b>Headboard pillow (HB):</b>	With cording all around and flap with counterweight for continuous height adjustment
Füllung	Feather pillow
Cover	Standard: Removable
<b>Bed base:</b>	Andes Boxspring (wood construction)
Width	160, 180, 200 cm, US Queen, US King (mattress dimensions)
Length	200, 210 cm, US Queen, US King (mattress dimensions)
Upholstery	Pocket spring, polyfoam, fleece covered
Covering	Removable
Piping	Standard: same as cover or leather in standard colours <sup>1</sup>
Insert	Boxspring
Foot	Standard: Black Grey
	Surcharge: Brass Satin Matt
Foot height	13, 17 cm
<b>Headboard:</b>	Wood construction
Width	160, 180, 200 cm, US Queen, US King (mattress dimensions)
Height	100 cm
Upholstery	Polyfoam sandwich construction, fleece covered
Covering	Removable
Reverse	Same as cover
Headboard mounting	Mounted on base
Piping	Standard: same as cover or leather in standard colours <sup>1</sup>

<sup>1</sup> Standardfarben Leder: Color atlantic, black, cognac, dark grey, mocca, sand, siena and taupe

<sup>1</sup> Standard colours leather. Color atlantic, black, cognac, dark grey, mocca, sand, siena and taupe

Falten sind design- verarbeitungs-, material-, bzw. benützungsbedingt und stellen keinen Reklamationsgrund dar.  
Wrinkles may occur due to design, treatment, quality of material and conditions of use and are no cause for claims.

# JOYCE Cushion *Design: Soda Designers (2019)*

816XX

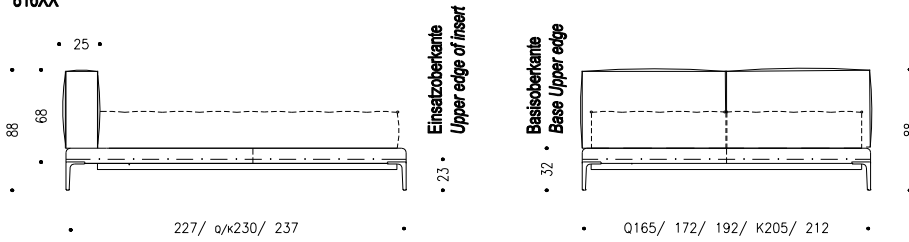

----- Teilungsnahat bei Leder oder Stoff Schnittkante /  
Dividing seam for leather or fabric right way / off the bolt

## Complete Bed

US King	L 90,55 x W 80,71 x H 34,65 in
US Queen	L 90,55 x W 64,96 x H 34,65 in

## Base

US King Inside Frame	L 79,92 x W 75,98 x H 9,06 in
US Queen Inside Frame	L 79,92 x W 60,24 x H 9,06 in

## Ausführungen:

<b>Basis:</b>	Joyce Rahmen (Metall-Holzkonstruktion schwarz pulverbeschichtet)
Breite	160, 180, 200 cm, US Queen, US King (Matratzenmaß)
Länge	200, 210 cm, US Queen, US King (Matratzenmaß)
Polsterung	Polymousse, Vliesabdeckung
Bezug	Fixbezug
Einsatz	Standard: Comfort <sup>1</sup>
Fuß	Standard: Bronze Aufpreis: Black Grey
Fußhöhe	20 cm
<b>Kopfhaupt:</b>	Holzkonstruktion
Breite	160, 180, 200 cm, US Queen, US King (Matratzenmaß)
Höhe	68 cm
Polsterung	Polymousse-Sandwichaufbau, Vliesabdeckung
Bezug	Fixbezug
Rückseite	Wie Bezug
Kopfhauptmontage	Aufgesetzt auf Basis

<sup>1</sup> Standardausführung. Varianten gegen Aufpreis erhältlich.

## Configurations:

<b>Bed base:</b>	Joyce Frame (metal and wood construction powder-coated black)
Width	160, 180, 200 cm, US Queen, US King (mattress dimensions)
Length	200, 210 cm, US Queen, US King (mattress dimensions)
Upholstery	Polyfoam, fleece covered
Covering	Fixed cover
Insert	Standard: Comfort <sup>1</sup>
Foot	Standard: Bronze Surcharge: Black Grey
Foot height	20 cm
<b>Headboard:</b>	Wood construction
Width	160, 180, 200 cm, US Queen, US King (mattress dimensions)
Height	68 cm
Upholstery	Polyfoam sandwich construction, fleece covered
Covering	Fixed cover
Reverse	Same as cover
Headboard mounting	Mounted on base

<sup>1</sup> Standard variant. Variants available for surcharge.

Falten sind design- verarbeitungs-, material-, bzw. benützungsbedingt und stellen keinen Reklamationsgrund dar.  
Wrinkles may occur due to design, treatment, quality of material and conditions of use and are no cause for claims.

# JOYCE Niche *Design: Soda Designers (2019)*

817XX

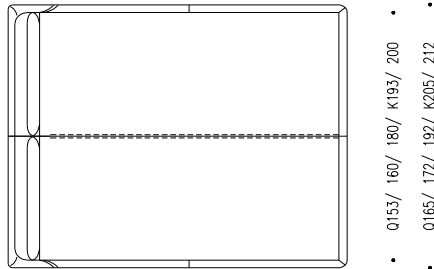
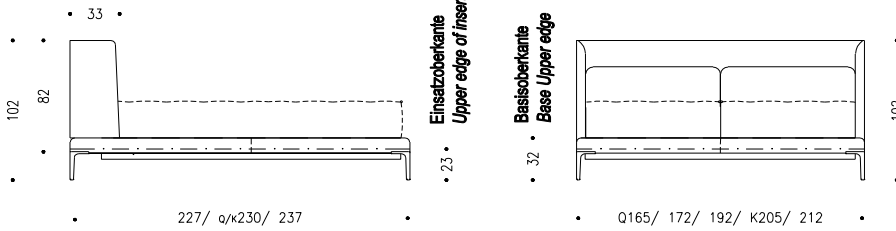

----- Teilungsnaht bei Leder oder Stoff Schnittkante /  
Dividing seam for leather or fabric right way / off the bolt

### Complete Bed

US King	L 90,55 x W 80,71 x H 40,16 in
US Queen	L 90,55 x W 64,96 x H 40,16 in

### Base

US King Inside Frame	L 79,92 x W 75,98 x H 9,06 in
US Queen Inside Frame	L 79,92 x W 60,24 x H 9,06 in

### Ausführungen:

<b>Basis:</b>	Joyce Rahmen (Metall-Holzkonstruktion schwarz pulverbeschichtet)
Breite	160, 180, 200 cm, US Queen, US King (Matratzenmaß)
Länge	200, 210 cm, US Queen, US King (Matratzenmaß)
Polsterung	Polymousse, Vliesabdeckung
Bezug	Fixbezug
Einsatz	Standard: Comfort <sup>1</sup>
Fuß	Standard: Bronze
Fußhöhe	Aufpreis: Black Grey 20 cm
<b>Kopfhaupt:</b>	Holzkonstruktion
Breite	160, 180, 200 cm, US Queen, US King (Matratzenmaß)
Höhe	82 cm
Polsterung	Polymousse-Sandwichaufbau, Vliesabdeckung
Bezug	Fixbezug
Rückseite	Wie Bezug
Kopfhaupt- montage	Aufgesetzt auf Basis

<sup>1</sup> Standardausführung. Varianten gegen Aufpreis erhältlich.

### Configurations:

<b>Bed base:</b>	Joyce Frame (metal and wood construction powder-coated black)
Width	160, 180, 200 cm, US Queen, US King (mattress dimensions)
Length	200, 210 cm, US Queen, US King (mattress dimensions)
Upholstery	Polyfoam, fleece covered
Covering	Fixed cover
Insert	Standard: Comfort <sup>1</sup>
Foot	Standard: Bronze
Foot height	Surcharge: Black Grey 20 cm
<b>Headboard:</b>	Wood construction
Width	160, 180, 200 cm, US Queen, US King (mattress dimensions)
Height	82 cm
Upholstery	Polyfoam sandwich construction, fleece covered
Covering	Fixed cover
Reverse	Same as cover
Headboard mounting	Mounted on base

<sup>1</sup> Standard variant. Variants available for surcharge.

Falten sind design- verarbeitungs-, material-, bzw. benützungsbedingt und stellen keinen Reklamationsgrund dar.  
Wrinkles may occur due to design, treatment, quality of material and conditions of use and are no cause for claims.



# PARADISE BIRD *Design: Luca Nichetto (2021)*

891XX

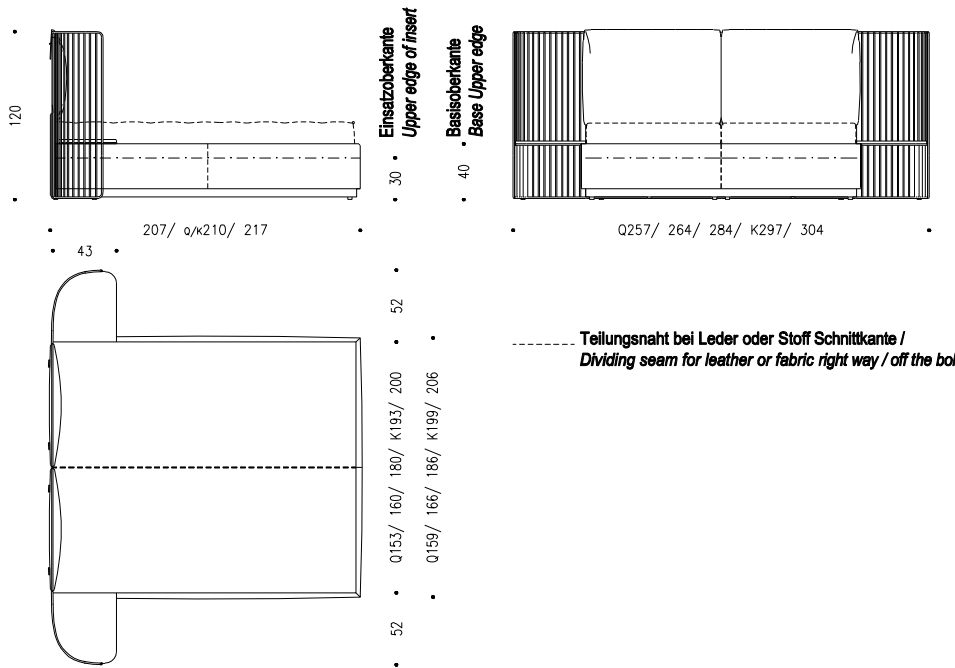

## Complete Bed

US King L 82,68 x W 116,93 x H 47,24 in  
US Queen L 82,68 x W 101,18 x H 47,24 in

## Base

US King Inside Frame L 79,92 x W 75,98 x H 11,81 in  
US Queen Inside Frame L 79,92 x W 60,24 x H 11,81 in

## Ausführungen:

<b>Basis:</b>	Wittmann Frame (Metall-Holzkonstruktion schwarz pulverbeschichtet)
Breite	160, 180, 200 cm, US Queen, US King (Matratzenmaß)
Länge	200, 210 cm, US Queen, US King (Matratzenmaß)
Polsterung	Polymousse, Vliesabdeckung
Bezug	Abnehmbar
Einsatz	Comfoteinsatz <sup>1</sup>
Sockel	Standard: Black Grey Aufpreis: Messing satin matt oder Soft copper
Sockelhöhe	8 cm
<b>Kopfhaupt:</b>	Drahtgestell (wie Sockel)
Breite	160, 180, 200 cm, US Queen, US King (Matratzenmaß)
Höhe	120 cm
Polsterung	Kissen (Federfüllung)
Bezug	nur der Bezug der Kopfhauptkissen ist abnehmbar, Unterteil des Kopfhauptes ist Fixbezug.
Rückseite	Wie Bezug
Kopfhauptmontage	Bodenstehend
Keder	Standard: wie Bezug oder Leder in den Standardfarben <sup>2</sup>
Ablage	Standard: Nuss massiv natur <sup>1</sup>

<sup>1</sup> Standardausführung. Varianten gegen Aufpreis erhältlich.

<sup>2</sup> Standardfarben Leder: Color atlantic, black, cognac, dark grey, mocca, sand, siena and taupe

## Configurations

<b>Bed base</b>	Wittmann Frame (metal and wood construction powder-coated black)
Width	160, 180, 200 cm, US Queen, US King (mattress dimensions)
Length	200, 210 cm, US Queen, US King (mattress dimensions)
Upholstery	Polyfoam, fleece covered
Covering	Removable
Insert	Standard: Comfort <sup>1</sup>
Plinth	Standard: Black Grey surcharge: Brass satin matt or soft copper
Plinth height	8 cm
<b>Headboard:</b>	Wire frame (same as plinth)
Width	160, 180, 200 cm, US Queen, US King (mattress dimensions)
Height	120 cm
Upholstery	Pillows (feather filling)
Covering	Only the cover of the head pillows is removable, the lower part of the head pillow is fixed covered.
Reverse	Same as cover
Headboard-mounting	Floorstanding
Piping	Standard: same as cover or leather in standard colours <sup>2</sup>
Bedside tray	Standard: Natural solid walnut <sup>1</sup>

<sup>1</sup> Standard variant. Variants available for surcharge.

<sup>2</sup> Standard colours leather: Color atlantic, black, cognac, dark grey, mocca, sand, siena and taupe

Falten sind design- verarbeitungs-, material-, bzw. benützungsbedingt und stellen keinen Reklamationsgrund dar.  
*Wrinkles may occur due to design, treatment, quality of material and conditions of use and are no cause for claims.*

# WINGS *Design: Jaime Hayon (2017)*

892XX

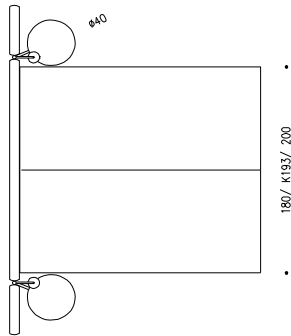
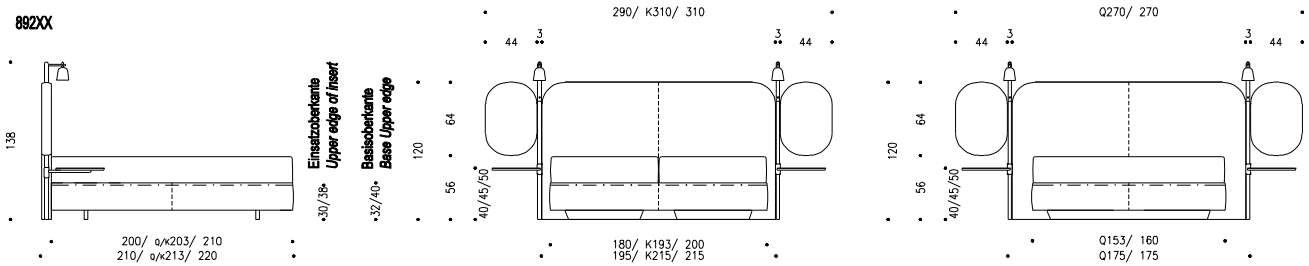

----- Teilungsnaht bei Leder oder Stoff Schnittkante /  
Dividing seam for leather or fabric right way / off the bolt

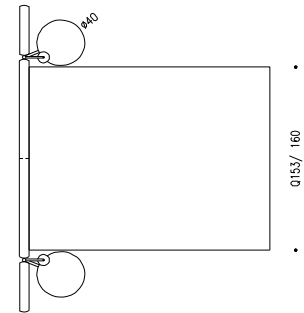

**Complete Bed**

US King L 83,86 x W 122,05 x H 54,33 in  
US Queen L 83,86 x W 106,90 x H 54,33 in

**Base**

US King Inside Frame L 79,92 x W 75,98 x H 11,81/14,96 in  
US Queen Inside Frame L 79,92 x W 60,24 x H 11,81/14,96 in

805

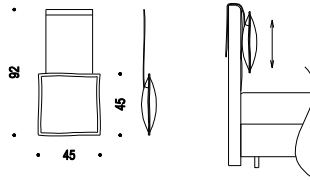

**Ausführungen:**

<b>Kopfhauptkissen (KH):</b>	mit umlaufender Biese und Lappen mit Gegengewicht für stufenlose Höhenverstellung
Füllung	Federkissen
Bezug	Standard: Abnehmbar
<b>Basis</b>	Wittmann Spring (Holzkonstruktion)
Breite	160, 180, 200 cm, US Queen, US King (Matratzenmaß)
Länge	200, 210 cm, US Queen, US King (Matratzenmaß)
Polsterung	Tonnentaschenfederkern, Polymousse, Vliesabdeckung
Bezug	Abnehmbar
Einsatz	Boxspring
Fuß	Kufe schwarz
Fußhöhe	8, 16 cm
<b>Kopfhaupt:</b>	Holzkonstruktion
Breite	160, 180, 200 cm (Matratzenmaß)
Höhe	120 cm
Polsterung	Polymousse-Sandwichaufbau, Vliesabdeckung
Bezug	Fixbezug
Rückseite	Wie Bezug
Kopfhauptmontage	Bodenstehend
Flügel	Schwenkbar
Stange	Metall Black grey
Leuchte	Metall Black grey, Leuchtmittel: LED Der LED-Spot ist schwenkbar
Ablage	Holz lederbezogen lt. Wittmann Nappa Kollektion schwenkbar und in drei Höhen wählbar 45cm (Standard) Auf Wunsch: 40, 50 cm

**Configurations:**

<b>Headboard pillow (HB):</b>	With cording all around and flap with counterweight for continuous height adjustment
Füllung	Feather pillow
Cover	Standard: Removable
<b>Bed base</b>	Wittmann Spring (wood construction)
Width	160, 180, 200 cm, US Queen, US King (mattress dimensions)
Length	200, 210 cm, US Queen, US King (mattress dimensions)
Upholstery	Pocket spring, polyfoam, fleece covered
Covering	Removable
Boxspring	Boxspring
Foot	Black runner
Foot height	8, 16 cm
<b>Headboard.</b>	Wood construction
Width	160, 180, 200 cm (mattress dimensions)
Height	120 cm
Upholstery	Polyfoam sandwich construction, fleece covered
Covering	Fixed cover
Reverse	Same as cover
<b>Headboard-mounting</b>	Floorstanding
<b>Wings</b>	Tilttable
<b>Mounting rod</b>	Powder-coated black grey
<b>Lights</b>	Powder-coated black grey, lights: LED The LED-spot can be swivelled
<b>Bedside tray</b>	Wood leather covered from the Wittmann Nappa Collector tilttable, available in three heights: 45cm (standard) on request: 40, 50 cm

Falten sind design- verarbeitungs-, material-, bzw. benützungsbedingt und stellen keinen Reklamationsgrund dar.  
Wrinkles may occur due to design, treatment, quality of material and conditions of use and are no cause for claims.

# CLASSIC LINE

## Komplettbetten / Complete Beds

S: Standard, A: Aufpreis / Surcharge, M: Minderpreis / Lowered price  
D: Durchgehend / Continuous, G: Geteilt / Split

	CADEN (Bettbasis/Bed base: WITTMANN SPRING)	HEATHER (Bettbasis/Bed base: WITTMANN SPRING)	METIS SOFT (Bettbasis/Bed base: WITTMANN SPRING)	STAN (Bettbasis/Bed base: WITTMANN SPRING)	THEMIS (Bettbasis/Bed base: WITTMANN SPRING)
<b>Bezug / Covering</b>	<b>Kopfhaupt &amp; Basis / Headboard &amp; base</b>				
Kopfhaupt Rückseite bezogen (statt Drell) / Headboard reverse covered (instead of drill)	S	S	S	S	S
Kopfhaupt Bezug fix / Headboard fixed cover	S	S	S	S	S
Kopfhaupt Bezug abnehmbar / Headboard removable cover		A			A
Bettbasis Bezug fix / Bed base fixed cover	S	S	S	S	S
Bettbasis Bezug abnehmbar / Bed base removable cover	A	A	A	A	A
<b>Fußhöhe / Foot height</b>					
Fußhöhe 8 cm / Foot height 8 cm	S	S	S	S	S
Fußhöhe 13 cm / Foot height 13 cm					
Fußhöhe 16 cm / Foot height 16 cm	S	S	S	S	S
Fußhöhe 17 cm / Foot height 17 cm					
Fußhöhe 20 cm / Foot height 20 cm					
<b>Füße / Feet</b>					
Rundrohrfuß 8 cm / Tubular foot 8 cm					
Sichtfuß 8 cm / Visible foot 8 cm					
Sichtfuß 16 cm / Visible foot 16 cm					
Kufe (schwebend) 8 cm oder 16 cm / Runner (floating) 8 cm or 16 cm	S	S	S	S	S
JOYCE Fuß 20 cm / JOYCE foot 20 cm					
ANDES Fuß 13 cm oder 17 cm / ANDES foot 13 cm or 17 cm					
Sockel 8 cm / Plinth base 8 cm					
<b>Ablage / Bedside tray</b>					
Links/rechts / Left/right					
Links/rechts / Left/right					
<b>Kopfhaupthöhe, -montage / Headboard height, mounting</b>					
Höhe 100 cm / Height 100 cm					
Höhe 120 cm (HEATHER 130 cm) / Height 120 cm (HEATHER 130 cm)	S	S	S	S	S
Basis Unterkante bündig / Lower edge flush with base	S	S	S	S	S
Bodenstehend / Floorstanding	S	S	S	S	S
<b>Kopfhauptbreite / Headboard width</b>					
Breite 40 cm / Width 40 cm					
Breite 100 cm / Width 100 cm					
Breite 120 cm / Width 120 cm					
Breite 140 cm / Width 140 cm					
Breite 160 cm / Width 160 cm	S	S	S	S	S
Breite 180 cm / Width 180 cm	S	S	S	S	S
Breite 200 cm / Width 200 cm	S	S	S	S	S
<b>Bettbasisbreite <sup>1</sup> / Bed base width <sup>1</sup> (Matratzenmaß / Mattress dimensions)</b>					
Breite 90 cm (Kopfhaupt 100 cm) / Width 90 cm (headboard 100 cm)					
Breite 100 cm / Width 100 cm					
Breite 120 cm / Width 120 cm					
Breite 140 cm / Width 140 cm					
US Queen Size 153x203 cm (Kopfhaupt 160 cm) / US Queen Size 153x203 cm (headboard 160 cm)	D	D	D	D	D
Breite 160 cm / Width 160 cm	D/G	D/G	D/G	D/G	D/G
Breite 180 cm / Width 180 cm	G	G	G	G	G
US King Size 193x203 cm (Kopfhaupt 200 cm) / US King Size 193x203 cm (headboard 200 cm)	G	G	G	G	G
Breite 200 cm / Width 200 cm	G	G	G	G	G
<b>Bettbasislänge <sup>2</sup> / Bed base length <sup>2</sup> (Matratzenmaß / Mattress dimensions)</b>					
Länge 200 cm / Length 200 cm	S	S	S	S	S
Länge 210 cm / Length 210 cm	S	S	S	S	S
<b>Einsatz, Unterfederung / Insert, substrate</b>					
Boxspring / Boxspring	S	S	S	S	S
Comfort (160 cm durchgehend und geteilt, ab 180 cm geteilt) Comfort (160 cm continuous or split, from 180 cm split)					
Superior (160 cm durchgehend und geteilt, ab 180 cm geteilt) Superior (160 cm continuous or split, from 180 cm split)					
Motoren-Einsatz (160 cm durchgehend und geteilt, ab 180 cm geteilt) Motor insert (160 cm continuous or split, from 180 cm split)					
Einreihen-Lattenrost (ab 160 cm geteilt, nicht für US Queen Size) Single-row-slatted frame (from 160 cm split, not for US Queen Size)					

Ausführung / Configuration

<sup>1</sup> Kopfhauptbreite entspricht Bettbasisbreite mit Ausnahme Bettbasisbreite 90 cm, US Queen Size und US King Size  
Headboard width is equal to bed base width, except for 90 cm, US Queen Size and US King Size bed bases.  
<sup>2</sup> Auch in US Queen und US King Länge verfügbar.  
Also available in US Queen and US King length.

Anm.: Komplettbett exkludiert Matratzen

Note: Complete bed excluding mattresses

897XX

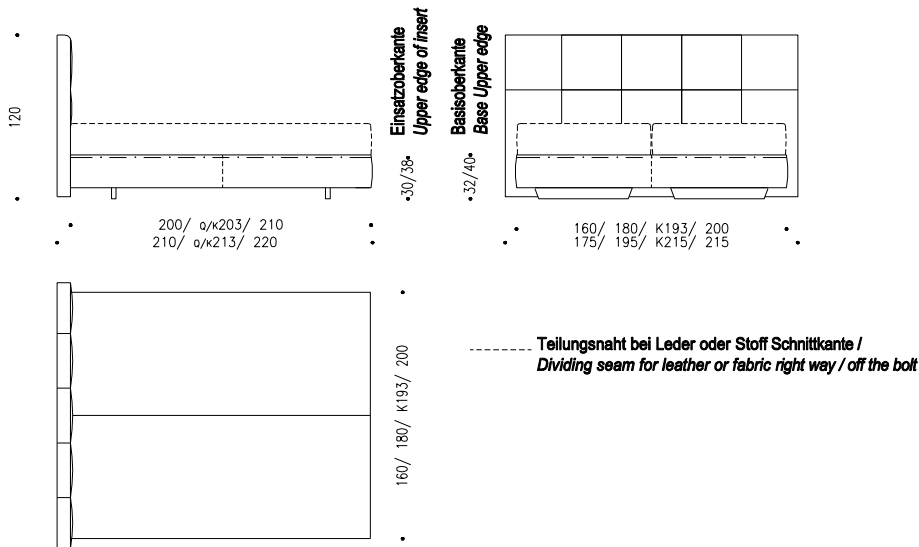

### Headboard

US King W 84,65 x D 3,94 x H 47,24 in  
US Queen W 68,90 x D 3,94 x H 47,24 in

### Base

US King Inside Frame L 79,92 x W 75,98 x H 11,81/14,96 in  
US King Outer Frame L 79,92 x W 75,98 x H 12,60/15,75 in

US Queen Inside Frame L 79,92 x W 60,24 x H 11,81/14,96 in  
US Queen Outer Frame L 79,92 x W 60,24 x H 12,60/15,75 in

805

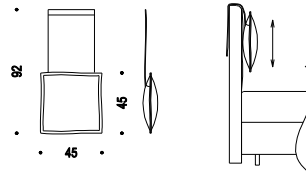

### Ausführungen:

**Kopfhauptkissen (KH):** mit umlaufender Biese und Lappen mit Gegengewicht für stufenlose Höhenverstellung  
Füllung Federkissen  
Bezug Standard: Abnehmbar  
Keder Standard: Farbe wie Bezug

**Basis:** Wittmann Spring (Holzkonstruktion)  
Breite 160, 180, 200 cm, US Queen, US King (Matratzenmaß) <sup>2</sup>

Länge 200, 210 cm, US Queen, US King (Matratzenmaß)  
Polsterung Tonnentaschenfederkern, Polymousse, Vliesabdeckung  
Bezug Fixbezug <sup>1</sup>  
Einsatz Boxspring  
Fuß Kufe schwarz  
Fußhöhe 8, 16 cm

**Kopfhaupt:** Holzkonstruktion  
Breite 160, 180, 200 cm (Matratzenmaß)  
Höhe 120 cm  
Polsterung Polymousse-Sandwichaufbau, Vliesabdeckung  
Bezug Fixbezug  
Rückseite Drell  
Kopfhauptmontage Bodenstehend oder bündig mit Basis

<sup>1</sup> Standardausführung. Varianten gegen Aufpreis erhältlich.

<sup>2</sup> Spring Basis: Breite 160 durchgehend oder geteilt; ab Breite 180 geteilt

### Configurations:

**Headboard pillow (HB):** With cording all around and flap with counterweight for continuous height adjustment  
Filling Feather pillow  
Cover Standard: Removable  
Piping Standard: Color same as cover

**Bed base:** Wittmann Spring (wood construction)  
Width 160, 180, 200 cm, US Queen, US King (mattress dimensions) <sup>2</sup>  
Length 200, 210 cm, US Queen, US King (mattress dimensions)  
Upholstery Pocket spring, polyfoam, fleece covered  
Covering Standard: fixed cover <sup>1</sup>  
Insert Boxspring  
Foot Black runner  
Foot height 8, 16 cm

**Headboard:** Wood construction  
Width 160, 180, 200 cm (mattress dimensions)  
Height 120 cm  
Upholstery Polyfoam sandwich construction, fleece covered  
Covering Fixed cover  
Reverse Drill  
Headboard-mounting Floorstanding or flush with base

<sup>1</sup> Standard variant. Variants available for surcharge.

<sup>2</sup> Standard version: Spring base: Width 160 continuous or split; from 180 split

Falten sind design- verarbeitungs-, material-, bzw. benützungsbedingt und stellen keinen Reklamationsgrund dar.  
Wrinkles may occur due to design, treatment, quality of material and conditions of use and are no cause for claims.

# HEATHER *Design: Wittmann Workshop (2021)*

895XX

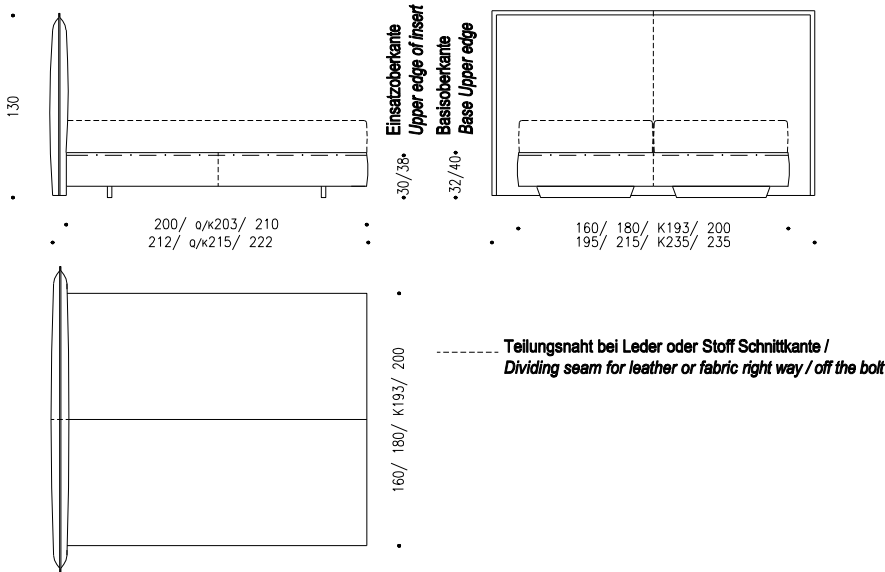

## Headboard

US King	W 92,52 x D 4,72 x H 51,18 in
US Queen	W 76,77 x D 4,72 x H 51,18 in

## Base

US King Inside Frame	L 79,92 x W 75,98 x H 11,81/14,96 in
US King Outer Frame	L 79,92 x W 75,98 x H 12,60/15,75 in
US Queen Inside Frame	L 79,92 x W 60,24 x H 11,81/14,96 in
US Queen Outer Frame	L 79,92 x W 60,24 x H 12,60/15,75 in

805

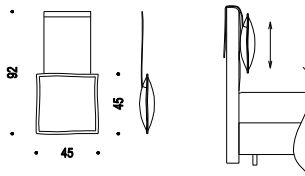

## Ausführungen:

<b>Kopfhauptkissen (KH):</b>	mit umlaufender Biese und Lappen mit Gegengewicht für stufenlose Höhenverstellung
Füllung	Federkissen
Bezug	Standard: Abnehmbar
Keder	Standard: Farbe wie Bezug
<b>Basis:</b>	Wittmann Spring (Holzkonstruktion)
Breite	160, 180, 200 cm, US Queen, US King (Matratzenmaß) <sup>2</sup>
Länge	200, 210 cm, US Queen, US King (Matratzenmaß)
Polsterung	Tonnentaschenfederkern, Polymousse, Vliesabdeckung
Bezug	Fixbezug <sup>1</sup>
Einsatz	Boxspring
Fuß	Kufe schwarz
Fußhöhe	8, 16 cm
<b>Kopfhaupt:</b>	Holzkonstruktion
Breite	160, 180, 200 cm (Matratzenmaß)
Höhe	130 cm
Polsterung	Polymousse-Sandwichaufbau, Vliesabdeckung
Bezug	Fixbezug <sup>1</sup>
Rückseite	Wie Bezug
Kopfhauptmontage	Bodenstehend oder bündig mit Basis

## Configurations:

<b>Headboard pillow (HB):</b>	With cording all around and flap with counterweight for continuous height adjustment
Füllung	Feather pillow
Cover	Standard: Removable
Piping	Standard: Color same as cover
<b>Bed base:</b>	Wittmann Spring (wood construction)
Width	160, 180, 200 cm, US Queen, US King (mattress dimensions) <sup>2</sup>
Length	200, 210 cm, US Queen, US King (mattress dimensions)
Upholstery	Pocket spring, polyfoam, fleece covered
Covering	Standard: fixed cover <sup>1</sup>
Insert	Boxspring
Foot	Black runner
Foot height	8, 16 cm
<b>Headboard:</b>	Wood construction
Width	160, 180, 200 cm (mattress dimensions)
Height	130 cm
Upholstery	Polyfoam sandwich construction, fleece covered
Covering	Standard: fixed cover <sup>1</sup>
Reverse	Same as cover
Headboard-mounting	Floorstanding or flush with base

<sup>1</sup> Standardausführung. Varianten gegen Aufpreis erhältlich.

<sup>2</sup> Spring Basis: Breite 160 durchgehend oder geteilt; ab Breite 180 geteilt

<sup>1</sup> Standard variant. Variants available for surcharge.

<sup>2</sup> Standard version: Spring base: Width 160 continuous or split; from 180 split

Falten sind design- verarbeitungs-, material-, bzw. benützungsbedingt und stellen keinen Reklamationsgrund dar.  
 Wrinkles may occur due to design, treatment, quality of material and conditions of use and are no cause for claims.

# METIS SOFT *Design: Wittmann Workshop (2021)*

894XX

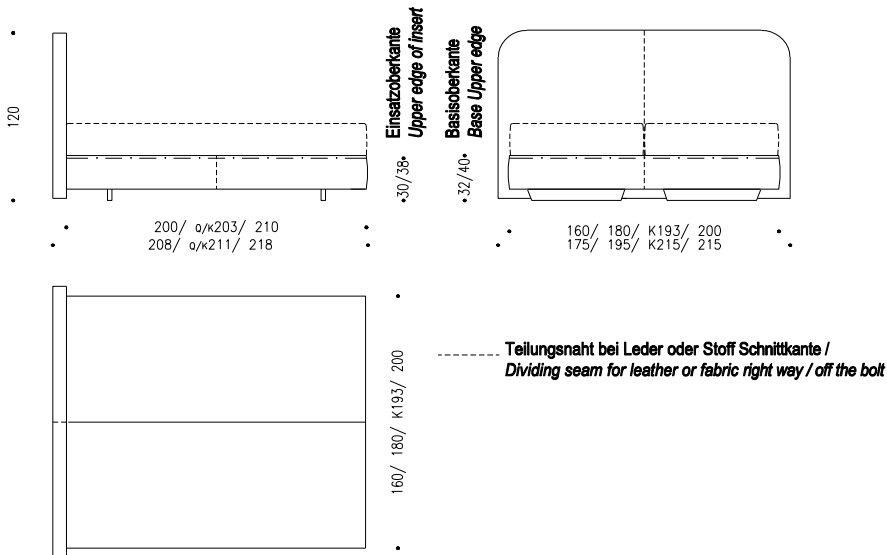

## Headboard

US King W 84,65 x D 3,15 x H 47,24 in  
US Queen W 68,90 x D 3,15 x H 47,24 in

## Base

US King Inside Frame L 79,92 x W 75,98 x H 11,81/14,96 in  
US King Outer Frame L 79,92 x W 75,98 x H 12,60/15,75 in

US Queen Inside Frame L 79,92 x W 60,24 x H 11,81/14,96 in  
US Queen Outer Frame L 79,92 x W 60,24 x H 12,60/15,75 in

805

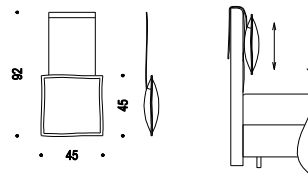

## Ausführungen:

<b>Kopfhauptkissen (KH):</b>	mit umlaufender Biese und Lappen mit Gegengewicht für stufenlose Höhenverstellung
Füllung	Federkissen
Bezug	Standard: Abnehmbar
Keder	Standard: Farbe wie Bezug
<b>Basis:</b>	Wittmann Spring (Holzkonstruktion)
Breite	160, 180, 200 cm, US Queen, US King (Matratzenmaß) <sup>3</sup>
Länge	200, 210 cm, US Queen, US King (Matratzenmaß)
Polsterung	Tonnentaschenfederkern, Polymousse, Vliesabdeckung
Bezug	Fixbezug <sup>1</sup>
Einsatz	Boxspring
Fuß	Kufe schwarz
Fußhöhe	8, 16 cm
<b>Kopfhauptmontage:</b>	Holzkonstruktion
Breite	160, 180, 200 cm (Matratzenmaß)
Höhe	120 cm
Polsterung	Polymousse-Sandwichaufbau, Vliesabdeckung
Bezug	Fixbezug
Rückseite	Drell
Kopfhauptmontage	Bodenstehend oder bündig mit Basis
Keder	Standard: wie Bezug oder Leder in den Standardfarben <sup>2</sup>

## Configurations:

<b>Headboard pillow (HB):</b>	With cording all around and flap with counterweight for continuous height adjustment
Filling	Feather pillow
Cover	Standard: Removable
Piping	Standard: Color same as cover
<b>Bed base:</b>	Wittmann Spring (wood construction)
Width	160, 180, 200 cm, US Queen, US King (mattress dimensions) <sup>3</sup>
Length	200, 210 cm, US Queen, US King (mattress dimensions)
Upholstery	Pocket spring, polyfoam, fleece covered
Covering	Standard: fixed cover <sup>1</sup>
Boxspring	Boxspring
Foot	Black runner
Foot height	8, 16 cm
<b>Headboard:</b>	Wood construction
Width	160, 180, 200 cm (mattress dimensions)
Height	120 cm
Upholstery	Polyfoam sandwich construction, fleece covered
Covering	Fixed cover
Reverse	Drill
Headboard-mounting	Floorstanding or flush with base
Piping	Standard: same as cover or leather in standard colour variants <sup>2</sup>

<sup>1</sup> Standardausführung. Varianten gegen Aufpreis erhältlich.

<sup>2</sup> Standardfarben Leder: Color atlantic, black, cognac, dark grey, mocca, sand, siena and taupe

<sup>3</sup> Spring Basis: Breite 160 durchgehend oder geteilt; ab Breite 180 geteilt

<sup>1</sup> Standard variant. Variants available for surcharge.

<sup>2</sup> Standard colours leather: Color atlantic, black, cognac, dark grey, mocca, sand, siena and taupe

<sup>3</sup> Standard version: Spring base: Width 160 continuous or split; from 180 split

Falten sind design- verarbeitungs-, material-, bzw. benützungsbedingt und stellen keinen Reklamationsgrund dar.  
Wrinkles may occur due to design, treatment, quality of material and conditions of use and are no cause for claims.

# STAN *Design: Wittmann Workshop (2021)*

896XX

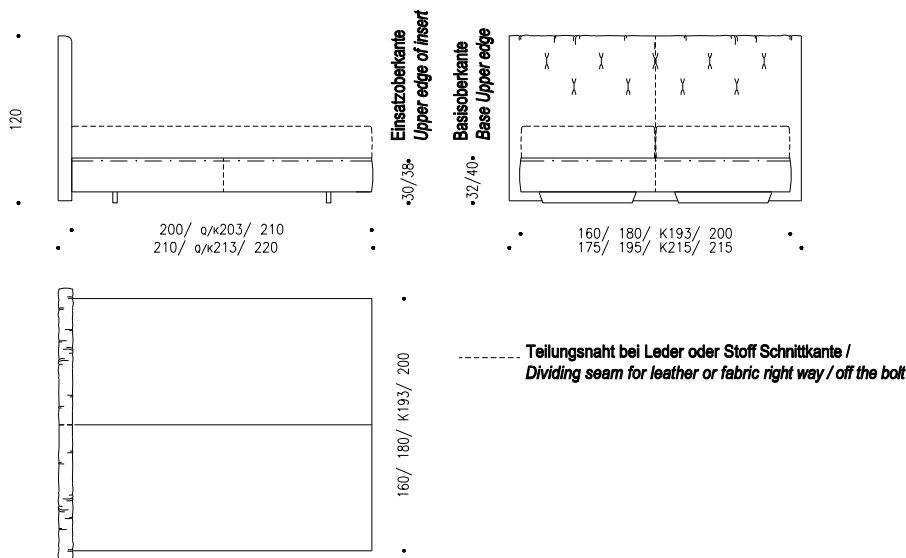

## Headboard

US King W 84,65 x D 3,94 x H 47,24 in  
US Queen W 68,90 x D 3,94 x H 47,24 in

## Base

US King Inside Frame L 79,92 x W 75,98 x H 11,81/14,96 in  
US King Outer Frame L 79,92 x W 75,98 x H 12,60/15,75 in

US Queen Inside Frame L 79,92 x W 60,24 x H 11,81/14,96 in  
US Queen Outer Frame L 79,92 x W 60,24 x H 12,60/15,75 in

805

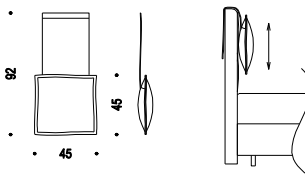

## Ausführungen:

<b>Kopfhauptkissen (KH):</b>	mit umlaufender Biese und Lappen mit Gegengewicht für stufenlose Höhenverstellung
Füllung	Federkissen
Bezug	Standard: Abnehmbar
Keder	Standard: Farbe wie Bezug
<b>Basis:</b>	Wittmann Spring (Holzkonstruktion)
Breite	160, 180, 200 cm, US Queen, US King (Matratzenmaß) <sup>2</sup>
Länge	200, 210 cm, US Queen, US King (Matratzenmaß)
Polsterung	Tonnentaschenfederkern, Polymousse, Vliesabdeckung
Bezug	Fixbezug <sup>1</sup>
Einsatz	Boxspring
Fuß	Kufe schwarz
Fußhöhe	8, 16 cm

<b>Kopfhaupt:</b>	Holzkonstruktion
Breite	160, 180, 200 cm (Matratzenmaß)
Höhe	120 cm
Polsterung	Polymousse-Sandwichaufbau, Vliesabdeckung
Bezug	Fixbezug
Rückseite	Drell
Kopfhauptmontage	Bodenstehend oder bündig mit Basis

<sup>1</sup> Standardausführung. Varianten gegen Aufpreis erhältlich.

<sup>2</sup> Spring Basis: Breite 160 durchgehend oder geteilt; ab Breite 180 geteilt

## Configurations:

<b>Headboard pillow (HB):</b>	With cording all around and flap with counterweight for continuous height adjustment
Füllung	Feather pillow
Cover	Standard: Removable
Piping	Standard: Color same as cover
<b>Bed base:</b>	Wittmann Spring (wood construction)
Width	160, 180, 200 cm, US Queen, US King (mattress dimensions) <sup>2</sup>
Length	200, 210 cm, US Queen, US King (mattress dimensions)
Upholstery	Pocket spring, polyfoam, fleece covered
Covering	Standard: fixed cover <sup>1</sup>
Insert	Boxspring
Foot	Black runner
Foot height	8, 16 cm
<b>Headboard:</b>	Wood construction
Width	160, 180, 200 cm (mattress dimensions)
Height	120 cm
Upholstery	Polyfoam sandwich construction, fleece covered
Covering	Standard: fixed cover
Reverse	Drill
Headboard-mounting	Floorstanding or flush with base

<sup>1</sup> Standard variant. Variants available for surcharge.

<sup>2</sup> Standard version: Spring base: Width 160 continuous or split; from 180 split

Falten sind design- verarbeitungs-, material-, bzw. benützungsbedingt und stellen keinen Reklamationsgrund dar.  
Wrinkles may occur due to design, treatment, quality of material and conditions of use and are no cause for claims.

# THEMIS *Design: Wittmann Workshop (2021)*

893XX

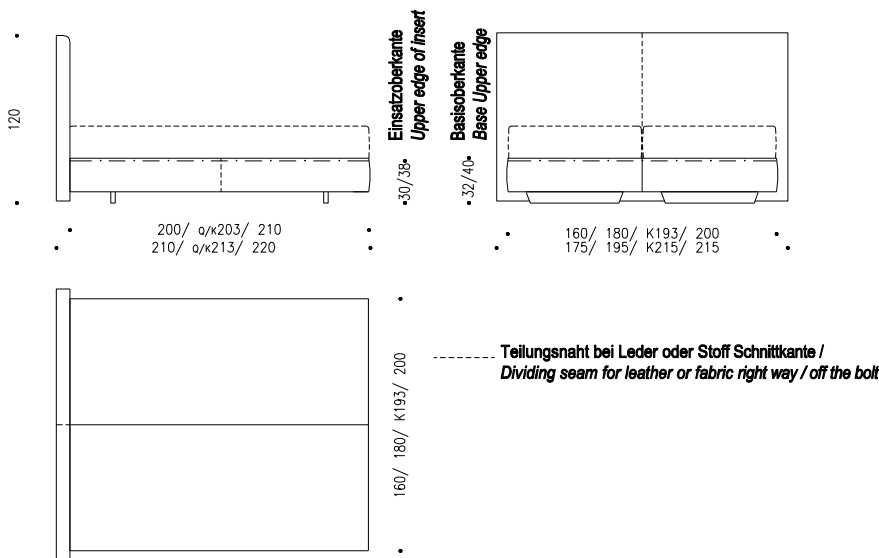

## Headboard

US King W 84,65 x D 3,94 x H 47,24 in  
US Queen W 68,90 x D 3,94 x H 47,24 in

## Base

US King Inside Frame L 79,92 x W 75,98 x H 11,81/14,96 in  
US King Outer Frame L 79,92 x W 75,98 x H 12,60/15,75 in

US Queen Inside Frame L 79,92 x W 60,24 x H 11,81/14,96 in  
US Queen Outer Frame L 79,92 x W 60,24 x H 12,60/15,75 in

805

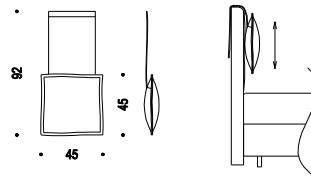

## Ausführungen:

<b>Kopfhauptkissen (KH):</b>	mit umlaufender Biese und Lappen mit Gegengewicht für stufenlose Höhenverstellung
Füllung	Federkissen
Bezug	Standard: Abnehmbar
Keder	Standard: Farbe wie Bezug
<b>Basis:</b>	Wittmann Spring (Holzkonstruktion)
Breite	160, 180, 200 cm, US Queen, US King (Matratzenmaß) <sup>2</sup>
Länge	200, 210 cm, US Queen, US King (Matratzenmaß)
Polsterung	Tonnentaschenfederkern, Polymousse, Vliesabdeckung
Bezug	Fixbezug <sup>1</sup>
Einsatz	Boxspring
Fuß	Kufe schwarz
Fußhöhe	8, 16 cm
<b>Kopfhaupt:</b>	Holzkonstruktion
Breite	160, 180, 200 cm (Matratzenmaß)
Höhe	120 cm
Polsterung	Polymousse-Sandwichaufbau, Vliesabdeckung
Bezug	Fixbezug <sup>1</sup>
Rückseite	Drell
Kopfhauptmontage	Bodenstehend oder bündig mit Basis

## Configurations:

<b>Headboard pillow (HB):</b>	With cording all around and flap with counterweight for continuous height adjustment
Füllung	Feather pillow
Cover	Standard: Removable
Piping	Standard: Color same as cover
<b>Bed base:</b>	Wittmann Spring (wood construction)
Width	160, 180, 200 cm, US Queen, US King (mattress dimensions) <sup>2</sup>
Length	200, 210 cm, US Queen, US King (mattress dimensions)
Upholstery	Pocket spring, polyfoam, fleece covered
Covering	Standard: fixed cover <sup>1</sup>
Insert	Boxspring
Foot	Black runner
Foot height	8, 16 cm
<b>Headboard:</b>	Wood construction
Width	160, 180, 200 cm (mattress dimensions)
Height	120 cm
Upholstery	Polyfoam sandwich construction, fleece covered
Covering	Standard: fixed cover <sup>1</sup>
Reverse	Drill
Headboard-mounting	Floorstanding or flush with base

<sup>1</sup> Standardausführung. Varianten gegen Aufpreis erhältlich.

<sup>2</sup> Spring Basis: Breite 160 durchgehend oder geteilt; ab Breite 180 geteilt

<sup>1</sup> Standard variant. Variants available for surcharge.

<sup>2</sup> Standard version: Spring base: Width 160 continuous or split; from 180 split

Falten sind design- verarbeitungs-, material-, bzw. benützungsbedingt und stellen keinen Reklamationsgrund dar.  
Wrinkles may occur due to design, treatment, quality of material and conditions of use and are no cause for claims.



# ADVANCED LINE

## Modulbetten / Modular beds

### Kopfhäupter / Headboards

S: Standard, A: Aufpreis / Surcharge, M: Minderpreis / Lowered price  
 D: Durchgehend / Continuous, G: Geteilt / Split

ALENA Kopfhaupt/Headboard  
 BRYAN Kopfhaupt/Headboard  
 CADEN Kopfhaupt/Headboard  
 HEATHER Kopfhaupt/Headboard  
 METIS SOFT Kopfhaupt/Headboard  
 QUEENS Kopfhaupt/Headboard  
 REGENT Kopfhaupt/Headboard  
 STAN Kopfhaupt/Headboard  
 THEMIS Kopfhaupt/Headboard  
 WITTMANN FRAME Bettbasis/Bed base  
 WITTMANN FRAME SLIM Bettbasis/Bed base  
 WITTMANN SPRING Bettbasis/Bed base  
 WITTMANN SPRING SLIM Bettbasis/Bed base

Ausführung / Configuration

Bezug / Covering	Kopfhaupt / Headboard										Basis / Base			
Kopfhaupt Rückseite bezogen (statt Drell) / Headboard reverse covered (instead of drill)	A	S <sup>1</sup>	A	S	A	A	A	A	A	A				
Kopfhaupt Bezug fix / Headboard fixed cover	S	S	S		S	S	S	S	S	S				
Kopfhaupt Bezug abnehmbar / Headboard removable cover					S						S			
Bettbasis Bezug fix / Bed base fixed cover														
Bettbasis Bezug abnehmbar / Bed base removable cover											S	S	S	S
<b>Fußhöhe / Foot height</b>														
Fußhöhe 8 cm / Foot height 8 cm											S	S	S	S
Fußhöhe 13 cm / Foot height 13 cm														
Fußhöhe 16 cm / Foot height 16 cm											S	S	S	
Fußhöhe 17 cm / Foot height 17 cm														
Fußhöhe 20 cm / Foot height 20 cm														
<b>Fuß / Foot</b>											S	S		
Rundrohrfuß 8 cm / Tubular foot 8 cm											A	A	A	A
Sichtfuß 8 cm / Visible foot 8 cm												A	A	A
Sichtfuß 16 cm / Visible foot 16 cm												S	S	S
Kufe (schwebend) 8 cm oder 16 cm / Runner (floating) 8 cm or 16 cm														
JOYCE Fuß 20 cm / JOYCE foot 20 cm														
ANDES Fuß 13 cm oder 17 cm / ANDES foot 13 cm or 17 cm														
Sockel 8 cm / Plinth base 8 cm														
<b>Ablage / Bedside tray</b>														
Links/rechts / Left/right														
Links/rechts / Left/right														
<b>Kopfhaupthöhe, -montage / Headboard height, mounting</b>														
Höhe 100 cm (HEATHER 110 cm) / Height 100 cm (HEATHER 110 cm)				S	S		S	S	S	S				
Höhe 120 cm (HEATHER 130 cm) / Height 120 cm (HEATHER 130 cm)		S	S	S	S	S	S	S	S	S				
Basis Unterkante bündig / Lower edge flush with base		S	S	S	S	S	S	S	S	S	S	S	S	S
Bodenstehend / Floorstanding		S	S	S	S	S	S	S	S	S	S	S	S	S
<b>Kopfhauptbreite / Headboard width</b>														
Breite 40 cm (Schwenkteil links und rechts) / Width 40 cm (tilt element left and right)		S												
Breite 100 cm / Width 100 cm		S	S	S	S	S	S	S	S	S				
Breite 120 cm / Width 120 cm		S	S	S	S	S	S	S	S	S				
Breite 140 cm / Width 140 cm		S	S	S	S	S	S	S	S	S				
Breite 160 cm / Width 160 cm		S		S	S	S	S	S	S	S				
Breite 180 cm / Width 180 cm		S		S	S	S	S	S	S	S				
Breite 200 cm / Width 200 cm		S		S	S	S	S	S	S	S				
<b>Bettbasisbreite <sup>1</sup> / Bed base width <sup>1</sup> (Matratzenmaß / Mattress dimensions)</b>														
Breite 90 cm (Kopfhaupt 100 cm) / Width 90 cm (headboard 100 cm)											D	D	D	D
Breite 100 cm / Width 100 cm											D	D	D	D
Breite 120 cm / Width 120 cm											D	D	D	D
Breite 140 cm / Width 140 cm											D	D	D	D
US Queen Size 153x203 cm (Kopfhaupt 160 cm) / US Queen Size 153x203 cm (headboard 160 cm)											D	D	D	D
Breite 160 cm / Width 160 cm											D	D	D/G	D/G
Breite 180 cm / Width 180 cm											D	D	G	G
US King Size 193x203 cm (Kopfhaupt 200 cm) / US King Size 193x203 cm (headboard 200 cm)											D	D	G	G
Breite 200 cm / Width 200 cm											D	D	G	G
<b>Bettbasislänge <sup>3</sup> / Bed base length <sup>3</sup> (Matratzenmaß / Mattress dimensions)</b>														
Länge 200 cm / Length 200 cm											S	S	S	S
Länge 210 cm / Length 210 cm											S	S	S	S
<b>Einsatz, Unterfederung / Insert, substrate</b>														
Boxspring / Boxspring													S	S
Comfort (160 cm durchgehend und geteilt, ab 180 cm geteilt) / Comfort (160 cm continuous or split, from 180 cm split)											S	S		
Superior (160 cm durchgehend und geteilt, ab 180 cm geteilt) / Superior (160 cm continuous or split, from 180 cm split)											A	A		
Motoren-Einsatz (160 cm durchgehend und geteilt, ab 180 cm geteilt) / Motor insert (160 cm continuous or split, from 180 cm split)											A	A		
Einreihen-Lattenrost (ab 160 cm geteilt, nicht für US Queen Size) / Single-row-slatted frame (from 160 cm split, not for US Queen Size)											M	M		

<sup>1</sup> Kopfhauptbreite entspricht Bettbasisbreite mit Ausnahme Bettbasisbreite 90 cm, US Queen Size und US King Size Headboard width is equal to bed base width, except for 90 cm, US Queen Size and US King Size bed bases.  
<sup>2</sup> Nur Schwenkteile mit Rückseite bezogen / Only tiltable elements with reverse covered  
<sup>3</sup> Auch in US Queen und US King Länge verfügbar. / Also available in US Queen and US King length.

# ALENA *Design: Wittmann Workshop (2021)*

884XX

• • 10

• 115/ 135/ 155/ 175/ 195/ 215 •

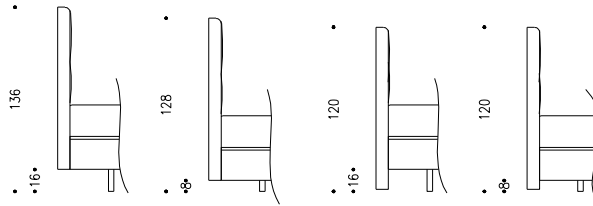
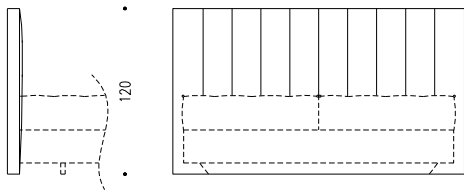

**Basis Unterkante bündig**  
*Lower edge of base flush*

**Bodenstehend**  
*Floorstanding*

## Headboard

US King W 84,65 x D 3,94 x H 47,24 in  
US Queen W 68,90 x D 3,94 x H 47,24 in

805

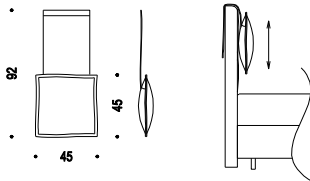

## Ausführungen:

<b>Kopfhaupt:</b>	Holzkonstruktion
Breite	100, 120, 140, 160, 180, 200 cm (Matratzenmaß)
Höhe	120 cm
Polsterung	Polymousse-Sandwichaufbau, Vliesabdeckung
Bezug	Fixbezug
Keder	Standard: wie Bezug oder Leder in den Standardfarben <sup>2</sup>
Rückseite	Drell <sup>1</sup>
Kopfhauptmontage	Bodenstehend oder bündig mit Basis

<sup>1</sup> Standardausführung. Varianten gegen Aufpreis erhältlich.

<sup>2</sup> Standardfarben Leder: Color atlantic, black, cognac, dark grey, mocca, sand, siena and taupe

## Configurations:

<b>Headboard:</b>	Wood construction
Width	100, 120, 140, 160, 180, 200 cm (mattress dimensions)
Height	120 cm
Upholstery	Polyfoam sandwich construction, fleece covered
Covering	Standard: fixed cover
Piping	Standard: same as cover or leather in standard colours <sup>2</sup>
Reverse	Drill <sup>1</sup>
Headboard-mounting	Floorstanding or flush with base

<sup>1</sup> Standard variant. Variants available for surcharge.

<sup>2</sup> Standard colours leather. Color atlantic, black, cognac, dark grey, mocca, sand, siena and taupe

Falten sind design- verarbeitungs-, material-, bzw. benützungsbedingt und stellen keinen Reklamationsgrund dar.  
*Wrinkles may occur due to design, treatment, quality of material and conditions of use and are no cause for claims.*

# BRYAN *Design: Wittmann Workshop (2021)*

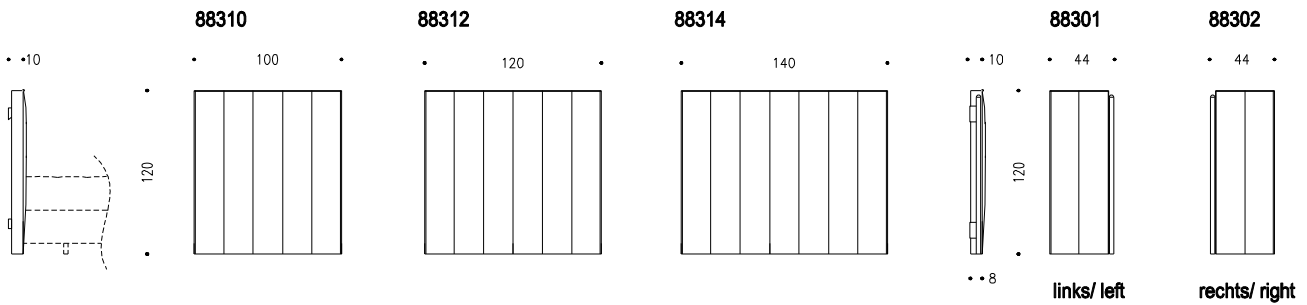

## Headboard

88310	W 39,37 x D 3,94 x H 47,24 in
88312	W 47,24 x D 3,94 x H 47,24 in
88314	W 55,12 x D 3,94 x H 47,24 in
88301	W 17,32 x D 3,94 x H 47,24 in
88302	W 17,32 x D 3,94 x H 47,24 in

## Kombinationsbeispiel Combination example

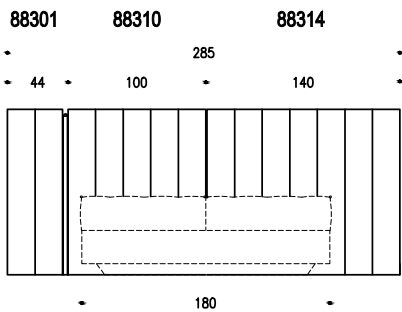

Bei asymmetrischer Zusammenstellung ist dem Auftrag unbedingt eine Skizze beizufügen.  
In the case of asymmetrical composition, a sketch must be attached to the order.

## Ausführungen:

<b>Kopfhaupt:</b>	Holzkonstruktion
Breite	40 (Schwenkteil links/rechts), 100, 120, 140 cm
Höhe	120 cm
Polsterung	Polymousse-Sandwichaufbau, Vliesabdeckung
Bezug	Fixbezug
Keder	Standard: wie Bezug oder Leder in den Standardfarben <sup>2</sup>
Rückseite	Schwenkteil wie Bezug, andere Elemente Drell
Kopfhauptmontage	<b>Bodenstehend, Wandmontage mit Keilleisten</b>

<sup>1</sup> Standardausführung. Varianten gegen Aufpreis erhältlich.

<sup>2</sup> Standardfarben Leder: Color atlantic, black, cognac, dark grey, mocca, sand, siena and taupe

## Configurations:

<b>Headboard:</b>	Wood construction
Width	40 (tiltable element left/right), 100, 120, 140 cm
Height	120 cm
Upholstery	Polyfoam sandwich construction, fleece covered
Covering	Standard: fixed cover
Piping	Standard: same as cover or leather in standard colours <sup>2</sup>
Reverse	Tiltable element same as colour, other elements drill
Headboard-mounting	<b>Floorstanding, wall mounted with wedge bars</b>

<sup>1</sup> Standard variant. Variants available for surcharge.

<sup>2</sup> Standard colours leather. Color atlantic, black, cognac, dark grey, mocca, sand, siena and taupe

Falten sind design- verarbeitungs-, material-, bzw. benützungsbedingt und stellen keinen Reklamationsgrund dar.  
Wrinkles may occur due to design, treatment, quality of material and conditions of use and are no cause for claims.

# CADEN *Design: Wittmann Workshop (2021)*

889XX

• • 10

• 115/ 135/ 155/ 175/ 195/ 215 •

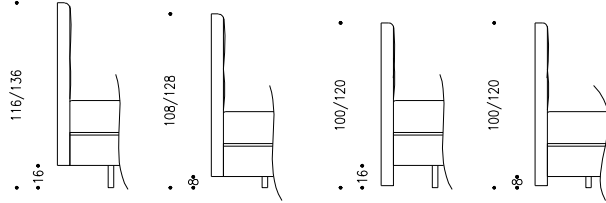
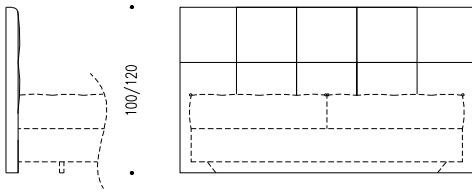

## Headboard

US King W 84,65 x D 3,94 x H 39,37/47,24 in  
US Queen W 68,90 x D 3,94 x H 39,37/47,24 in

805

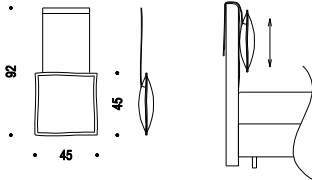

## Ausführungen:

<b>Kopfhaupt:</b>	Holzkonstruktion
Breite	100, 120, 140, 160, 180, 200 cm (Matratzenmaß)
Höhe	100, 120 cm
Polsterung	Polymousse-Sandwichaufbau, Vliesabdeckung
Bezug	Fixbezug
Rückseite	Drell <sup>1</sup>
Kopfhauptmontage	Bodenstehend oder bündig mit Basis

<sup>1</sup> Standardausführung. Varianten gegen Aufpreis erhältlich.

## Configurations:

<b>Headboard:</b>	Wood construction
Width	100, 120, 140, 160, 180, 200 cm (mattress dimensions)
Height	100, 120 cm
Upholstery	Polyfoam sandwich construction, fleece covered
Covering	Standard: fixed cover
Reverse	Drill <sup>1</sup>
Headboard-mounting	Floorstanding or flush with base

<sup>1</sup> Standard variant. Variants available for surcharge.

Falten sind design- verarbeitungs-, material-, bzw. benützungsbedingt und stellen keinen Reklamationsgrund dar.  
Wrinkles may occur due to design, treatment, quality of material and conditions of use and are no cause for claims.

# HEATHER *Design: Wittmann Workshop (2021)*

887XX

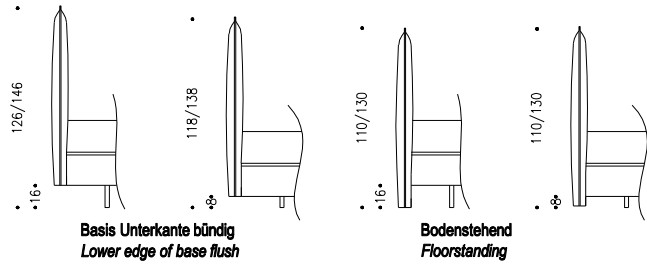
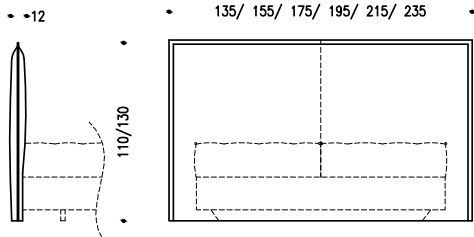

----- Teilungsnaht bei Leder oder Stoff Schnittkante /  
Dividing seam for leather or fabric right way/off the bolt

805

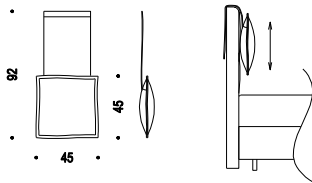

## Ausführungen:

<b>Kopfhaupt:</b>	Holzkonstruktion
Breite	100, 120, 140, 160, 180, 200 cm (Matratzenmaß)
Höhe	110, 130 cm
Polsterung	Polymousse-Sandwichaufbau, Vliesabdeckung
Bezug	Abnehmbar
Rückseite	Wie Bezug
Kopfhauptmontage	Bodenstehend oder bündig mit Basis

## Configurations:

<b>Headboard:</b>	Wood construction
Width	100, 120, 140, 160, 180, 200 cm (mattress dimensions)
Height	110, 130 cm
Upholstery	Polyfoam sandwich construction, fleece covered
Covering	Removable
Reverse	Same as cover
Headboard-mounting	Floorstanding or flush with base

Falten sind design- verarbeitungs-, material-, bzw. benützungsbedingt und stellen keinen Reklamationsgrund dar.  
*Wrinkles may occur due to design, treatment, quality of material and conditions of use and are no cause for claims.*

# METIS SOFT *Design: Wittmann Workshop (2018)*

886XX

• • 8

• 115/ 135/ 155/ 175/ 195/ 215 •

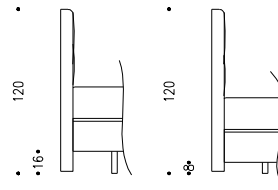
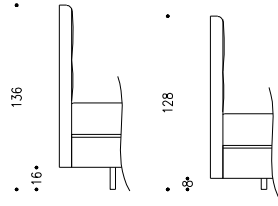
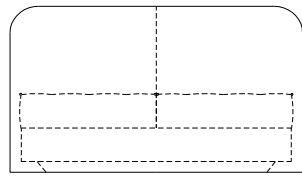
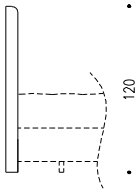

**Basis Unterkante bündig**  
*Lower edge of base flush*

**Bodenstehend**  
*Floorstanding*

## Headboard

US King W 84,65 x D 3,15 x H 47,24 in  
US Queen W 68,90 x D 3,15 x H 47,24 in

----- Teilungsnaht bei Leder oder Stoff Schnittkante /  
*Dividing seam for leather or fabric right way/off the bolt*

805

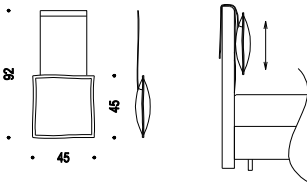

## Ausführungen:

<b>Kopfhaupt:</b>	Holzkonstruktion
Breite	100, 120, 140, 160, 180, 200 cm (Matratzenmaß)
Höhe	120 cm
Polsterung	Polymousse-Sandwichaufbau, Vliesabdeckung
Bezug	Fixbezug
Rückseite	Drell <sup>1</sup>
Keder	Standard: wie Bezug oder Leder in den Standardfarben <sup>2</sup>
Kopfhauptmontage	Bodenstehend oder bündig mit Basis

<sup>1</sup> Standardausführung. Varianten gegen Aufpreis erhältlich.

<sup>2</sup> Standardfarben Leder: Color atlantic, black, cognac, dark grey, mocca, sand, siena and taupe

## Configurations:

<b>Headboard:</b>	Wood construction
Width	100, 120, 140, 160, 180, 200 cm (mattress dimensions)
Height	120 cm
Upholstery	Polyfoam sandwich construction, fleece covered
Covering	Standard: fixed cover
Reverse	Drill <sup>1</sup>
Piping	standard: same as cover or leather in standard colours <sup>2</sup>
Headboard-mounting	Floorstanding or flush with base

<sup>1</sup> Standard variant. Variants available for surcharge.

<sup>2</sup> Standard colours leather. Color atlantic, black, cognac, dark grey, mocca, sand, siena and taupe

Falten sind design- verarbeitungs-, material-, bzw. benützungsbedingt und stellen keinen Reklamationsgrund dar.  
*Wrinkles may occur due to design, treatment, quality of material and conditions of use and are no cause for claims.*

# QUEENS *Design: Wittmann Workshop (2021)*

881XX

• •10

• 115/ 135/ 155/ 175/ 195/ 215 •

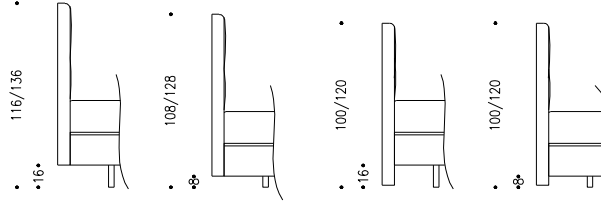
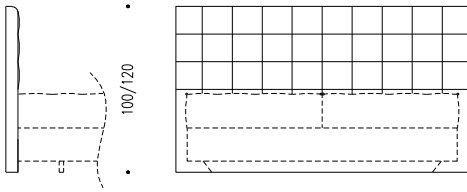

**Basis Unterkante bündig**  
*Lower edge of base flush*

**Bodenstehend**  
*Floorstanding*

## Headboard

US King W 84,65 x D 3,94 x H 39,37/47,24 in

US Queen W 68,90 x D 3,94 x H 39,37/47,24 in

805

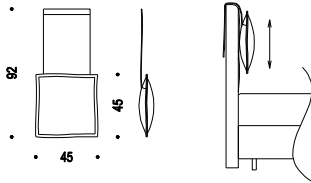

## Ausführungen:

<b>Kopfhaupt:</b>	Holzkonstruktion
Breite	100, 120, 140, 160, 180, 200 cm (Matratzenmaß)
Höhe	100, 120 cm
Polsterung	Polymousse-Sandwichaufbau, Vliesabdeckung
Bezug	Fixbezug
Rückseite	Drell <sup>1</sup>
Kopfhauptmontage	Bodenstehend oder bündig mit Basis

<sup>1</sup> Standardausführung. Varianten gegen Aufpreis erhältlich.

## Configurations:

<b>Headboard:</b>	Wood construction
Width	100, 120, 140, 160, 180, 200 cm (mattress dimensions)
Height	100, 120 cm
Upholstery	Polyfoam sandwich construction, fleece covered
Covering	Standard: fixed cover
Reverse	Drill <sup>1</sup>
Headboard-mounting	Floorstanding or flush with base

<sup>1</sup> Standard variant. Variants available for surcharge.

Falten sind design- verarbeitungs-, material-, bzw. benützungsbedingt und stellen keinen Reklamationsgrund dar.  
*Wrinkles may occur due to design, treatment, quality of material and conditions of use and are no cause for claims.*

# REGENT *Design: Wittmann Workshop (2021)*

882XX

• •10

• 115/ 135/ 155/ 175/ 195/ 215 •

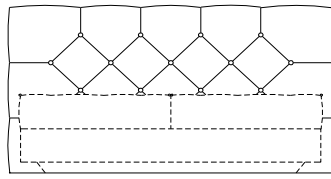
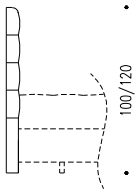

• 116/136 •

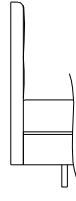

• 108/128 •



• 100/120 •

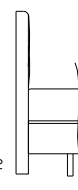

• 100/120 •



**Basis Unterkante bündig**  
**Lower edge of base flush**

**Bodenstehend**  
**Floorstanding**

## Headboard

US King W 84,65 x D 3,94 x H 39,37/47,24 in  
US Queen W 68,90 x D 3,94 x H 39,37/47,24 in

805

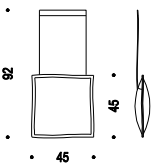

## Ausführungen:

<b>Kopfhaupt:</b>	Holzkonstruktion
Breite	100, 120, 140, 160, 180, 200 cm (Matratzenmaß)
Höhe	100, 120 cm
Polsterung	Polymousse-Sandwichaufbau, Vliesabdeckung
Bezug	Fixbezug
Rückseite	Drell <sup>1</sup>
Keder / Knopf	Standard: wie Bezug oder Leder in den Standardfarben <sup>2</sup>
Kopfhauptmontage	Bodenstehend oder bündig mit Basis

<sup>1</sup> Standardausführung. Varianten gegen Aufpreis erhältlich.

<sup>2</sup> Standardfarben Leder: Color atlantic, black, cognac, dark grey, mocca, sand, siena and taupe

## Configurations:

<b>Headboard:</b>	Wood construction
Width	100, 120, 140, 160, 180, 200 cm (mattress dimensions)
Height	100, 120 cm
Upholstery	Polyfoam sandwich construction, fleece covered
Covering	Standard: fixed cover
Reverse	Drill <sup>1</sup>
Piping / Button	Standard: same as cover or leather in standard colours <sup>2</sup>
Headboard-mounting	Floorstanding or flush with base

<sup>1</sup> Standard variant. Variants available for surcharge.

<sup>2</sup> Standard colours leather. Color atlantic, black, cognac, dark grey, mocca, sand, siena and taupe

Falten sind design- verarbeitungs-, material-, bzw. benützungsbedingt und stellen keinen Reklamationsgrund dar.  
**Wrinkles may occur due to design, treatment, quality of material and conditions of use and are no cause for claims.**



# STAN *Design: Wittmann Workshop (2021)*

888XX

• • 10

• 115/ 135/ 155/ 175/ 195/ 215 •

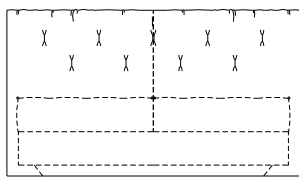
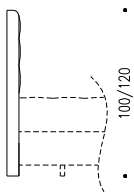

• 116/136 •

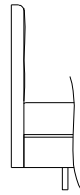

• 108/128 •

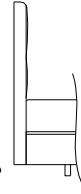

• 100/120 •

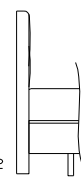

• 100/120 •



**Basis Unterkante bündig**  
*Lower edge of base flush*

**Bodenstehend**  
*Floorstanding*

**Headboard**

US King W 84,65 x D 3,94 x H 39,37/47,24 in  
US Queen W 68,90 x D 3,94 x H 39,37/47,24 in

----- Teilungsnaht bei Leder oder Stoff Schnittkante /  
*Dividing seam for leather or fabric right way/off the bolt*

805

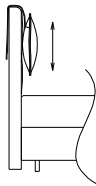
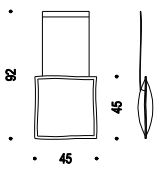

**Ausführungen:**

**Kopfhaupt:** Holzkonstruktion  
Breite 100, 120, 140, 160, 180, 200 cm (Matratzenmaß)  
Höhe 100, 120 cm  
Polsterung Polymousse-Sandwichaufbau, Vliesabdeckung  
Bezug Fixbezug  
Rückseite Drell<sup>1</sup>  
Kopfhauptmontage Bodenstehend oder bündig mit Basis

<sup>1</sup> Standardausführung. Varianten gegen Aufpreis erhältlich.

**Configurations:**

**Headboard:** Wood construction  
Width 100, 120, 140, 160, 180, 200 cm (mattress dimensions)  
Height 100, 120 cm  
Upholstery Polyfoam sandwich construction, fleece covered  
Covering Standard: fixed cover  
Reverse Drill<sup>1</sup>  
Headboard-mounting Floorstanding or flush with base

<sup>1</sup> Standard variant. Variants available for surcharge.

Falten sind design- verarbeitungs-, material-, bzw. benützungsbedingt und stellen keinen Reklamationsgrund dar.  
*Wrinkles may occur due to design, treatment, quality of material and conditions of use and are no cause for claims.*

# THEMIS *Design: Wittmann Workshop (2021)*

885XX

• 10 • 115/ 135/ 155/ 175/ 195/ 215 •

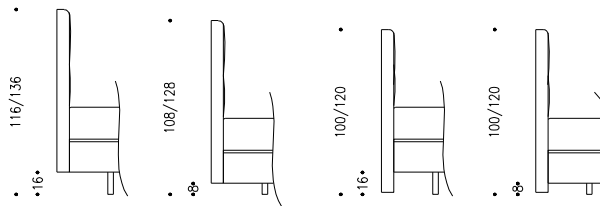
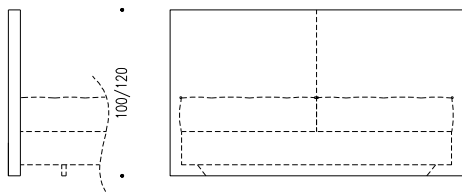

**Basis Unterkante bündig**  
*Lower edge of base flush*

**Bodenstehend**  
*Floorstanding*

## Headboard

US King W 84,65 x D 3,94 x H 39,37/47,24 in

US Queen W 68,90 x D 3,94 x H 39,37/47,24 in

----- Teilungsnaht bei Leder oder Stoff Schnittkante /  
*Dividing seam for leather or fabric right way/off the bolt*

805

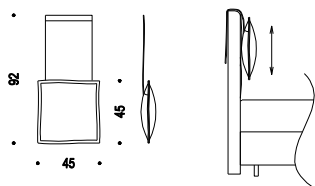

## Ausführungen:

<b>Kopfhaupt:</b>	Holzkonstruktion
Breite	100, 120, 140, 160, 180, 200 cm (Matratzenmaß)
Höhe	100, 120 cm
Polsterung	Polymousse-Sandwichaufbau, Vliesabdeckung
Bezug	Abnehmbar
Rückseite	Drell <sup>1</sup>
Kopfhaupt- montage	Bodenstehend oder bündig mit Basis

<sup>1</sup> Standardausführung. Varianten gegen Aufpreis erhältlich.

## Configurations:

<b>Headboard:</b>	Wood construction
Width	100, 120, 140, 160, 180, 200 cm (mattress dimensions)
Height	100, 120 cm
Upholstery	Polyfoam sandwich construction, fleece covered
Covering	Removable
Reverse	Drill <sup>1</sup>
Headboard- mounting	Floorstanding or flush with base

<sup>1</sup> Standard variant. Variants available for surcharge.

Falten sind design- verarbeitungs-, material-, bzw. benützungsbedingt und stellen keinen Reklamationsgrund dar.  
*Wrinkles may occur due to design, treatment, quality of material and conditions of use and are no cause for claims.*

# ADVANCED LINE

## Modulbetten / Modular beds

### Bettbasen / Bed bases

Ausführung / Configuration

**S:** Standard, **A:** Aufpreis / Surcharge, **M:** Minderpreis / Lower price  
**D:** Durchgehend / Continuous, **G:** Geteilt / Split

ALENA Kopfhaupt/Headboard  
 BRYAN Kopfhaupt/Headboard  
 CADEN Kopfhaupt/Headboard  
 HEATHER Kopfhaupt/Headboard  
 METIS SOFT Kopfhaupt/Headboard  
 QUEENS Kopfhaupt/Headboard  
 REGENT Kopfhaupt/Headboard  
 STAN Kopfhaupt/Headboard  
 THEMIS Kopfhaupt/Headboard  
 WITTMANN FRAME Bettbasis/Bed base  
 WITTMANN FRAME SLIM Bettbasis/Bed base  
 WITTMANN SPRING Bettbasis/Bed base  
 WITTMANN SPRING SLIM Bettbasis/Bed base

Bezug / Covering	Kopfhaupt / Headboard										Basis / Base				
Kopfhaupt Rückseite bezogen (statt Drell) / Headboard reverse covered (instead of drill)	A	S <sup>2</sup>	A	S	A	A	A	A	A	A					
Kopfhaupt Bezug fix / Headboard fixed cover	S	S	S		S	S	S	S	S						
Kopfhaupt Bezug abnehmbar / Headboard removable cover				S							S				
Bettbasis Bezug fix / Bed base fixed cover															
Bettbasis Bezug abnehmbar / Bed base removable cover											S	S	S	S	
<b>Fußhöhe / Foot height</b>															
Fußhöhe 8 cm / Foot height 8 cm												S	S	S	S
Fußhöhe 13 cm / Foot height 13 cm															
Fußhöhe 16 cm / Foot height 16 cm												S	S	S	
Fußhöhe 17 cm / Foot height 17 cm															
Fußhöhe 20 cm / Foot height 20 cm															
<b>Fuß / Foot</b>															
Rundrohrfuß 8 cm / Tubular foot 8 cm												S	S		
Sichtfuß 8 cm / Visible foot 8 cm												A	A	A	A
Sichtfuß 16 cm / Visible foot 16 cm													A	A	A
Kufe (schwebend) 8 cm oder 16 cm / Runner (floating) 8 cm or 16 cm													S	S	S
JOYCE Fuß 20 cm / JOYCE foot 20 cm															
ANDES Fuß 13 cm oder 17 cm / ANDES foot 13 cm or 17 cm															
Sockel 8 cm / Plinth base 8 cm															
<b>Ablage / Bedside tray</b>															
Links/rechts / Left/right															
Links/rechts / Left/right															
<b>Kopfhaupthöhe, -montage / Headboard height, mounting</b>															
Höhe 100 cm (HEATHER 110 cm) / Height 100 cm (HEATHER 110 cm)			S	S		S	S	S	S	S					
Höhe 120 cm (HEATHER 130 cm) / Height 120 cm (HEATHER 130 cm)	S	S	S	S	S	S	S	S	S	S					
Basis Unterkante bündig / Lower edge flush with base	S		S	S	S	S	S	S	S	S	S	S	S	S	
Bodenstehend / Floorstanding	S	S	S	S	S	S	S	S	S	S	S	S	S	S	S
<b>Kopfhauptbreite / Headboard width</b>															
Breite 40 cm (Schwenkteil links und rechts) / Width 40 cm (tilt element left and right)		S													
Breite 100 cm / Width 100 cm	S	S	S	S	S	S	S	S	S	S					
Breite 120 cm / Width 120 cm	S	S	S	S	S	S	S	S	S	S					
Breite 140 cm / Width 140 cm	S	S	S	S	S	S	S	S	S	S					
Breite 160 cm / Width 160 cm	S		S	S	S	S	S	S	S	S					
Breite 180 cm / Width 180 cm	S		S	S	S	S	S	S	S	S					
Breite 200 cm / Width 200 cm	S		S	S	S	S	S	S	S	S					
<b>Bettbasisbreite<sup>1</sup> / Bed base width<sup>1</sup> (Matratzenmaß / Mattress dimensions)</b>															
Breite 90 cm (Kopfhaupt 100 cm) / Width 90 cm (headboard 100 cm)												D	D	D	D
Breite 100 cm / Width 100 cm												D	D	D	D
Breite 120 cm / Width 120 cm												D	D	D	D
Breite 140 cm / Width 140 cm												D	D	D	D
US Queen Size 153x203 cm (Kopfhaupt 160 cm) / US Queen Size 153x203 cm (headboard 160 cm)												D	D	D	D
Breite 160 cm / Width 160 cm												D	D	D/G	D/G
Breite 180 cm / Width 180 cm												D	D	G	G
US King Size 193x203 cm (Kopfhaupt 200 cm) / US King Size 193x203 cm (headboard 200 cm)												D	D	G	G
Breite 200 cm / Width 200 cm												D	D	G	G
<b>Bettbasislänge<sup>3</sup> / Bed base length<sup>3</sup> (Matratzenmaß / Mattress dimensions)</b>															
Länge 200 cm / Length 200 cm												S	S	S	S
Länge 210 cm / Length 210 cm												S	S	S	S
<b>Einsatz, Unterfederung / Insert, substrate</b>															
Boxspring / Boxspring														S	S
Comfort (160 cm durchgehend und geteilt, ab 180 cm geteilt) Comfort (160 cm continuous or split, from 180 cm split)													S	S	
Superior (160 cm durchgehend und geteilt, ab 180 cm geteilt) Superior (160 cm continuous or split, from 180 cm split)												A	A		
Motoren-Einsatz (160 cm durchgehend und geteilt, ab 180 cm geteilt) Motor insert (160 cm continuous or split, from 180 cm split)												A	A		
Einreihen-Lattenrost (ab 160 cm geteilt, nicht für US Queen Size) Single-row-slatted frame (from 160 cm split, not for US Queen Size)												M	M		

<sup>1</sup> Kopfhauptbreite entspricht Bettbasisbreite mit Ausnahme Bettbasisbreite 90 cm, US Queen Size und US King Size  
 Headboard width is equal to bed base width, except for 90 cm, US Queen Size and US King Size bed bases.

<sup>2</sup> Nur Schwenkteile mit Rückseite bezogen / Only tiltable elements with reverse covered

<sup>3</sup> Auch in US Queen und US King Länge verfügbar. / Also available in US Queen and US King length.

**Fremdeinsätze: Kombination mit Fremdeinsätzen- und Matratzen nur auf Anfrage**  
 Combination with third party inserts possible and mattresses only on request  
 Die Liegehöhe ergibt sich aus der Einsatzoberkante zzgl. Matratzenhöhe.  
 Sleeping height is equal to the upper edge of insert plus the height of the mattress.

# WITTMANN FRAME *Design: Wittmann Workshop (2021)*

Rahmenbreite 4 cm / *Frame width 4 cm*

874XX

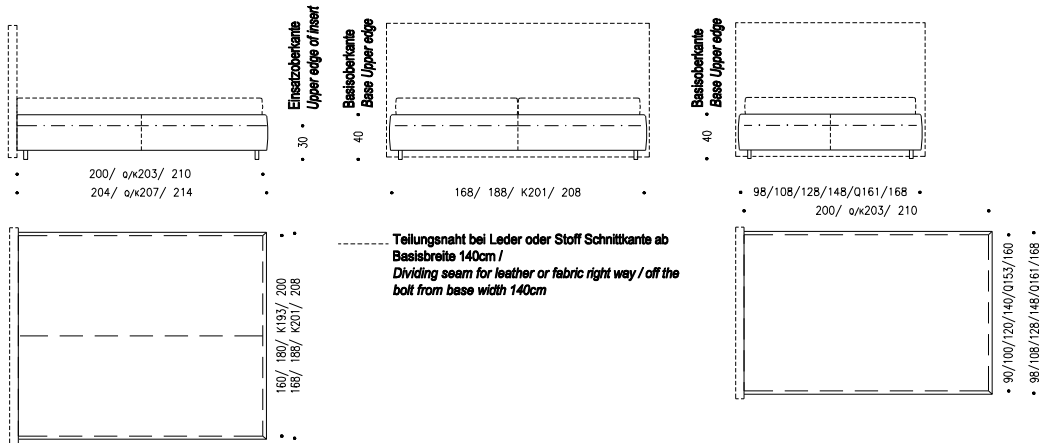

## US King

**Inside Frame** L 79,92 x W 75,98 x H 11,81 in  
**Outer Frame** L 81,50 x W 79,13 x H 15,75 in

## US Queen

**Inside Frame** L 79,92 x W 60,24 x H 11,81 in  
**Outer Frame** L 81,50 x W 63,39 x H 15,75 in

**Einsatzgröße = Matratzenbreite /** *Mattress width - 1,5 cm*  
**Insert size** *Matratzenlänge / Mattresses length - 3 cm*

**Einsatz in der Höhe verstellbar**  
*Adjustable height insert*

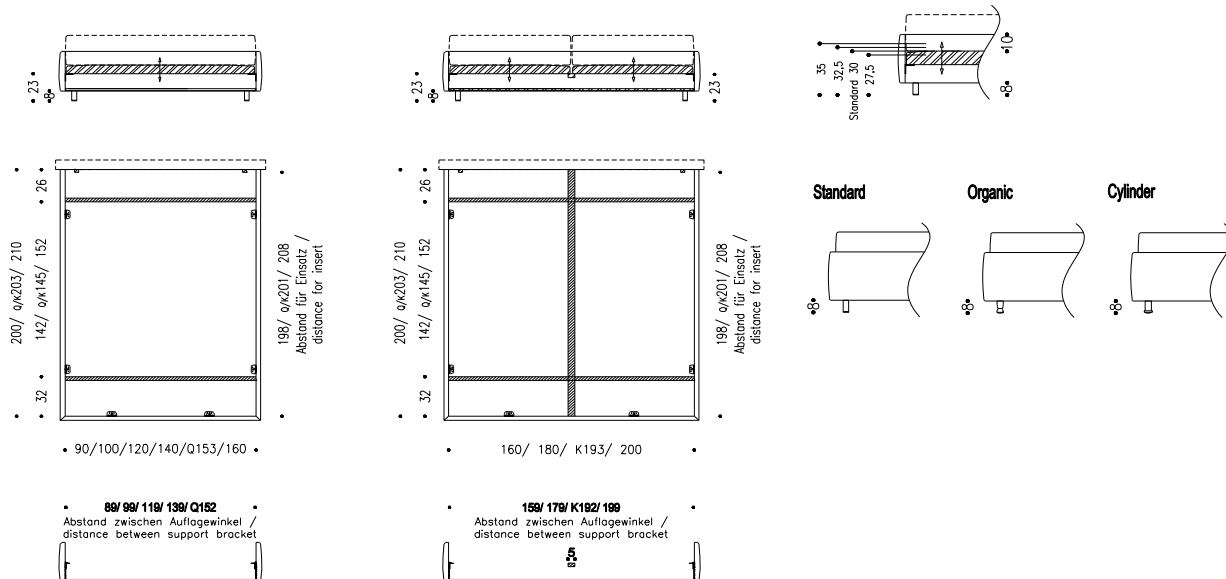

## Ausführungen:

<b>Basis:</b>	Metall-Holzkonstruktion, schwarz pulverbeschichtet
<b>Breite</b>	90, 100, 120, 140, 160, 180, 200 cm, US Queen, US King (Matratzenmaß)
<b>Länge</b>	200, 210 cm, US Queen, US King (Matratzenmaß)
<b>Polsterung</b>	Polymousse, Vliesabdeckung
<b>Bezug</b>	Abnehmbar
<b>Einsatz</b>	Standard: Comfort <sup>1 2</sup>
<b>Fuß</b>	Standard: Rundrohrfuß schwarz pulverbeschichtet <sup>1</sup>
<b>Fußhöhe</b>	8 cm

<sup>1</sup> Standardausführung. Varianten gegen Aufpreis erhältlich.

<sup>2</sup> Breite 160 cm Einsatz durchgehend oder geteilt; ab Breite 180 cm Einsatz geteilt

## Configurations:

<b>Bed base:</b>	<i>Metal and wood construction, powder-coated black</i>
<b>Width</b>	<i>90, 100, 120, 140, 160, 180, 200 cm, US Queen, US King (mattress dimensions)</i>
<b>Length</b>	<i>200, 210 cm, US Queen, US King (mattress dimensions)</i>
<b>Upholstery</b>	<i>Polyfoam, fleece covered</i>
<b>Covering</b>	<i>Removable</i>
<b>Insert</b>	<i>Standard: Comfort <sup>1 2</sup></i>
<b>Foot</b>	<i>Standard: Tubular foot powder-coated black <sup>1</sup></i>
<b>Foot height</b>	<i>8 cm</i>

<sup>1</sup> Standard variant. Variants available for surcharge.

<sup>2</sup> Width 160 cm insert continuous or split; from 180 cm insert split

Falten sind design- verarbeitungs-, material-, bzw. benützungsbedingt und stellen keinen Reklamationsgrund dar.  
*Wrinkles may occur due to design, treatment, quality of material and conditions of use and are no cause for claims.*

# WITTMANN FRAME SLIM Design: Wittmann Workshop (2021)

Rahmenbreite 4 cm / Frame width 4 cm

875XX

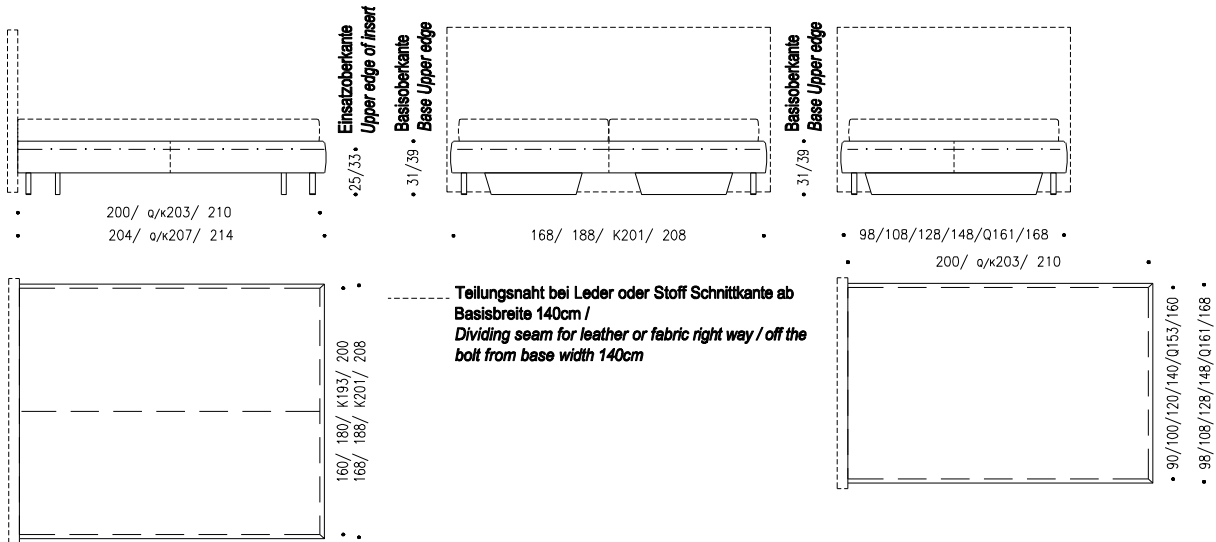

**US King**  
 Inside Frame L 79,92 x W 75,98 x H 9,84/12,99 in  
 Outer Frame L 81,50 x W 79,13 x H 12,20/15,35 in

**US Queen**  
 Inside Frame L 79,92 x W 60,24 x H 9,84/12,99 in  
 Outer Frame L 81,50 x W 63,39 x H 12,20/15,35 in

Einsatzgröße = Matratzenbreite / Mattress width - 1,5 cm  
 Insert size Matratzenlänge / Mattresses length - 3 cm

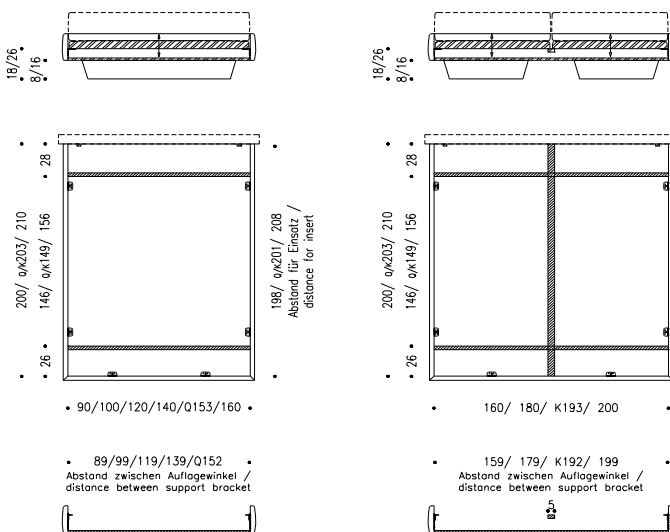

**Einsatz in der Höhe verstellbar 8cm**  
 Adjustable height insert 8cm

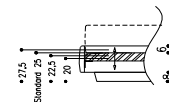

**Einsatz in der Höhe verstellbar 16cm**  
 Adjustable height insert 16cm

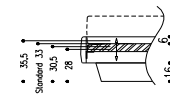

**Standard / Standard**

**Kufe / Runner 8cm**

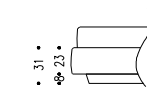

**Kufe / Runner 16cm**

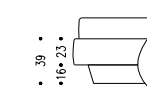

**Varianten / Variants**

**Rundrohrfuß / Tubular foot 8cm**

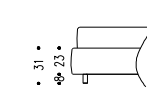

**Rundrohrfuß / Tubular foot 16cm**

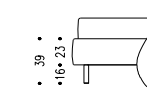

**Cylinder 8cm**

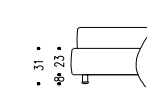

**Cylinder 16cm**

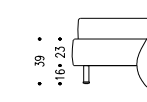

**Organic 8cm**

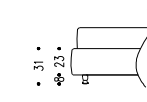

**Organic 16cm**

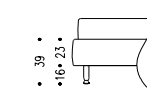

## Ausführungen:

**Basis:** Metall-Holzkonstruktion, schwarz pulverbeschichtet  
**Breite:** 90, 100, 120, 140, 160, 180, 200 cm, US Queen, US King (Matratzenmaß)  
**Länge:** 200, 210 cm, US Queen, US King (Matratzenmaß)  
**Polsterung:** Polymousse, Vliesabdeckung  
**Bezug:** Abnehmbar  
**Einsatz:** Standard: Comfort <sup>1 2</sup>  
**Fuß:** Standard: Kufe schwarz <sup>1</sup>  
**Fußhöhe:** 8, 16 cm

<sup>1</sup> Standardausführung. Varianten gegen Aufpreis erhältlich.

<sup>2</sup> Breite 160 cm Einsatz durchgehend oder geteilt; ab Breite 180 cm Einsatz geteilt

## Configurations:

**Bed base:** Metal and wood construction, powder-coated black  
**Width:** 90, 100, 120, 140, 160, 180, 200 cm, US Queen, US King (mattress dimensions)  
**Length:** 200, 210 cm, US Queen, US King (mattress dimensions)  
**Upholstery:** Polyfoam, fleece covered  
**Covering:** Removable  
**Insert:** Standard: Comfort <sup>1 2</sup>  
**Foot:** Standard: Black runner <sup>1</sup>  
**Foot height:** 8, 16 cm

<sup>1</sup> Standard variant. Variants available for surcharge.

<sup>2</sup> Width 160 cm insert continuous or split; from 180 cm insert split

Falten sind design- verarbeitungs-, material-, bzw. benützungsbedingt und stellen keinen Reklamationsgrund dar.  
 Wrinkles may occur due to design, treatment, quality of material and conditions of use and are no cause for claims.

# WITTMANN SPRING *Design: Wittmann Workshop (2021)*

872XX

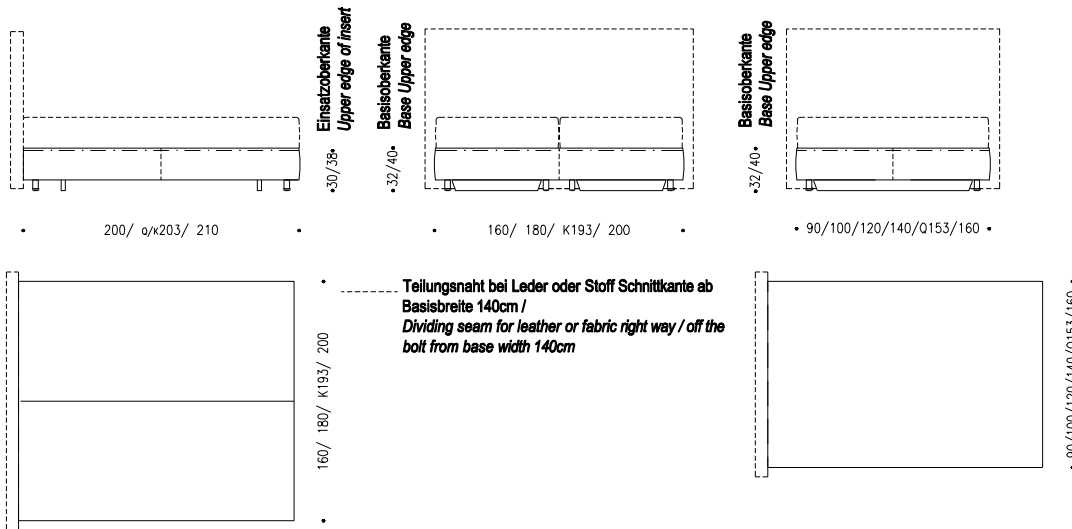

## Standard / Standard

Kufe / Runner 8cm

Kufe / Runner 16cm

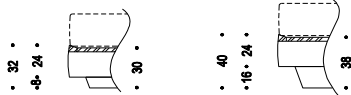

## Varianten / Variants

Cylinder 8cm

Cylinder 16cm

Organic 8cm

Organic 16cm



### Ausführungen:

<b>Basis:</b>	Holzkonstruktion
Breite	90, 100, 120, 140, 160, 180, 200 cm, US Queen, US King (Matratzenmaß)
Länge	200, 210 cm, US Queen, US King (Matratzenmaß)
Polsterung	Tonnentaschenfederkern, Polymousse, Vliesabdeckung
Bezug	Abnehmbar
Einsatz	Boxspring <sup>1</sup>
Fuß	Kufe schwarz <sup>2</sup>
Fußhöhe	8, 16 cm

<sup>1</sup> Breite 160 cm Einsatz durchgehend oder geteilt; ab Breite 180 cm Einsatz geteilt

<sup>2</sup> Standardausführung. Varianten gegen Aufpreis erhältlich.

### Configurations:

<b>Bed base:</b>	Wood construction
Width	90, 100, 120, 140, 160, 180, 200 cm, US Queen, US King (mattress dimensions)
Length	200, 210 cm, US Queen, US King (mattress dimensions)
Upholstery	Pocket spring, polyfoam, fleece covered
Covering	Removable
Insert	Boxspring <sup>1</sup>
Foot	Black runner <sup>2</sup>
Foot height	8, 16 cm

<sup>1</sup> Width 160 cm insert continuous or split; from 180 cm insert split

<sup>2</sup> Standard variant. Variants available for surcharge.

Falten sind design- verarbeitungs-, material-, bzw. benützungsbedingt und stellen keinen Reklamationsgrund dar.  
Wrinkles may occur due to design, treatment, quality of material and conditions of use and are no cause for claims.

# WITTMANN SPRING SLIM *Design: Wittmann Workshop (2021)*

873XX

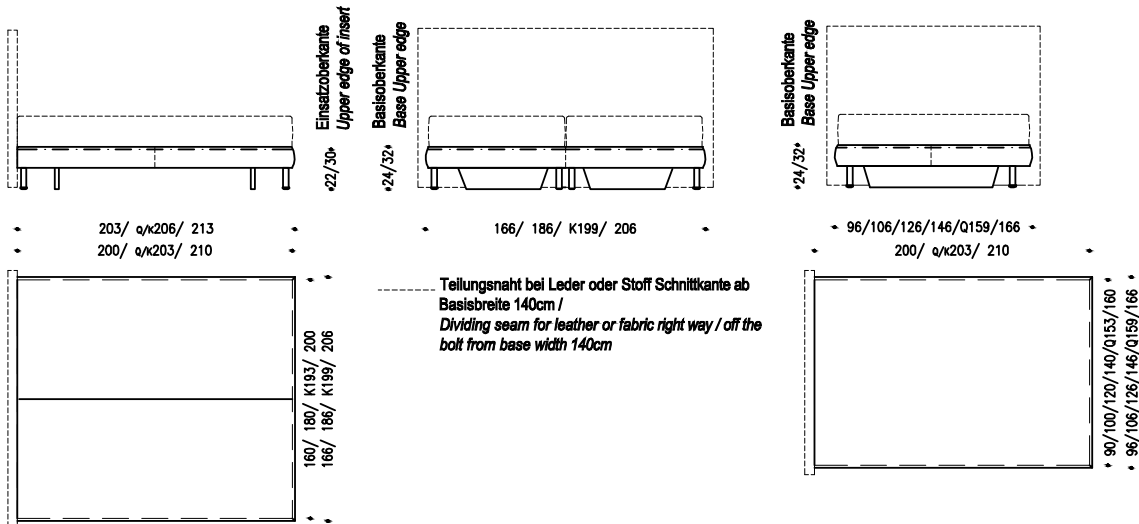

## Standard / Standard

Kufe / Runner 8cm      Kufe / Runner 16cm

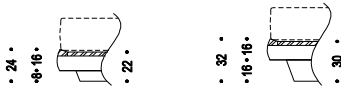

## Varianten / Variants

Cylinder 8cm      Cylinder 16cm      Organic 8cm      Organic 16cm

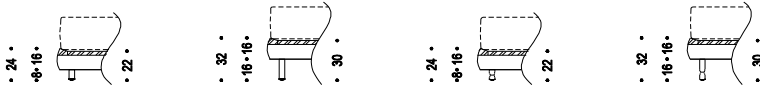

**Kopfteilmontage nur bodenstehend möglich**  
**Headboard mounting only possible floor standing**

### Ausführungen:

<b>Basis:</b>	Holzkonstruktion
Breite	90, 100, 120, 140, 160, 180, 200 cm, US Queen, US King (Matratzenmaß) <sup>1</sup>
Länge	200, 210 cm, US Queen, US King (Matratzenmaß)
Polsterung	Tonnentaschenfederkern, Polymousse, Vliesabdeckung <sup>1</sup>
Bezug	Abnehmbar
Einsatz	Boxspring <sup>1</sup>
Fuß	Kufe schwarz <sup>2</sup>
Fußhöhe	8, 16 cm

<sup>1</sup> Breite 160 cm Einsatz durchgehend oder geteilt; ab Breite 180 cm Einsatz geteilt

<sup>2</sup> Standardausführung. Varianten gegen Aufpreis erhältlich.

### Configurations:

<b>Bed base:</b>	Wood construction
Width	90, 100, 120, 140, 160, 180, 200 cm, US Queen, US King (mattress dimensions) <sup>1</sup>
Length	200, 210 cm, US Queen, US King (mattress dimensions)
Upholstery	Pocket spring, polyfoam, fleece covered <sup>1</sup>
Covering	Removable
Insert	Boxspring <sup>1</sup>
Foot	Black runner <sup>2</sup>
Foot height	8, 16 cm

<sup>1</sup> Width 160 cm insert continuous or split; from 180 cm insert split

<sup>2</sup> Standard variant. Variants available for surcharge.

Falten sind design- verarbeitungs-, material-, bzw. benützungsbedingt und stellen keinen Reklamationsgrund dar.  
 Wrinkles may occur due to design, treatment, quality of material and conditions of use and are no cause for claims.

# EINSÄTZE

## Inserts

### ALLGEMEINE INFORMATION:

- Maße:** ■ Die Längen der Einsätze werden den gewählten Basislängen 200 cm oder 210 cm angepasst und sind ohne Aufpreis frei wählbar. (Ausnahme Motoren-Einsatz)
- Maßangaben beziehen sich auf Matratzenmaße
- Bezug:** ■ Gepolsterte Einsätze sind mit Drell bezogen.
- Kompatibilität:** ■ Auch für Einsatz in Fremdbetten geeignet
- Matratzenvarianten:** ■ Einreihen-Lattenrost für Naturkautschukmatratze
- Gepolsterte Einsätze für Federkernmatratzen

### GENERAL INFORMATION:

- Dimensions:** ■ *The lengths of the inserts are adapted to the selected base length 200 cm or 210 cm and are freely selectable. (except for motor insert)*
- *Stated dimensions relate to mattress sizes.*
- Cover:** ■ *Upholstered inserts covered with drill.*
- Compatibility:** ■ *Also for usage with third party beds.*
- Mattress variants:** ■ *Single-row-slatted frame for Natural Rubber Mattress*
- *Upholstered inserts for pocket-spring-core mattresses*



# EINREIHEN-LATTENROST

## Single-row-slatted frame

902XX

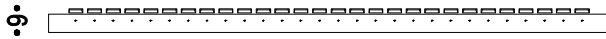

200/ K203/ 210  
Matratzenlänge/ Mattresses length  
-3cm

80/ 90/ K96,5/ 100/ 120/  
140

Matratzenbreite/ Mattress width  
-1,5cm

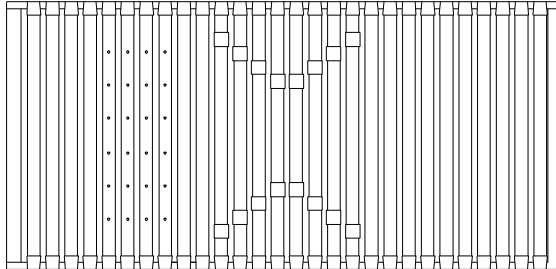

Schulterzone

Shoulder zone

Beckenkomfortzone stufenlos verstellbar  
Pelvic comfort zone continuously adjustable

### Ausführung / Configuration:

Einsatzhöhe: Einreihen-Lattenrost  
Insert height: Single-row-slatted frame

9 cm  
9 cm

# GEPOLSTERTE EINSÄTZE

## Upholstered Inserts

Comfort Einsatz / Insert

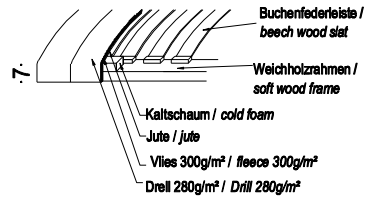
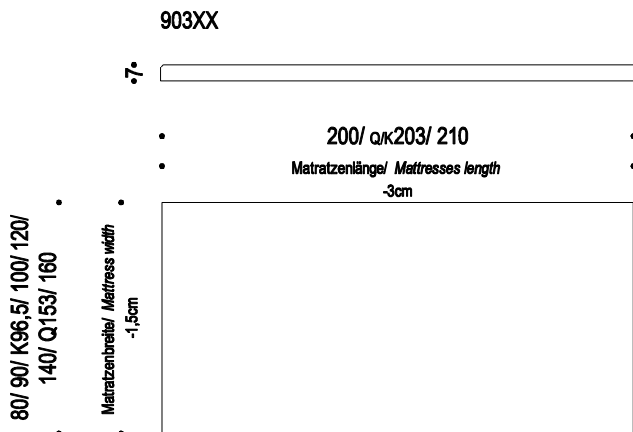

Superior Einsatz / Insert

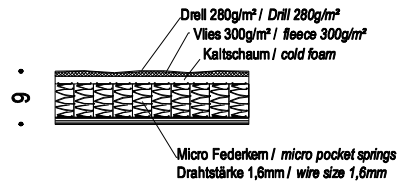
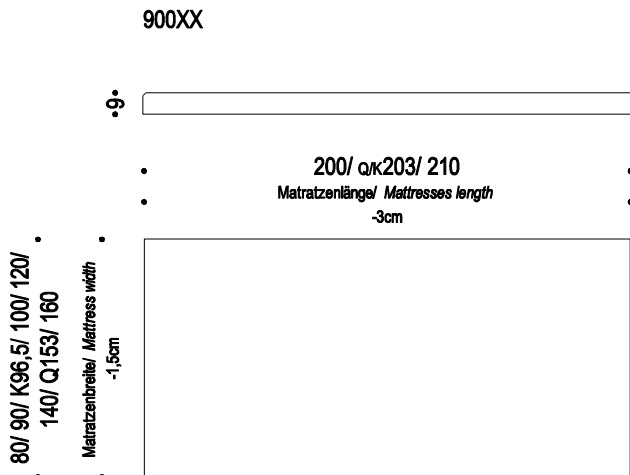

### Ausführung / Configuration:

Einsatzhöhe : Comfort: 7 cm  
Insert height : Superior: 9 cm

# MOTOREN-EINSATZ

## Motor Insert

901XX

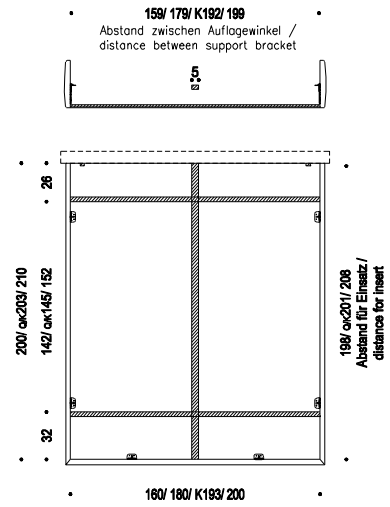
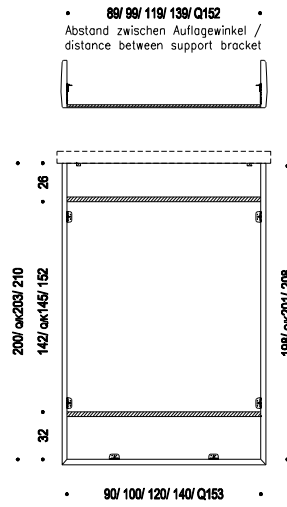
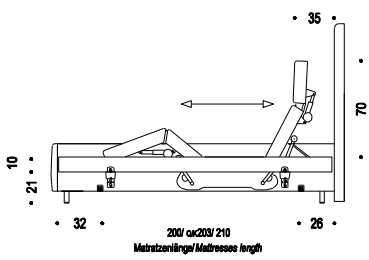
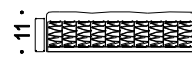
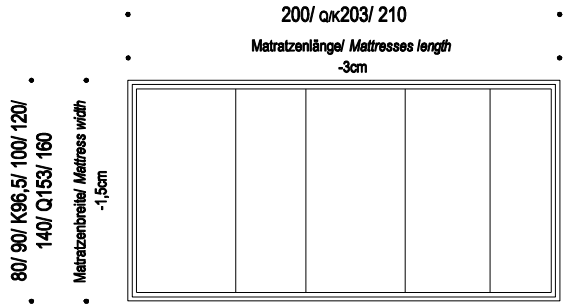
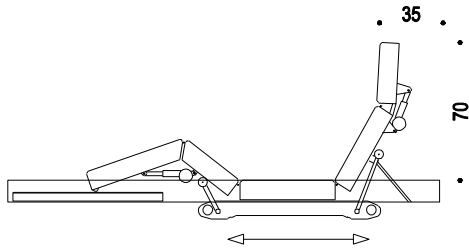

### Generelle Information - general information

Einsatzhöhe: 11 cm  
Insert height: 11 cm

# Matratzen und Auflagen

## *Mattresses and toppers*

### ALLGEMEINE INFORMATION:

- Maße:** ■ Standardlänge: 200 cm, auf Wunsch 210 cm Länge ohne Aufpreis.  
■ Maßabweichungen von max. 2 cm liegen im Toleranzbereich.  
■ Modelldetails, Aufbau und Zusammensetzungen laut technischer Beschreibung.
- Bezug:** ■ Wittmann Drell.
- Kompatibilität:** ■ Empfohlene Kombination für Taschenfederkernmatratzen: gepolsterte Einsätze.  
■ Empfohlene Kombination für Naturkautschukmatratzen: Einreihen-Lattenrost.
- Etiketten:** ■ Auf Anfrage personalisieren wir die Matratze durch Einsticken eines Monogramms auf dem Matratzenetikett (Siehe Beispiel unten).  
Bei Interesse wenden Sie sich an Ihre/n Wittmann Betreuer/in.

### GENERAL INFORMATION:

- Dimensions:** ■ *Standard length: 200 cm; 210 cm on request (without surcharge).*  
■ *Variations of up to 2 cm in dimensions within the normal tolerance range.*  
■ *Model details, structure and materials according to technical specifications.*
- Coverings:** ■ *Wittmann drill*
- Compatibility:** ■ *Recommended combination for pocket spring core mattress: upholstered insert.*  
■ *Recommended combination for a natural latex mattress: single-row-slatted frame.*
- Labels:** ■ *Upon request we can personalize the mattress by embroiding the customers initials on the mattress label (See example below).*  
*In case of interest, please contact your Wittmann representative.*

**Beispiel / Example:** ■

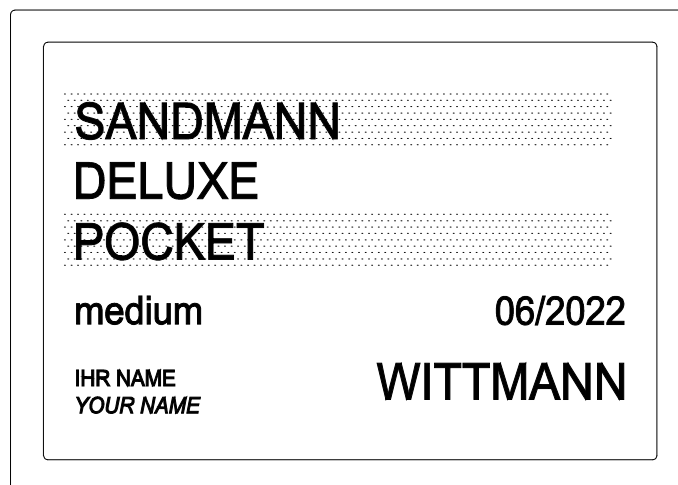

# NATURKAUTSCHUKMATRATZEN

## NATURAL RUBBER MATTRESSES

### Technische Beschreibung / Technical description:

Naturkautschukmatratze  
Natural rubber mattress:

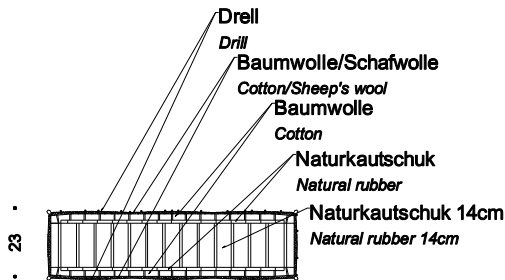

**Sommerseite**  
Drell 280g/m<sup>2</sup>  
Baumwolle 300g/m<sup>2</sup>  
Baumwolle 300g/m<sup>2</sup>  
Naturkautschuk  
Baumwolle 300g/m<sup>2</sup>  
Schafwolle 300g/m<sup>2</sup>  
Drell 280g/m<sup>2</sup>  
**Winterseite**

**Summer side**  
Drill 280g/m<sup>2</sup>  
Cotton 300g/m<sup>2</sup>  
Cotton 300g/m<sup>2</sup>  
Natural rubber  
Cotton 300g/m<sup>2</sup>  
Sheep's wool 300g/m<sup>2</sup>  
Drill 280g/m<sup>2</sup>  
**Winter side**

Naturkautschukmatratze mit Rosshaar  
Natural rubber mattress with horse hair

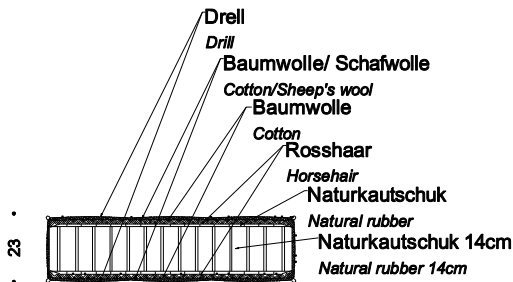

**Sommerseite**  
Drell 280g/m<sup>2</sup>  
Baumwolle 300g/m<sup>2</sup>  
Baumwolle 300g/m<sup>2</sup>  
Rosshaar  
Naturkautschuk  
Rosshaar  
Baumwolle 300g/m<sup>2</sup>  
Schafwolle 300g/m<sup>2</sup>  
Drell 280g/m<sup>2</sup>  
**Winterseite**

**Summer side**  
Drill 280g/m<sup>2</sup>  
Cotton 300g/m<sup>2</sup>  
Cotton 300g/m<sup>2</sup>  
Horsehair  
Natural rubber  
Horsehair  
Cotton 300g/m<sup>2</sup>  
Sheep's wool 300g/m<sup>2</sup>  
Drill 280g/m<sup>2</sup>  
**Winter side**

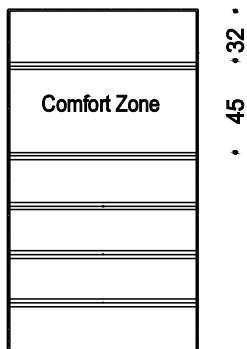

### COMFORT ZONE:

Im Matratzenoberteil sorgt ein flexibler nicht gehefteter Steppeinsatz für eine extra weiche Oberfläche im Schulterbereich.

*A flexible, uncrimped insert provides a soft surface and ensures adequate shoulder pressure absorption.*

Die von uns verarbeitete Baumwolle ist aus kontrolliert biologischem Anbau (kbA) zertifiziert nach dem Oeko Tex Standard 100.

*The cotton processed by us is from controlled organic cultivation (kbA) certified according to the Oeko Tex Standard 100.*

# SANDMANN POCKET 3

mit TASCHENFEDERKERN und COMFORT ZONE  
with pocket spring core and comfort zone

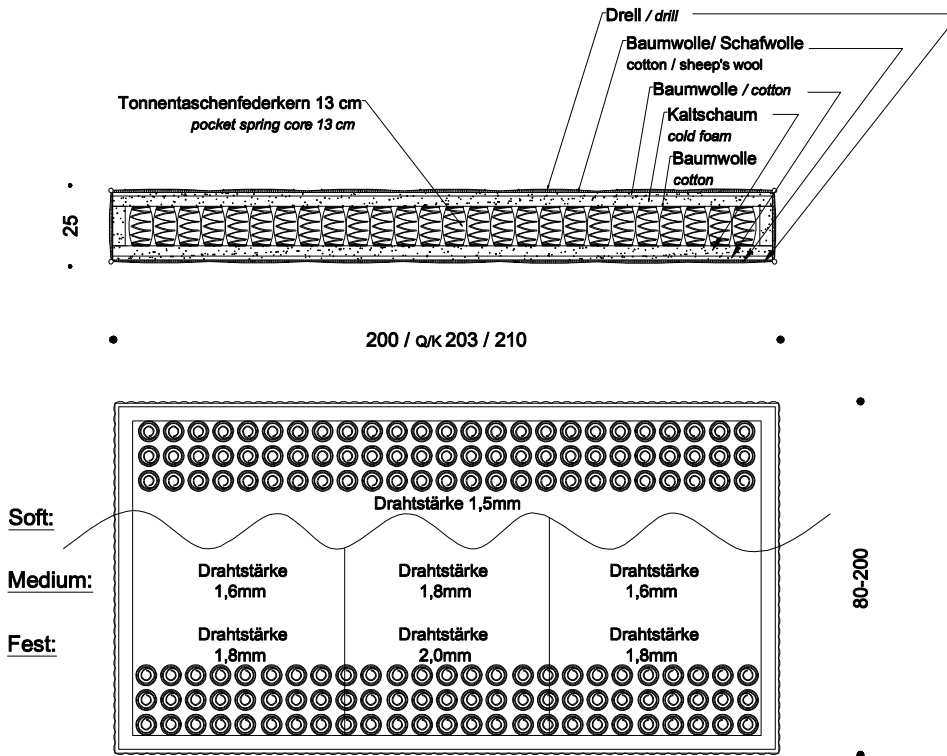

\* Die Festigkeit wird durch einen alternativen Polyaufbau erzielt.

\* The firmness is achieved through the use of different foam materials.

Fertigung von pro E-Motor Matratzen für Fremdlattenroste nicht möglich !

Production of pro E-Motor mattress for slatted frames not produced by Wittmann is not possible !

## COMFORT ZONE:

Im Matratzenoberteil sorgt ein flexibler nicht gehefteter Steppeinsatz für eine extra weiche Oberfläche im Schulterbereich.

*A flexible, uncrimped insert provides a soft surface and ensures adequate shoulder pressure absorption.*

## Technische Beschreibung:

### SOMMERSEITE

Drell 280g/m<sup>2</sup>  
kbA Baumwolle 300g/m<sup>2</sup>  
kbA Baumwolle 600g/m<sup>2</sup>  
Kaltschaum 30mm  
kbA Baumwolle 300g/m<sup>2</sup>  
Tonnentaschenfederkern  
kbA Baumwolle 300g/m<sup>2</sup>  
Kaltschaum 30mm  
kbA Baumwolle 600g/m<sup>2</sup>  
Schafwolle 300g/m<sup>2</sup>  
Drell 280g/m<sup>2</sup>

### WINTERSEITE

Die von uns verarbeitete Baumwolle ist aus kontrolliert biologischem Anbau (kbA) zertifiziert nach dem Oeko Tex Standard 100.

*The cotton processed by us is from controlled organic cultivation (kbA) certified according to the Oeko Tex Standard 100.*

## Technical description:

### SUMMER SIDE

Drill 280g/m<sup>2</sup>  
Cotton 300g/m<sup>2</sup>  
Cotton 600g/m<sup>2</sup>  
Polyurethane foams 35 mm  
Cotton 300g/m<sup>2</sup>  
Pocket springs  
Cotton 300g/m<sup>2</sup>  
Polyurethane foams 35 mm  
Cotton 600g/m<sup>2</sup>  
Sheep wool 300g/m<sup>2</sup>  
Drill 280g/m<sup>2</sup>

### WINTER SIDE

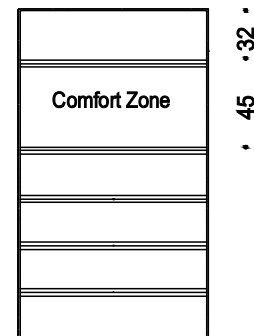

# SANDMANN DELUXE POCKET

mit TASCHENFEDERKERN  
with pocket spring core

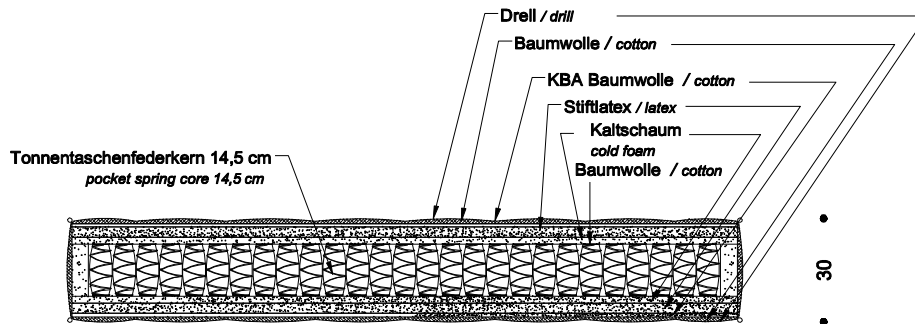

200 / Q/K 203 / 210

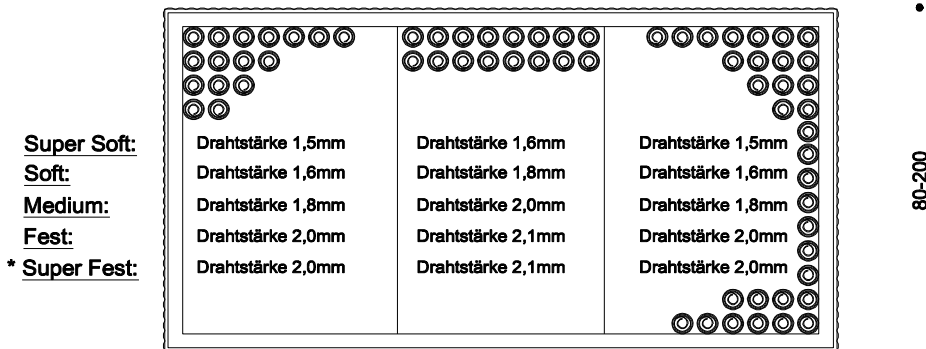

\* Die Festigkeit wird durch einen alternativen Polyaufbau erzielt.

\* The firmness is achieved through the use of different foam materials.

**Fertigung von pro E-Motor Matratzen für Fremdlattenroste nicht möglich !**

**Production of pro E-Motor mattress for slatted frames not produced by Wittmann is not possible !**

## Technische Beschreibung:

Drell 280 g / m<sup>2</sup>  
 kbA Baumwolle 300 g / m<sup>2</sup>  
 kbA Baumwolle 600 g / m<sup>2</sup>  
 Stiftlatex 30 mm  
 Kaltschaum 20 mm  
 kbA Baumwolle 300 g / m<sup>2</sup>  
 Tonnentaschenfedern  
 kbA Baumwolle 300 g / m<sup>2</sup>  
 Kaltschaum 20 mm  
 Stiftlatex 30 mm  
 kbA Baumwolle 600 g / m<sup>2</sup>  
 kbA Baumwolle 300 g / m<sup>2</sup>  
 Drell 280 g / m<sup>2</sup>

## Technical description:

Drill 280 g / m<sup>2</sup>  
 Cotton 300 g / m<sup>2</sup>  
 Cotton 600 g / m<sup>2</sup>  
 Latex 30 mm  
 Cold foam 20 mm  
 Cotton 300 g / m<sup>2</sup>  
 Pocket springs  
 Cotton 300 g / m<sup>2</sup>  
 Cold foam 20 mm  
 Latex 30 mm  
 Cotton 600 g / m<sup>2</sup>  
 Cotton 300 g / m<sup>2</sup>  
 Drill 280 g / m<sup>2</sup>

Die von uns verarbeitete Baumwolle ist aus kontrolliert biologischem Anbau (kbA) zertifiziert nach dem Oeko Tex Standard 100.

The cotton processed by us is from controlled organic cultivation (kbA) certified according to the Oeko Tex Standard 100.

# SANDMANN DELUXE POCKET

mit TASCHENFEDERKERN und COMFORT ZONE  
with pocket spring core and comfort zone

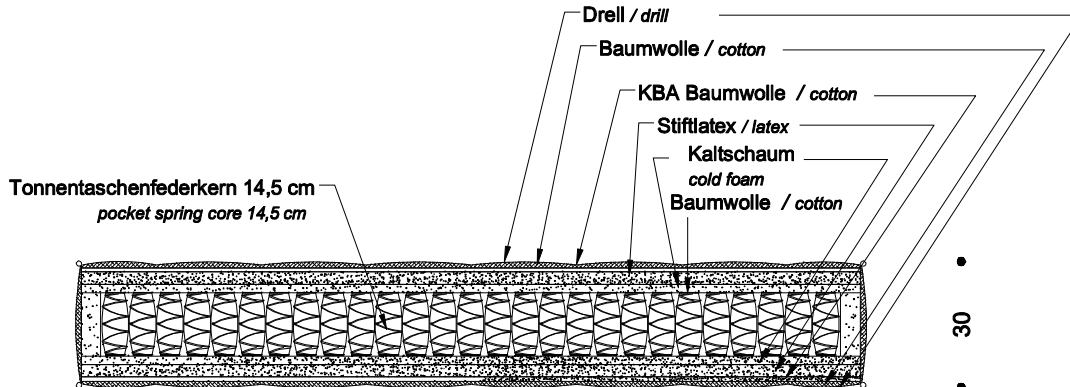

200 / ank 203 / 210

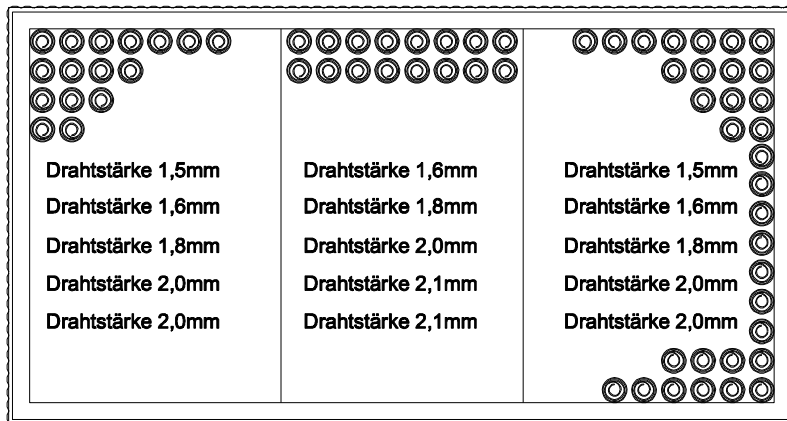

**Super Soft:**

**Soft:**

**Medium:**

**Fest:**

\* **Super Fest:**

Drahtstärke 1,5mm

Drahtstärke 1,6mm

Drahtstärke 1,8mm

Drahtstärke 2,0mm

Drahtstärke 2,0mm

Drahtstärke 1,6mm

Drahtstärke 1,8mm

Drahtstärke 2,0mm

Drahtstärke 2,1mm

Drahtstärke 2,1mm

Drahtstärke 1,5mm

Drahtstärke 1,6mm

Drahtstärke 1,8mm

Drahtstärke 2,0mm

Drahtstärke 2,0mm

80-200

\* Die Festigkeit wird durch einen alternativen Polyaufbau erzielt.

\* The firmness is achieved through the use of different foam materials.

Fertigung von pro E-Motor Matratzen für Fremdlattenroste nicht möglich !

Production of pro E-Motor mattress for slatted frames not produced by Wittmann is not possible !

## COMFORT ZONE:

Im Matratzenoberteil sorgt ein flexibler nicht gehefteter Steppeinsatz für eine extra weiche Oberfläche im Schulterbereich.

*A flexible, uncrimped insert provides a soft surface and ensures adequate shoulder pressure absorption.*

## Technische Beschreibung:

Drell 280 g / m<sup>2</sup>  
kbA Baumwolle 300 g / m<sup>2</sup>  
kbA Baumwolle 600 g / m<sup>2</sup>  
Kaltschaum 20 mm  
Latex 30 mm  
Tonnentaschenfedern  
Latex 30 mm  
Kaltschaum 20 mm  
kbA Baumwolle 600 g / m<sup>2</sup>  
kbA Baumwolle 300 g / m<sup>2</sup>  
Drell 280 g / m<sup>2</sup>

## Technical description:

Drill 280 g / m<sup>2</sup>  
Cotton 300 g / m<sup>2</sup>  
Cotton 600 g / m<sup>2</sup>  
Cold foam 20 mm  
Latex 30 mm  
Pocket springs  
Latex 30 mm  
Cold foam 20 mm  
Cotton 600 g / m<sup>2</sup>  
Cotton 300 g / m<sup>2</sup>  
Drill 280 g / m<sup>2</sup>

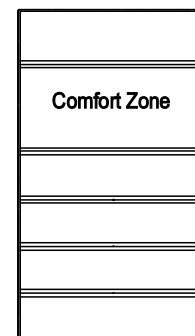

• 45 • 32 •

Die von uns verarbeitete Baumwolle ist aus kontrolliert biologischem Anbau (kbA) zertifiziert nach dem Oeko Tex Standard 100.

*The cotton processed by us is from controlled organic cultivation (kbA) certified according to the Oeko Tex Standard 100.*



# SANDMANN IMPERIAL POCKET

mit TASCHENFEDERKERN  
with pocket spring core

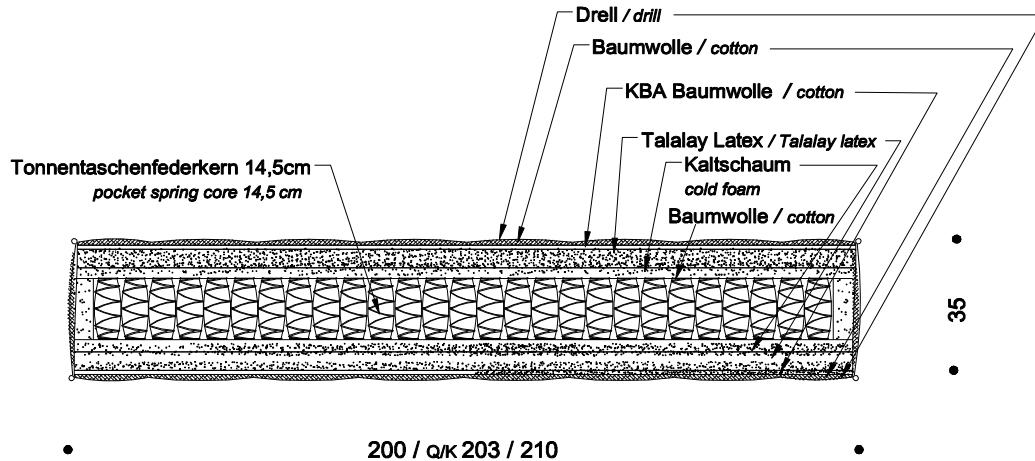

<b>Super Soft:</b>	Drahtstärke 1,5mm	Drahtstärke 1,6mm	Drahtstärke 1,5mm	80-200
<b>Soft:</b>	Drahtstärke 1,6mm	Drahtstärke 1,8mm	Drahtstärke 1,6mm	
<b>Medium:</b>	Drahtstärke 1,8mm	Drahtstärke 2,0mm	Drahtstärke 1,8mm	
<b>Fest:</b>	Drahtstärke 2,0mm	Drahtstärke 2,1mm	Drahtstärke 2,0mm	
<b>* Super Fest:</b>	Drahtstärke 2,0mm	Drahtstärke 2,1mm	Drahtstärke 2,0mm	

\* Die Festigkeit wird durch einen alternativen Polyaufbau erzielt.

\* The firmness is achieved through the use of different foam materials.

## Technische Beschreibung:

Drell 330 g / m<sup>2</sup>  
kbA Baumwolle 300 g / m<sup>2</sup>  
kbA Baumwolle 600 g / m<sup>2</sup>  
Talalay Latex 45 mm  
Kaltschaum 30 mm  
kbA Baumwolle 300 g / m<sup>2</sup>  
Tonnentaschenfedern  
kbA Baumwolle 300 g / m<sup>2</sup>  
Kaltschaum 30 mm  
Talalay Latex 45 mm  
kbA Baumwolle 600 g / m<sup>2</sup>  
kbA Baumwolle 300 g / m<sup>2</sup>  
Drell 330 g / m<sup>2</sup>

## Technical description:

Drill 330 g / m<sup>2</sup>  
Cotton 300 g / m<sup>2</sup>  
Cotton 600 g / m<sup>2</sup>  
Talalay Latex 45 mm  
Cold foam 30 mm  
Cotton 300 g / m<sup>2</sup>  
Pocket springs  
Cotton 300 g / m<sup>2</sup>  
Cold foam 30 mm  
Talalay Latex 45 mm  
Cotton 600 g / m<sup>2</sup>  
Cotton 300 g / m<sup>2</sup>  
Drill 330 g / m<sup>2</sup>

Die von uns verarbeitete Baumwolle ist aus kontrolliert biologischem Anbau (kbA) zertifiziert nach dem Oeko Tex Standard 100.

The cotton processed by us is from controlled organic cultivation (kbA) certified according to the Oeko Tex Standard 100.

# SANDMANN IMPERIAL POCKET

mit TASCHENFEDERKERN und COMFORT ZONE  
with pocket spring core and comfort zone

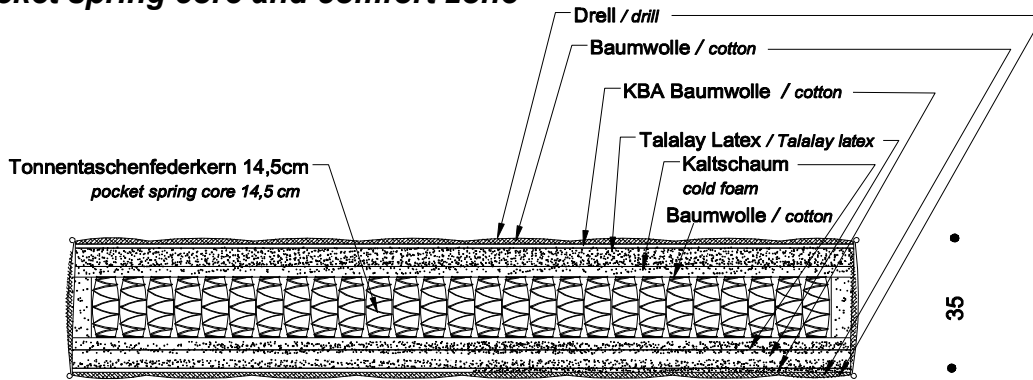

200 / Q/K 203 / 210

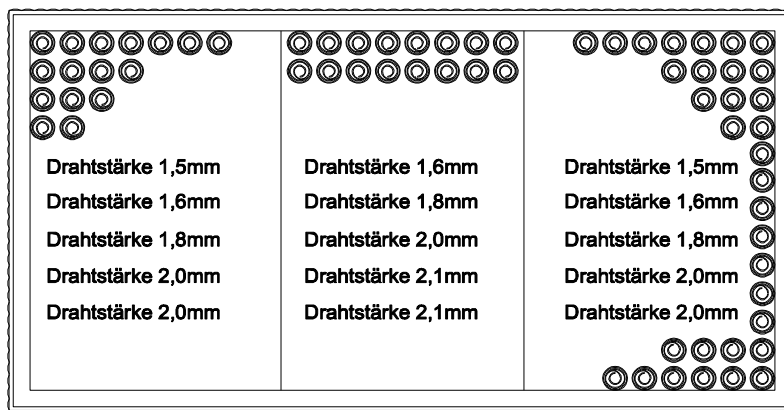

\* Die Festigkeit wird durch einen alternativen Polyaufbau erzielt.

\* The firmness is achieved through the use of different foam materials.

## COMFORT ZONE:

Im Matratzenoberteil sorgt ein flexibler nicht gehefteter Steppeinsatz für eine extra weiche Oberfläche im Schulterbereich.

A flexible, uncrimped insert provides a soft surface and ensures adequate shoulder pressure absorption.

### Technische Beschreibung:

Drell 330 g / m<sup>2</sup>  
 kbA Baumwolle 300 g / m<sup>2</sup>  
 Baumwollnessel  
 kbA Baumwolle 600 g / m<sup>2</sup>  
 Talalay Latex 45 mm  
 Kaltschaum 30 mm  
 kbA Baumwolle 300 g / m<sup>2</sup>  
 Trikot  
 Tonnentaschenfedern  
 Trikot  
 kbA Baumwolle 300 g / m<sup>2</sup>  
 Kaltschaum 30 mm  
 Talalay Latex 45 mm  
 kbA Baumwolle 600 g / m<sup>2</sup>  
 Baumwollnessel  
 kbA Baumwolle 300 g / m<sup>2</sup>  
 Drell 330 g / m<sup>2</sup>

### Technical description:

Drill 330 g / m<sup>2</sup>  
 Cotton 300 g / m<sup>2</sup>  
 Cotton fabric  
 Cotton 600 g / m<sup>2</sup>  
 Talalay Latex 45 mm  
 Cold foam 30 mm  
 Cotton 300 g / m<sup>2</sup>  
 Trickot  
 Pocket springs  
 Trickot  
 Cotton 300 g / m<sup>2</sup>  
 Cold foam 30 mm  
 Talalay Latex 45 mm  
 Cotton 600 g / m<sup>2</sup>  
 Cotton fabric  
 Cotton 300 g / m<sup>2</sup>  
 Drill 330 g / m<sup>2</sup>

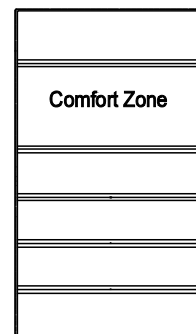

Die von uns verarbeitete Baumwolle ist aus kontrolliert biologischem Anbau (kbA) zertifiziert nach dem Oeko Tex Standard 100.

The cotton processed by us is from controlled organic cultivation (kbA) certified according to the Oeko Tex Standard 100.

# ZIPPVERBINDUNG

## Zipper

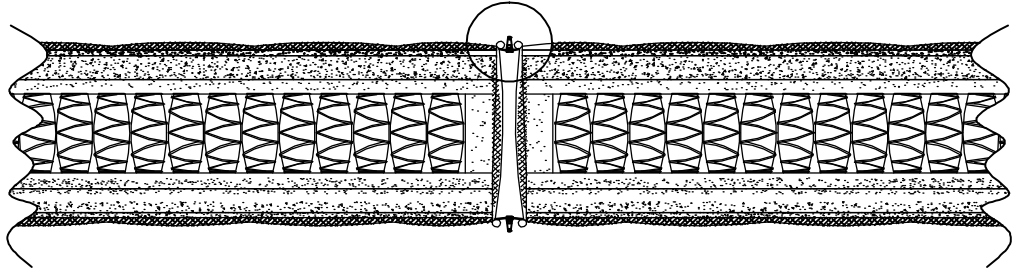
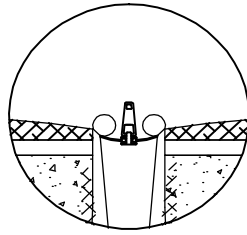

Für Matratzenbreiten 80, 90, 100 cm verfügbar.

Zipperverbindung wird auf vier Seiten angebracht, so dass ein Wenden der Matratzen möglich ist.

Auch bei zwei Matratzen mit verschiedenen Härtegraden möglich.

*Available for mattress width 80, 90, 100 cm.*

*Zipper is mounted on four sides, so that a turning of the mattresses is possible.*

*Also possible for two mattresses with different hardness grades.*

# MATRATZENAUFBLAGE EDEN

## Mattress topper EDEN

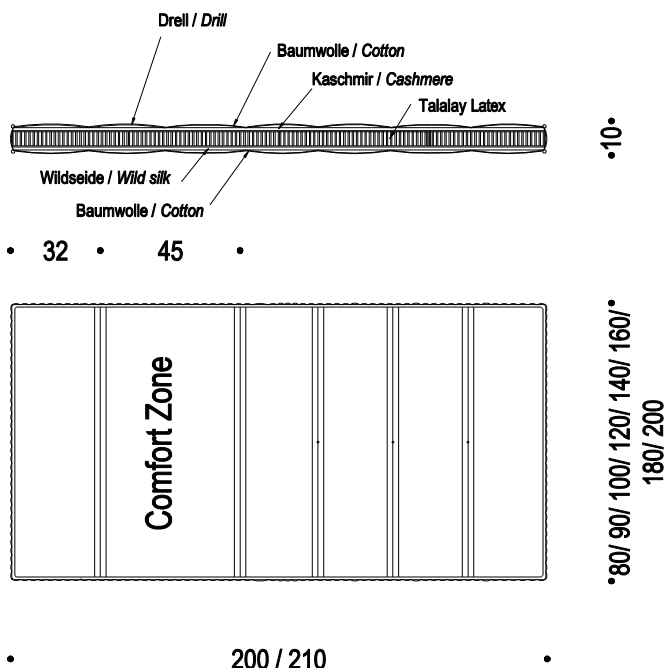

Zur Ruhe kommen, sanft einsinken und in eine Welt der vollkommenen Entspannung abtauchen: Eden hat einen hohen Kern aus hochwertigem Talalay Latex, der auf der Sommerseite von einer Schicht Wildseide und auf der Winterseite von Kaschmir umschlossen wird. Eine perfekte Ganzjahresauflage.

*Come to rest, gently sink in and dive into a world of complete relaxation: The Eden mattress topper with its thick core of high-quality Talalay latex is surrounded by a layer of wild silk on the summer side and cashmere on the winter side. A perfect year-round topper.*

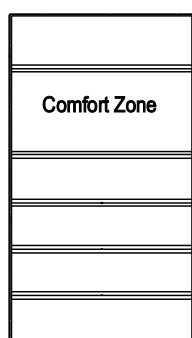

### **COMFORT ZONE:**

Im Matratzenoberteil sorgt ein flexibler nicht gehefteter Steppeinsatz für eine extra weiche Oberfläche im Schulterbereich.

*A flexible, without stitching insert provides a soft surface and ensures adequate shoulder pressure absorption.*

Die von uns verarbeitete Baumwolle ist aus kontrolliert biologischem Anbau (kbA) zertifiziert nach dem Oeko Tex Standard 100.

*The cotton processed by us is from controlled organic cultivation (kbA) certified according to the Oeko Tex Standard 100.*

# MATRATZENAUFLAGE PRINCESS

## Mattress topper PRINCESS

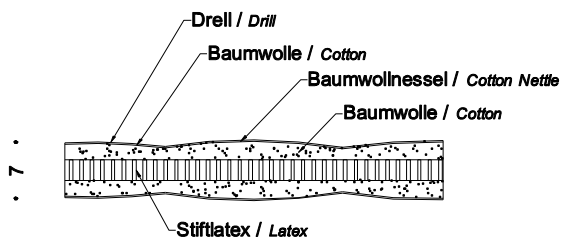

Die natürliche Elastizität des luftdurchlässigen Latexkerns gibt dieser Auflage eine besonders weiche Oberfläche und garantiert optimale Muskel- und Gelenksentspannung in jeder Schlafposition. Mit der Princess Auflage wird das perfekte Schlafsystem komplett. Die darunter liegende Matratze gibt die individuell gewünschte Festigkeit und Stütze. Die Ergänzung um eine der klimaregulierenden Auflagen schafft letztlich eine Kombination, die nicht nur höchstmögliche Individualität bedeutet, sondern ein Luxus ist, den man sich im Sinne des perfekten Schlafes gönnen soll.

*The natural elasticity of the air permeable latex core gives this topper a particularly soft surface and guarantees optimal muscle and joint relaxation in every sleeping position. With the Princess topper, the perfect sleeping system is made complete: the underlying mattress gives the individually desired firmness and support. The addition of the Princess topper ultimately creates a combination that not only means the highest possible individuality, but also a luxury that you should treat yourself to for the perfect sleep.*

**Um das individuell gewünschte Schlafklima zu erreichen, können die Komforteigenschaften der Auflage Princess durch den zusätzlichen Einsatz einer der auf den folgenden Seiten vorgestellten Auflagen ergänzt werden.**

***In order to attain the individually desired sleep climate, the comfort of the Princess topper can be supplemented by one of the toppers presented on the following pages.***

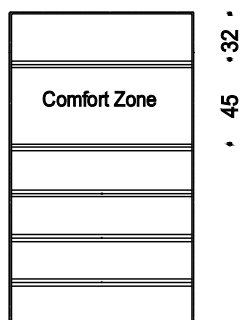

### **COMFORT ZONE:**

Im Matratzenoberteil sorgt ein flexibler nicht gehefteter Steppeinsatz für eine extra weiche Oberfläche im Schulterbereich.

*A flexible, without stitching insert provides a soft surface and ensures adequate shoulder pressure absorption.*

**Die von uns verarbeitete Baumwolle ist aus kontrolliert biologischem Anbau (kbA) zertifiziert nach dem Oeko Tex Standard 100.**

***The cotton processed by us is from controlled organic cultivation (kbA) certified according to the Oeko Tex Standard 100.***

# MATRATZENAUFLAGEN

## Mattress topper



### 100% Kaschmir / 100% Cashmere

Die kostbare Unterwolle der Kaschmirziege wird in einem aufwendigen Verfahren ausgekämmt und selektiert. Das Flaumhaar ist unübertroffen fein, geschmeidig und leicht. Kaschmir ist eine der hochwertigsten Naturfasern mit unverwechselbarem, weichem Griff und sehr guter Wärmedämmung.

*The precious undercoat of the Cashmere goat is combed out and carefully selected. The fluff hair is unsurpassed in its fineness and is feather light. Cashmere is one of the highest quality natural fibers with a velvety soft touch and very good thermal insulation.*



### 100% Merinowolle / 100% Merino wool

Die Wolle des Merinoschafs hat hohe Wärmedämm- und Speichereigenschaften. Sie kann Wasserdampf aufnehmen, ohne sich feucht anzufühlen und leitet Feuchtigkeit schneller ab, als vergleichbare Naturfasern.

*The wool of the Merino sheep has high thermal insulation and storage properties. It can absorb water vapor without feeling wet and allows moisture to evaporate faster than comparable natural fibers.*



### 100% Wildseide / 100% Wild silk

Gewonnen aus den Kokons der Seidenraupe, ist Wildseide mit ihrer unregelmäßigen Oberfläche die einzige in der Natur vorkommende Endlosfaser. Sie wirkt isolierend und kann bis zu einem Drittel ihres Eigengewichts an Feuchtigkeit aufnehmen.

*Obtained from the cocoons of the silkworm, wild silk with its irregular surface is the only naturally occurring continuous fiber. It has an insulating effect and can absorb up to one third of its own weight in moisture.*

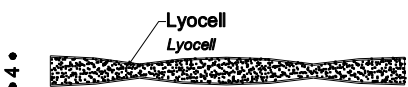

### 60% Lyocellfaser, 40% Polyester / 60% Lyocell fiber, 40% Polyester

Lyocell lässt Allergiker aufatmen. Die Faser – auch als Tencel® bekannt – wird aus Holz aus nachhaltiger Forstwirtschaft gewonnen und ist biologisch abbaubar. Lyocell hat eine glatte Oberfläche mit seidigem Griff und begehrte hygienische Eigenschaften: die Faser nimmt Feuchtigkeit auf und transportiert sie nach außen. Es entsteht somit kein Feuchtigkeitsfilm, der Grundlage für Bakterienbildung wäre. Lyocell ist zudem äußerst reißfest und damit ein sehr langlebiges Material. Durch die spezielle Zusammensetzung des Materials waschbar bis maximal 60°C. Einsprung bis zu 5% ist möglich.

*Lyocell lets allergy sufferers feel relieved. The fiber - also known as Tencel® - is extracted from wood from sustainable forestry and is biodegradable. Lyocell has a smooth surface with a silky feel and very specific hygienic qualities: the fiber absorbs moisture and moves it to the surface. Hence, there is no resulting moisture film, which could be the source for the development of bacteria. Lyocell is also extremely tearproof and therefore a very durable material. Due to the special composition of the material, it can be washed at maximum 60°C. Shrinkage up to 5% is possible.*

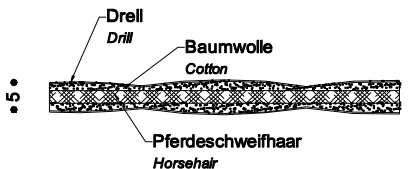

Die von uns verarbeitete Baumwolle ist aus kontrolliert biologischem Anbau (kbA) zertifiziert nach dem Oeko Tex Standard 100.

*The cotton processed by us is from controlled organic cultivation (kbA) certified according to the Oeko Tex Standard 100.*

### 100% Rosshaar / 100% Horse hair

Für die Füllung kommt ausschließlich das hochwertige Schweifhaar des Pferdes zur Verwendung, woraus sich eine elastische, federnde und dadurch anpassungsfähige Auflage ergibt. Durch die Kräuselung bleibt die Auflage luftdurchlässig, was wiederum einen eventuellen Wärmestau verhindert. Die oberste Schicht auf beiden Seiten besteht aus Baumwolle, die der Auflage eine angenehme Weichheit gibt und die feuchtigkeitsregulierende Eigenschaften unterstützt. Die besonderen Eigenschaften von Rosshaar in Verbindung mit der atmungsaktiven offenporigen Baumwolle erlaubt das gelegentliche Austreten einzelner Rosshaare, die händisch einfach entfernt werden können.

*For the filling, the high-quality hair from the tail of the horse is used exclusively which gives an elastic, resilient topper. The rippling allows the topper to remain breathable which prevents heat accumulation. A luxurious layer of cotton encloses both sides of the core, which ensures a pleasant softness and supports moisture control. The special characteristics of horsehair in combination with the breathable, open-pored cotton allows the occasional passing-through of individual horsehairs, which can be removed easily by hand.*